

NESPRESSO®

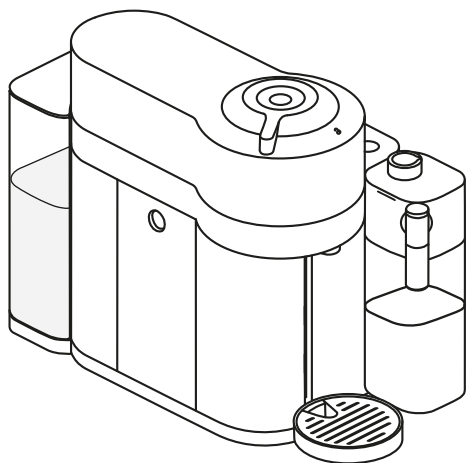

VERTUO
LATTISSIMA

DeLonghi



INSTALLATION

1. Machine overview	3
2. Packaging content	7
3. Connectivity	7
4. Water hardness setting	8
5. Open/close	10
6. Disassembling the milk carafe	10
7. Assembling the milk carafe	11
8. Cleaning the milk carafe	12
9. First use	13

USE

10. Coffee Preparation	15
11. Milk Preparation & Daily rinsing	17
12. Milk recipes	22

SETTINGS

13. Energy saving	25
14. Setting the coffee volume	26
15. Reset to factory settings	26
16. Turn on/off Bluetooth & Wi-Fi	27

MAINTENANCE

17. Emptying the system before a period of non-use	28
18. After a long period of non-use	30
19. Cleaning cycle	32
20. Descaling	35
21. Troubleshooting	38

TECHNICAL SPECIFICATIONS

22. Specifications	41
23. Disposal and environmental protection	41

1 OVERVIEW

Overview of machine

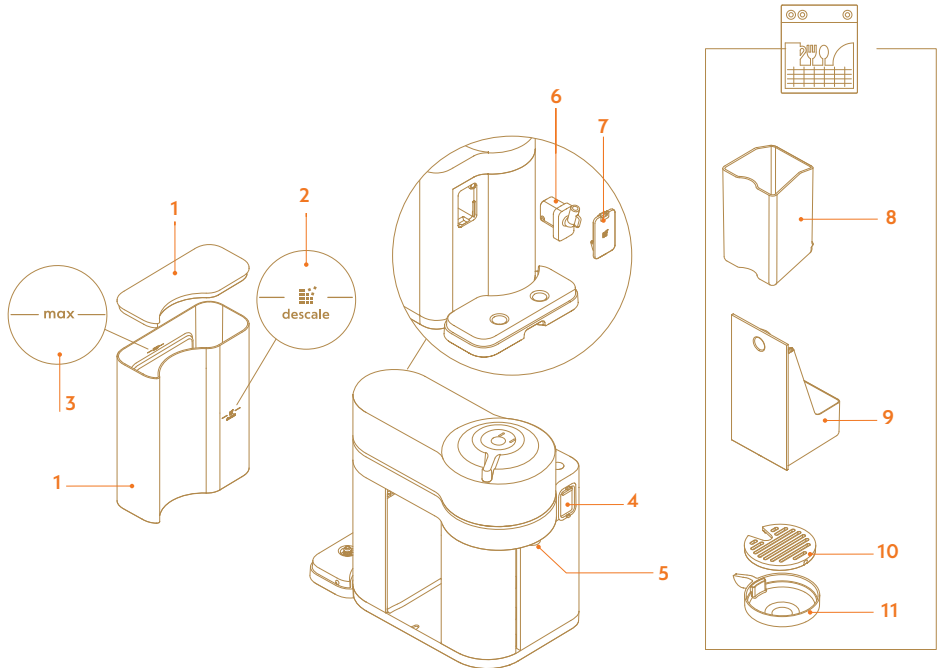

- 1 Water tank and lid
- 2 Descale mark
- 3 Maximum level mark
- 4 Milk carafe connector door
- 5 Coffee outlet
- 6 Descaling pipe

- 7 Descaling pipe cover
- 8 Used capsule container
- 9 Drip tray
- 10 Drip grid
- 11 Adjustable cup support

Overview of display

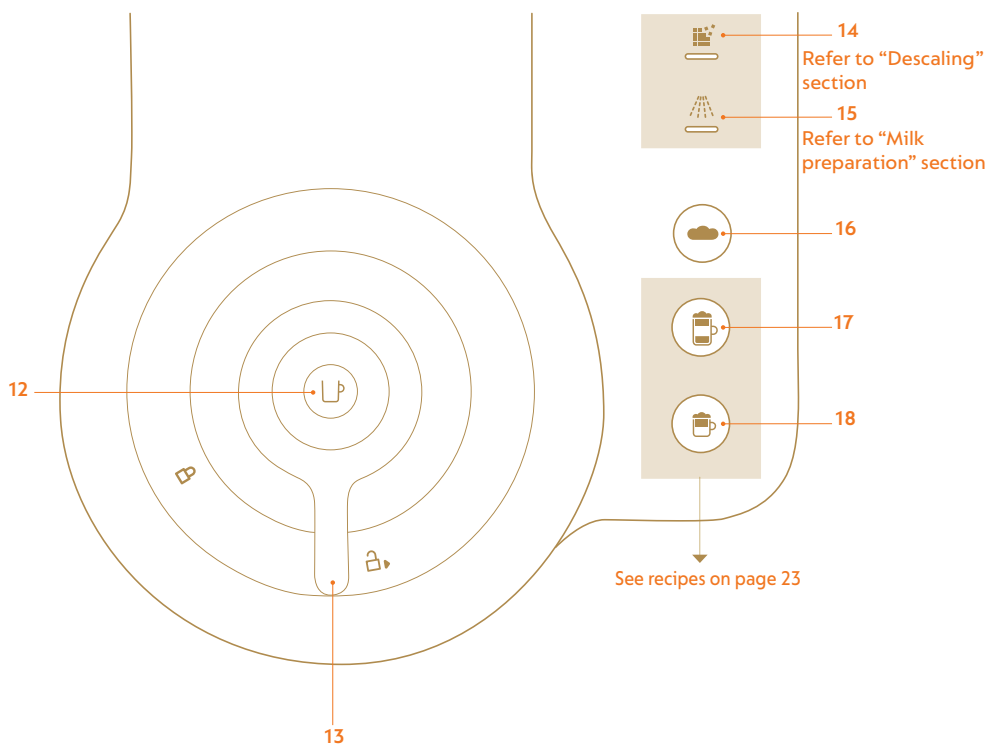

- 12 Coffee button - ON/OFF
- 13 Locking / Unlocking lever
- 14 Descale alert
- 15 Rinse alert

- 16 Hot foam button
- 17 Latte macchiato button
- 18 Cappuccino button

i Unboxing: some dust may be present on the surface of the machine due to the recycled materials used in the packaging. This is not dangerous, simply clean with a soft clean damp cloth.

Overview of milk carafe

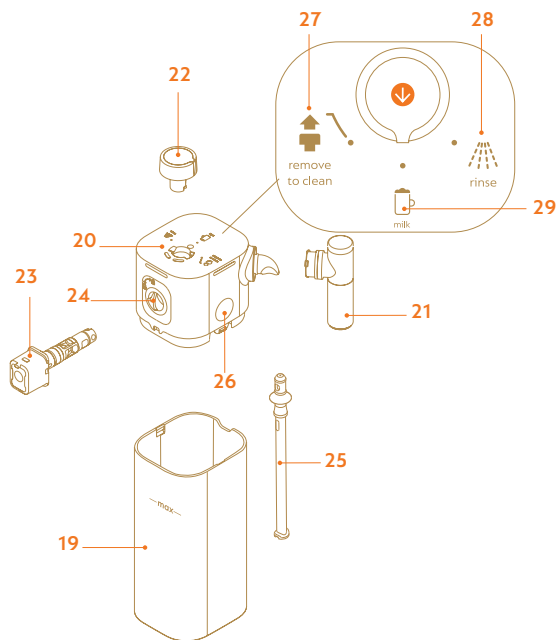

19 Milk carafe

20 Milk carafe lid

21 Milk spout

22 Milk action knob

23 Milk carafe connector

24 Connector housing

25 Milk aspiration tube

26 Lid removal button

27 Remove to clean position

28 Rinsing position

29 Milk recipe position

SAFETY

CAUTION: Before operating your coffee machine, please refer to the safety instructions leaflet to avoid possible harm and damage.



HELP

www.nespresso.com/help



THANK YOU FOR CHOOSING
NESPRESSO.

FOLLOW THESE INSTRUCTIONS OR GO ONLINE FOR THE FULL
USER MANUAL AT WWW.NESPRESSO.COM/HELP .

2 Package content

1. Coffee machine
2. Nespresso welcome material
3. Nespresso capsules box
4. Safety instructions
5. Quick start guide + Water hardness test strip
6. Warranty

3 Connectivity

BENEFITS OF CONNECTING YOUR MACHINE

Smart Coffee: Enjoy the latest coffee innovations from Nespresso by always keeping your machine up to date.

Expert advices: Receive real-time tips thanks to step-by-step features such as descaling, rinsing & cleaning your machine.

Machine care: Get support and tutorials for your machine care via your smartphone.

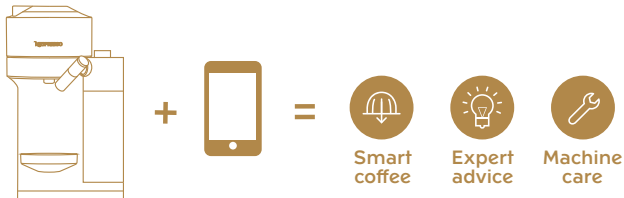

How to connect your machine:

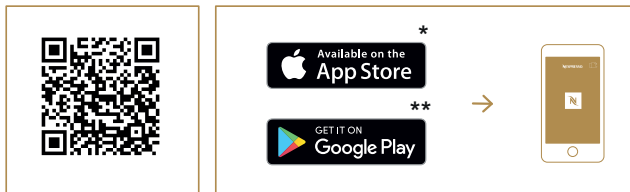

1. Download the Nespresso App.
2. Launch the App on your smartphone or tablet.
3. Click on the Machine icon.
4. Follow the instructions via the App.

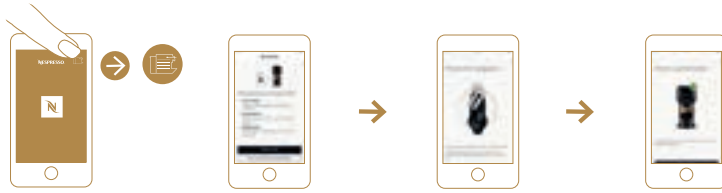

- * AppStore® is a trademark of Apple Inc., registered in the U.S. and other countries.
- ** Google Play and the Google Play logo are trademarks of Google LLC.

4 Water hardness setting

1. Take the water hardness test strip in the quick start guide and place it under water for 1 second. Wait about one minute before reading test result.





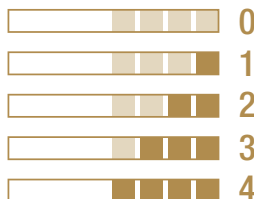



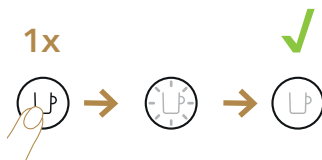







2. The number of red squares indicates the water hardness level.



3. Plug the power cord.
4. Make sure that no accessory (milk carafe or descaling pipe) is connected to the milk carafe connector door.
5. Turn the machine on.



6. Press hot foam button  for three seconds to enter the menu mode.
7. Clean and descale alerts blink together.
8. Press cappuccino button , the system proposes one out of the five combinations. If the selection is not done within 15 sec., it exits automatically.
9. Set the hardness level by pressing the corresponding button in below table (within 15 seconds).

Water hardness	Button to press	fH	dH	CaCO ₃
		< 5	< 3	< 50mg/l
		> 7	> 4	> 70mg/l
		> 13	> 7	> 130mg/l
	 + 	> 25	> 14	> 250mg/l
	 + 	> 38	> 21	> 380mg/l

10. The buttons blink three times rapidly to confirm new setting.
11. The machine is now reprogrammed with the new water hardness setting and turns automatically in ready mode.

 **NOTE:** Programming the machine according to the actual hardness of the local water supply warrants its lifetime and it needs to be descaled less often.

5 Open/close

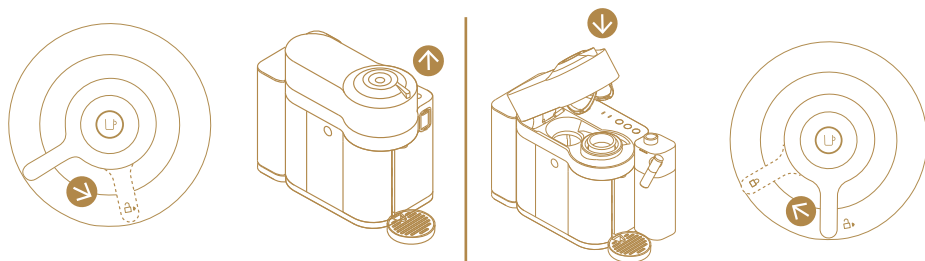

6 Disassembling the milk carafe

1. Press lid button to remove the lid from the milk carafe. Disconnect the aspiration tube. Turn the milk spout counter clockwise and pull it off.

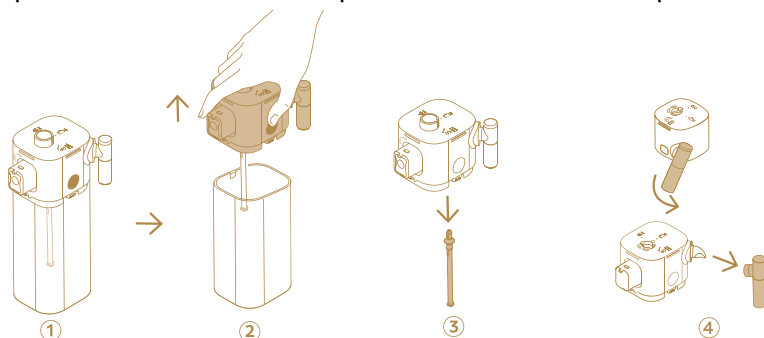

2. Turn the milk carafe connector towards the unlock position  and pull it out. Turn the knob to “remove to clean” position and pull it out.

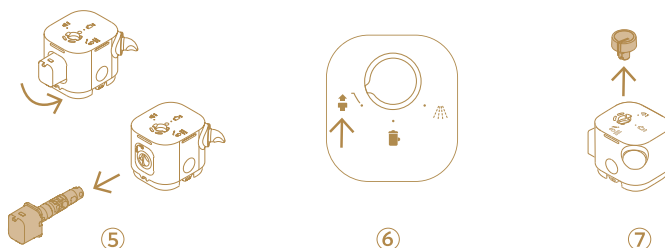

7 Assembling the milk carafe

1. Insert correctly the milk carafe connector into the milk carafe lid and turn it clockwise towards the lock position . Insert the milk spout. Insert the knob and turn it to the “milk” position.

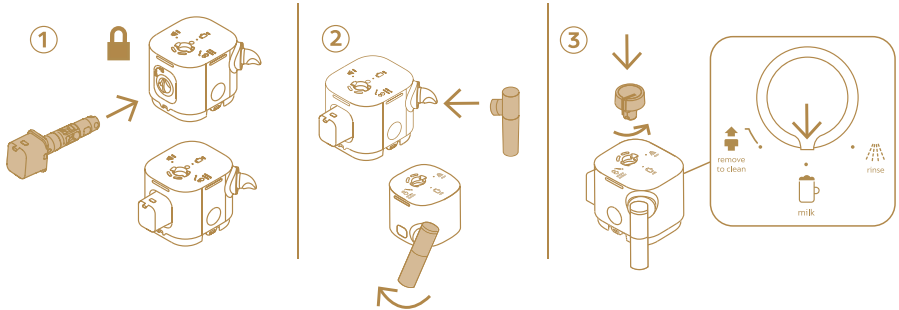

2. Insert the aspiration tube until its circular lip touches the bottom of the carafe lid. Plug the milk carafe lid to the milk carafe.

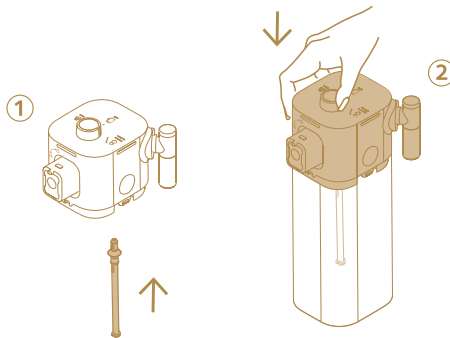

8 Cleaning the milk carafe

1. Disassemble the milk carafe. Refer to section “Disassembling the milk carafe”.
2. **If a dishwasher is available:** place all milk carafe components in the upper part of your dishwasher.
If a dishwasher is not available: soak all components in hot potable water (50°C / 122°F) together with a mild detergent for at least 30 minutes; then rinse thoroughly with hot potable water (50°C / 122°F). Do not use scented detergents.



3. Clean the interior of the milk carafe, the milk spout and the knob with a mild detergent and rinse with hot potable water.
* Make sure the Air inlet is clean, this will ensure beverage quality cup after cup.
Do not use abrasive material that might damage the surface of the equipment.
4. Dry all six components with a clean cloth and reassemble. Refer to section “Assembling the milk carafe”.

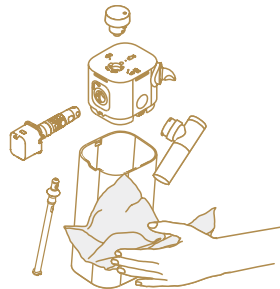

- i** After cleaning the milk carafe, if you still have issues with your milk frothing performance, please proceed with a second rinsing cycle by turning the knob to the rinsing position.
- i** The procedure must be performed after each use. Dishwashing is recommended. When a dishwasher is not available, the milk carafe components can be washed by hand.

9 First use

1. Rinse the water tank before filling with only fresh potable water up to the maximum level.

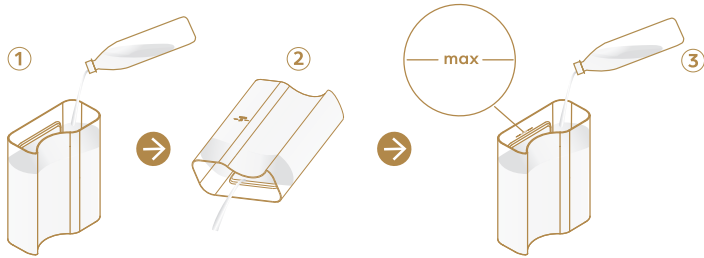

2. Put the water tank back in position. Plug the power cord and place a container under the coffee outlet. Ensure the lever is in the lock position .

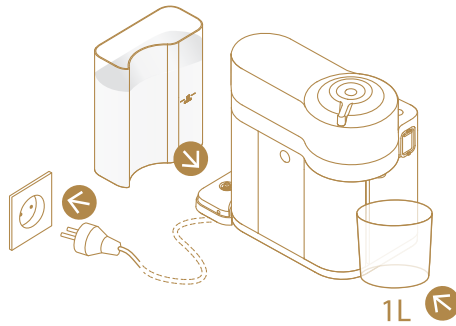

3. Turn on your machine.

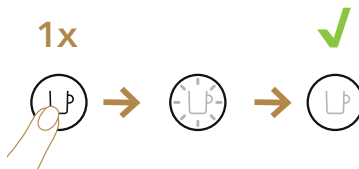

4. Press the coffee button three times within 2 seconds.



5. The machine will start rinsing. The cleaning procedure will run automatically for 5 minutes.

i NOTE: water may accumulate inside the machine's head during cleaning. If this happens please dry visible parts with a clean dry cloth.

6. Disassemble the milk carafe and clean all six components in the top rack of your dishwasher. In case a dishwasher is not available, refer to "Cleaning the milk carafe" section.

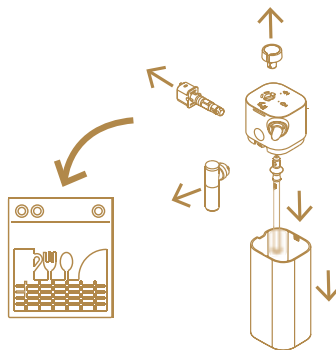

7. Then reassemble all six dried components and re-attach the milk carafe to the machine (refer to "Assembling / Disassembling the milk carafe" section).

8. Your machine is now ready to use.

⚠ CAUTION: first read the safety precautions to avoid risks of fatal electric shock and fire. Please ensure ground continuity when plugging the machine in the power outlet.

i NOTE: to turn off the machine, press and hold the ON-OFF/Coffee button until it switches off.

i When unpacking the machine, remove the plastic film, water tank and cup support. Adjust the cable length and store the excess in the cable guide under the machine.

10 Coffee preparation

1. Fill the water tank with only fresh potable water.

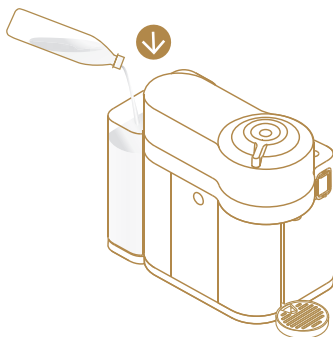

2. Turn the lever towards the unlock position  (1) and insert a capsule (2).

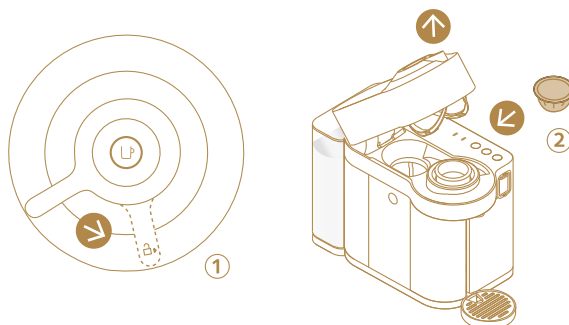

3. Close the machine by turning the lever (1) until the lock position  (2). Place a cup on the support (3). Cup support height can be adjusted to accommodate your cup size.

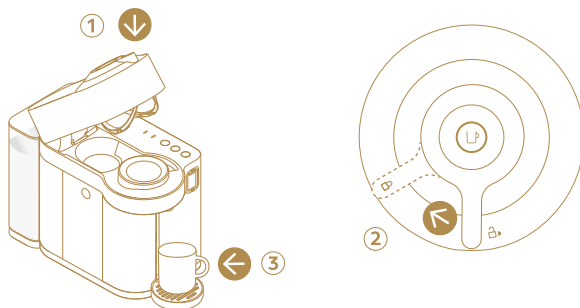

4. The coffee button starts blinking, as soon as light is steady white, press coffee button to start the coffee brewing.

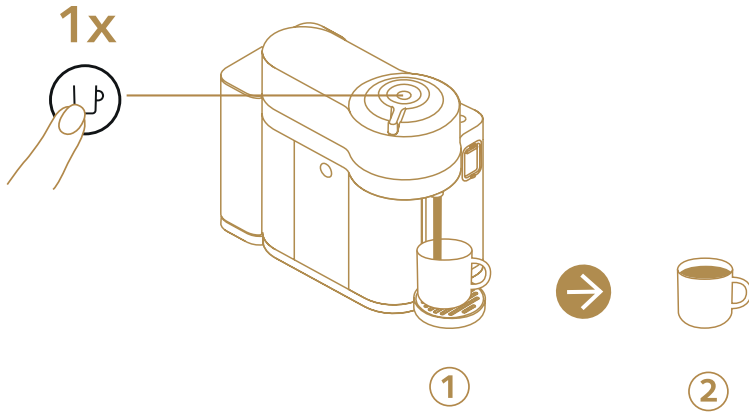

5. When the coffee stops brewing, turn the lever towards the unlock position  to open the machine and eject the capsule. Then close it.

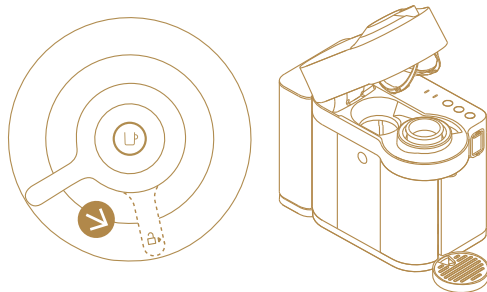

11

Milk Preparation & Daily Rinsing

1. Fill the water tank only with fresh potable water up to the “MAX” level before preparing a coffee or a milk recipe.

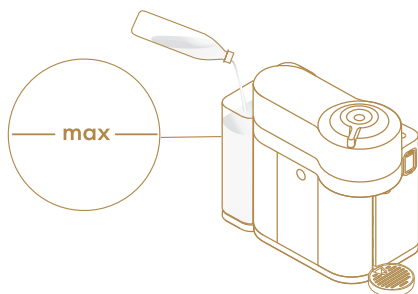

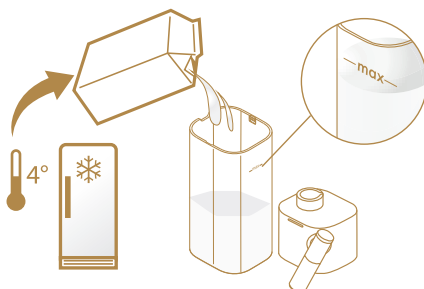

2. Fill the milk carafe up to the “MAX” level, do not overfill. Reassemble the milk carafe.





i **WARNING:** Plant-based beverages contain allergens (gluten, almond, soy) and should be handled carefully by people suffering from food allergies. The volume of froth depends on the nature of the beverage used, and its temperature.

i For a perfect milk froth, use fresh semi-skimmed, pasteurized cow milk at refrigerator temperature (about 4°C). It is recommended to clean the milk carafe after each use.

i **WARNING:** Do not use liquids other than cow milk and plant-based beverages.

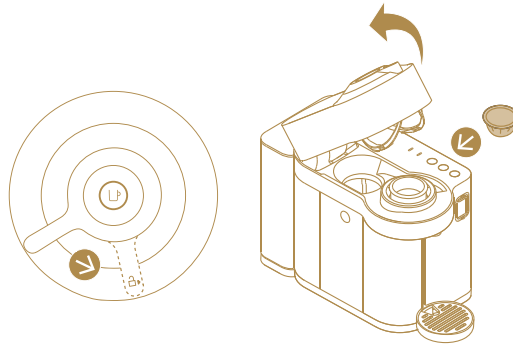
3. Turn the lever to the unlock position  and insert the capsule. Close the machine and then push the lever towards the lock position . The machine heats up for approximately 30 seconds (fading coffee button).



4. Turn the knob to the milk  position.

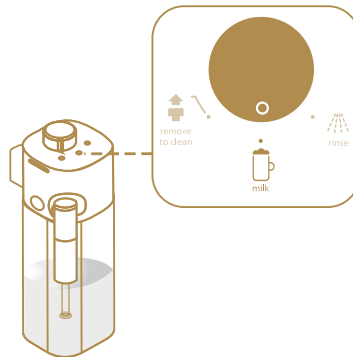



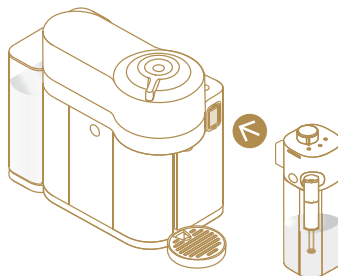

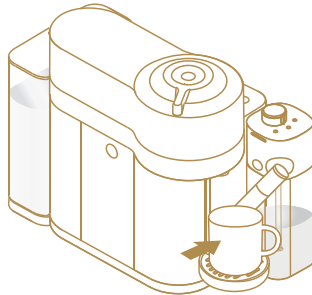

5. Open the steam connector door by sliding it down. Connect the milk ca-
rafe to the machine.



6. Place a cappuccino cup or a latte macchiato glass under the coffee outlet and adjust milk spout position by rotating it up to the center of the cup. Refer to section 12 for cup size selection according to recipe style and capsule selected.



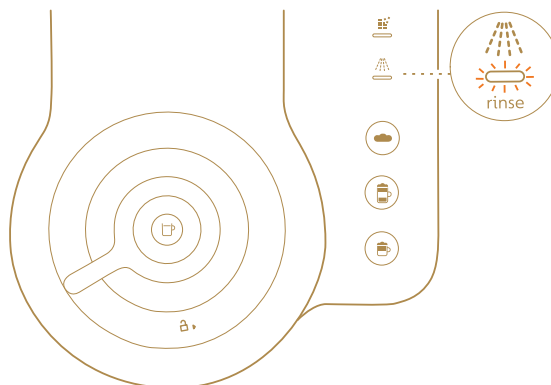

7. Wait until cappuccino button , latte macchiato button  and hot foam button  lights up.
8. Press the cappuccino  or latte macchiato button . The preparation starts after approx. 30 seconds (for cappuccino first coffee then milk, for latte macchiato first milk then coffee) and will stop automatically.
9. At the end of the preparation, the rinse  alert illuminates to indicate that a rinsing cycle of the milk carafe is required .

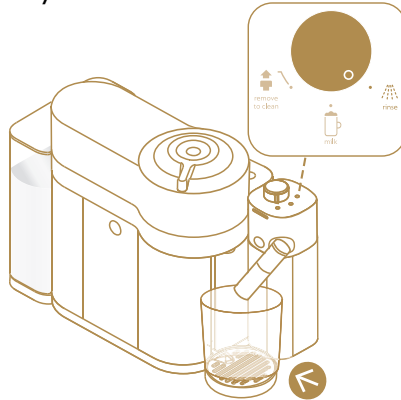

10. Place a container (minimum 200 ml) under the milk spout. Turn the knob to rinse  position. Milk system rinsing process starts and hot water combined with steam flows through the milk spout. The rinsing process stops automatically.



 **WARNING:** the rinsing system does not remove the allergens. Disassemble and clean the milk carafe before changing milks, preferably in the dishwasher. When a dishwasher is not available, wash by hand.

 After each milk or plant based beverage dispensing, the rinsing cycle of the carafe is recommended.

11. When the rinsing process is finished, the rinse alert turns off. Turn back the knob to milk position .

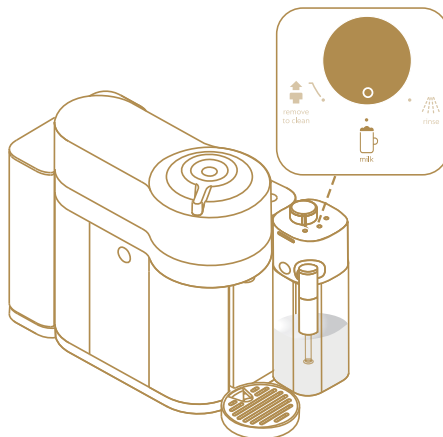

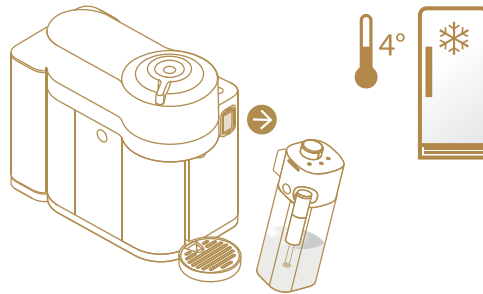

12. **If there is milk left in the milk carafe:** Disconnect the milk carafe from the machine and place it immediately in the refrigerator. Close the machine steam connector door by pulling it up.

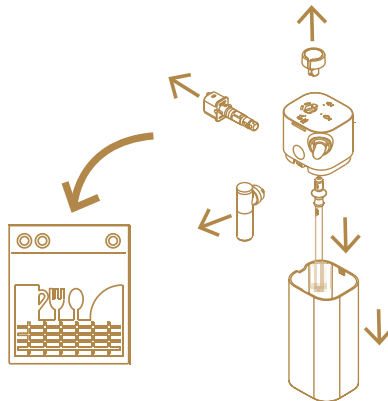

⚠ CAUTION: after rinsing, place the carafe in the refrigerator respecting the storing instructions on the milk package. If the milk carafe is kept outside the refrigerator for longer than 30 min, disassemble the milk carafe and clean all components (refer to "Cleaning the milk carafe" section).

13. If the milk carafe is empty or has been stored for more than 24 hours in the fridge; before refilling it, disassemble all six milk carafe components and clean them in the upper rack of your dishwasher. In case a dishwasher is not available, refer to section "Cleaning the milk carafe".









- i** NOTE: refer to section "Disassembling the milk carafe".
- i** NOTE: At the end of the preparation, turn the lever towards the unlock position  to open the machine and eject the capsule. Then, close the machine.

12 Milk recipes

ESPRESSO RANGE CAPSULES CAPPUCCINO:

A cappuccino is characterized by a coffee topped with a thick layer of milk froth on the top.



	CHOICE OF COFFEE		CHOICE OF CUP	
S		25 ml / 0.84 fl oz		Min 180 ml / 6 fl oz
M		40 ml / 1.35 fl oz		Min 270 ml / 9 fl oz
L		80 ml / 2.7 fl oz		Min 390 ml / 13 fl oz

TIPS:







The milk froth quality and aspect could be affected by the type, freshness and temperature of the milk (ideally stored at 4°C).

ESPRESSO RANGE CAPSULES

LATTE MACCHIATO:

A latte macchiato is a recipe in which coffee is poured over a glass of froth milk.



	CHOICE OF COFFEE		CHOICE OF CUP	
S		25 ml / 0.84 fl oz		Min 270 ml / 9 fl oz
M		40 ml / 1.35 fl oz		Min 390 ml / 13 fl oz
L		80 ml / 2.7 fl oz		Min 590 ml / 20 fl oz

TIPS:

The milk froth quality and aspect could be affected by the type, freshness and temperature of the milk (ideally stored at 4°C).

HOT FOAM:

Hot foam function to tailor your perfect milk beverage: by simply topping up your existing milk beverage with more foam, to have maximum flexibility to create your own milk beverage or just to enjoy a cup of hot milk foam.

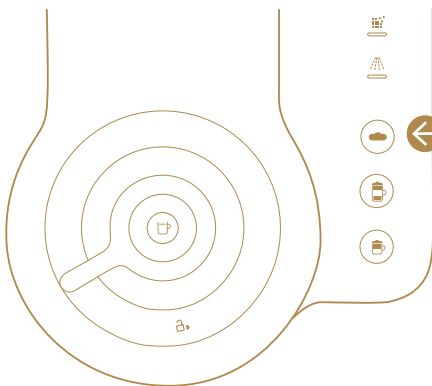

CHOICE OF CUP:

M  Min 270ml / 9fl oz

- A)** Press the hot foam button, when the default/programmed volume is reached the machine will automatically stop.

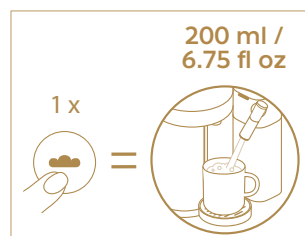

- B)** Press the hot foam button, when the desired quantity is reached stop the process by pressing the button again.



C) PROGRAMMING THE HOT FOAM VOLUME

1. Press and hold the hot foam button for three seconds, until it starts flashing.
2. Once the desired quantity is reached, press again hot foam button to save the new programmed volume. Volume can be reprogrammed from 80ml minimum to 200mL maximum.

Note: If you wish to come back to the default factory settings (200ml) see “Reset to factory settings” section.

Note:

- During the hot foam function it is possible to program a coffee. When the coffee button lights up, press it. When the milk beverage is completed, coffee will automatically start brewing. Make sure a capsule has been inserted.
- During the coffee brewing it is also possible program the hot foam function. When the hot foam button lights up, press it. When the coffee is completed, milk will automatically start to flow. Make sure the milk carafe has been inserted.

13 Energy saving

The machine can be turned “OFF” at any time (when not in use) by holding the coffee button for three seconds.

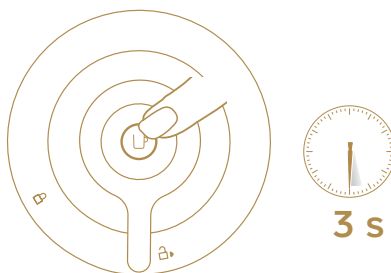

 Automatic “OFF” Mode: the machine will turn off automatically after 2 minutes of non-use.



14 Setting the coffee volume

1. Programming the coffee volume is specific to each capsule type: Espresso, Double Espresso, Gran Lungo, Mug or Carafe.
2. Open the machine, insert the capsule you want to program; close the machine; turn the lever towards the locked position . Light will blink while the machine is heating up. A steady light indicates the machine is ready.

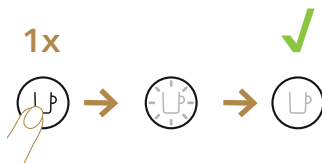

3. Then press and hold the button until desired volume is reached.



4. A new coffee volume is now stored for the capsule type used during the setting.



 Note: once a customer-specific volume is programmed by the user, every time that capsule type is inserted in the machine, the preparation will stop at the user-programmed cup size.

 Note: if you wish to return to the default parameters see “Reset to factory settings” section.

15 Reset to factory settings

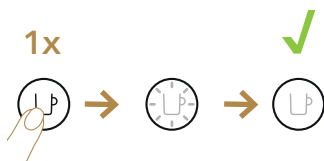
1. Plug the power cord.
2. Make sure that no accessory (milk carafe or descaling pipe) is connected to the milk carafe connector door. Turn on your machine.



3. Press and hold hot foam button  until both descale and rinse alerts blink (enter menu mode).
4. Press hot foam  button to enter in reset mode. If selection is not done within 15 sec., it exits automatically.
5. Only hot foam button will blink.
6. Press hot foam  button to reset to factory settings; all 3 milk recipe leds blink three times to confirm factory reset (within 15 seconds).
7. The machine is now programmed with factory settings and turns automatically in ready mode.



16 Turn on/off Bluetooth & Wi-Fi

1. Unplug the machine

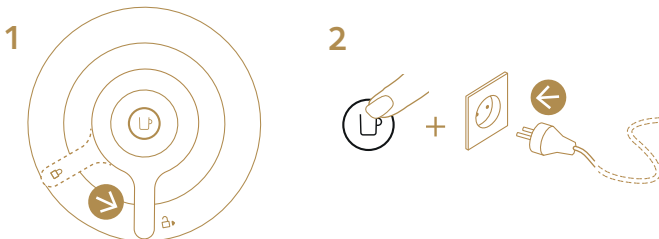

2. Make sure lever is in middle position. Press and hold the coffee button while plugging.



3. Selected operation:
 - TURN ON: the coffee button remains steady blue for a few seconds .
 - TURN OFF: the coffee button remains orange for a few seconds .
4. Machine returns to ready mode .

17

Emptying the system before a period of non-use, for frost protection or before a repair

1. Plug the power cord.
2. Make sure that no accessory (milk carafe or descaling pipe) is connected to the milk carafe connector door.
3. Empty the water tank and put it back.

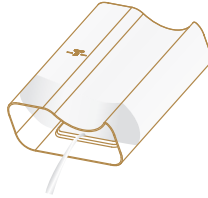

4. Open the machine head to eject the capsule.

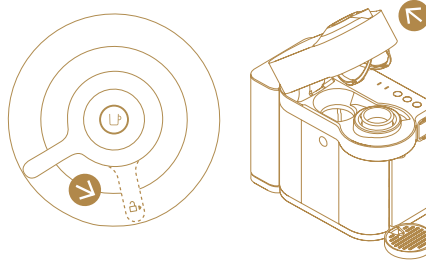

5. Empty capsule container, the drip tray and the cup support.

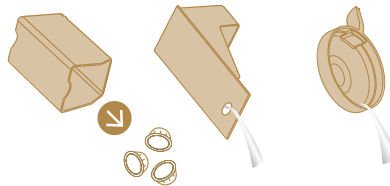



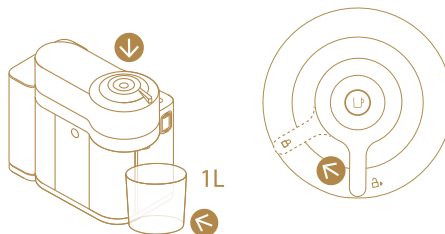

6. Close the head and turn lever left until lock position  and place a container (1L) under the coffee outlet.



7. Light will blink while the machine is heating up. Steady light indicates the machine is ready.



8. Press and hold hot foam button  until both rinse and descale alerts blink at the same time (menu mode entry)
9. Press hot foam  and latte macchiato  simultaneously to enter emptying mode. If selection is not done within 15 sec., it exits automatically.
10. Hot foam button blinks.
11. Press hot foam  button to start the emptying process (within 15 seconds).
12. When the process is finished, machine switches off.

⚠ CAUTION: Small quantities of steam may escape from the machine as it evacuates the remaining liquids.

18 After a long period of non-use

1. Rinse the water tank before filling with fresh potable water up to the maximum level.

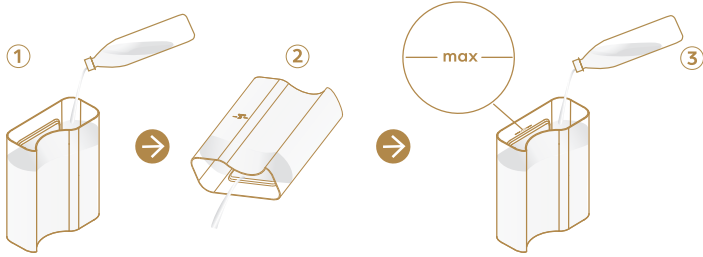

2. Put the water tank back in its position. Plug the power cord and place a container under the coffee outlet.

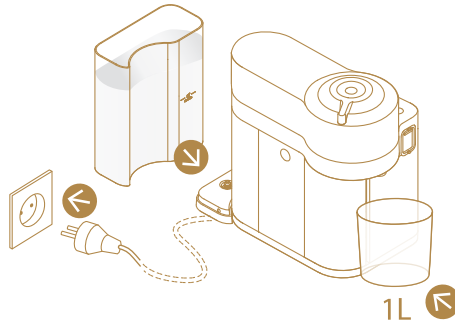

3. Turn on your machine.

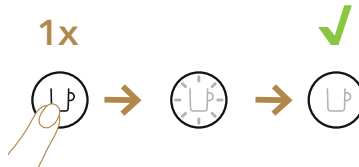

4. Press the coffee button three times within 2 seconds.



5. The machine will start rinsing. The cleaning procedure will run automatically for 5 minutes.
6. Disassemble the milk carafe and clean all six components in the top rack of your dishwasher. In case a dishwasher is not available, refer to "Cleaning the milk carafe" section.

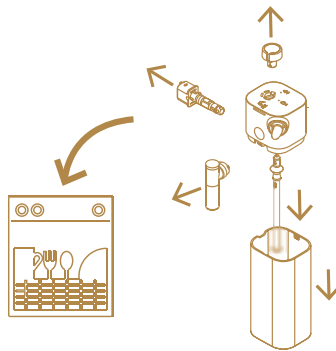

7. Then reassemble all six dried components and re-attach the milk carafe to the machine (refer to "Assembling / Disassembling the milk carafe" section).
8. Your machine is now ready to use.

i NOTE: water may accumulate inside the machine's head during cleaning. If this happens please dry visible parts with a clean dry cloth.

19 Cleaning cycle

The machine has a predefined cleaning procedure that can be launched at user discretion.

1. Rinse and clean the water tank and the lid before filling it with fresh potable water up to the “max” level. Put the water tank in place.

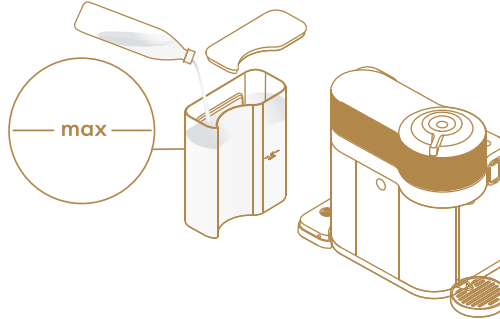

2. Take out the cup support and clean it. Wash with hot water and mild un-scented detergent.

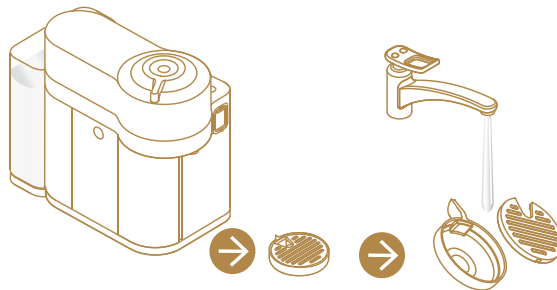

3. Place a container of at least 1 L under the coffee outlet.

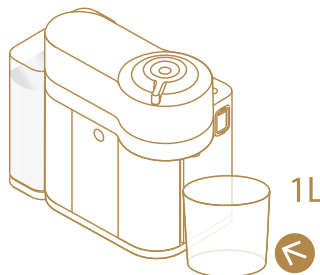

4. Open the machine and let the used capsule be ejected. Empty and rinse the capsule container and the drip tray.

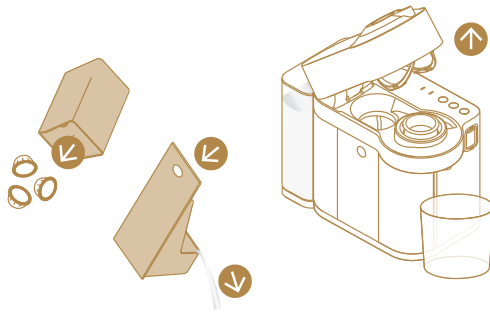

5. Close the head and turn lever left toward lock position  .

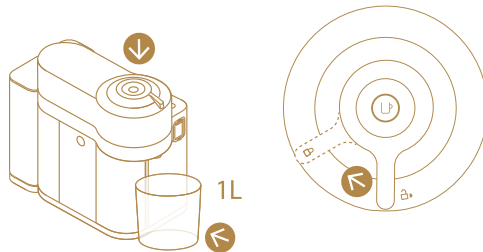

 Please make sure no capsule is present in the machine before running the cleaning cycle.

6. Light will blink while the machine is heating up. Steady light indicates the machine is ready.



7. Press the coffee button three times within 2 seconds.







8. The machine will start rinsing. The cleaning procedure will run automatically for 5 minutes.
9. The procedure can be stopped at any time by pushing the coffee button and turns automatically in ready mode.

⚠ CAUTION: do not use any strong or abrasive cleaning agent or solvent cleaner. Do not put in a dishwasher. Never immerse the appliance or part of it in water. Wipe the coffee outlet regularly with a clean damp cloth. Always use clean cloths to clean the machine.

i NOTE: water may accumulate inside the machine's head during cleaning. If this happens please dry visible parts with a clean dry cloth.

20 Descaling

 Descaling alert		
 descale	Blinks orange	Your machine must be descaled.
 descale	Fast blinking orange	Only few recipes before getting your machine blocked. Proceed immediately to descaling.
 descale	Steady light	Your machine is blocked to prevent any damages. Descal now.

To ensure the proper functioning of your machine over its lifetime, making your coffee experience as perfect as it was the first day, follow the process below:

1. When the descaling alert  starts to blink, it is time to descale your machine. The descaling time is approximately 20 minutes.

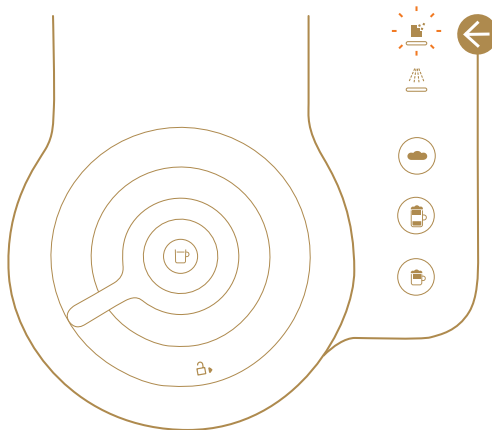

2. Open the machine and let the capsule be ejected.

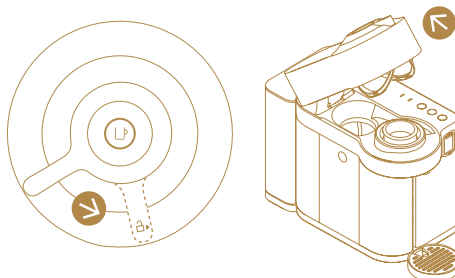

3. Close the head and turn the lever toward lock position  .
4. Empty the drip tray, used capsule container, cup support. Fill the water tank with two units of Nespresso descaling agent. Add water up to the “descale” mark on the water tank (~ 1000 ml / 1l / 33.81 fl oz).

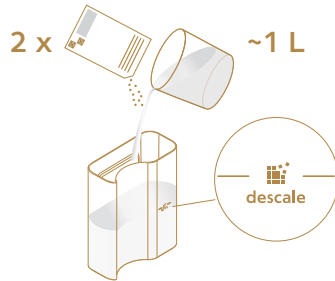

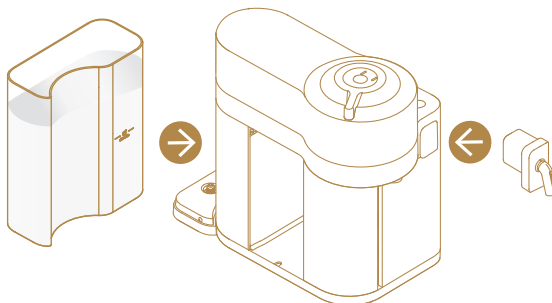
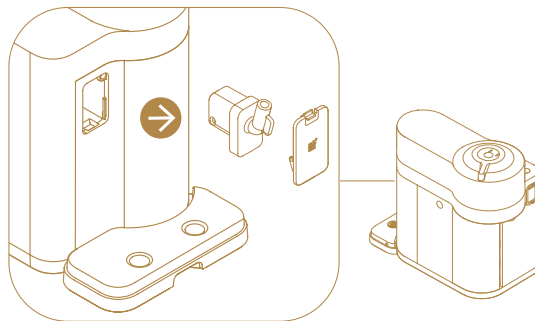

5. Take out the descaling pipe located at the back of the machine and plug it into the milk carafe connector. Put the water tank back on the machine.



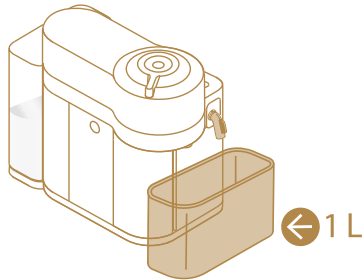

- The machine automatically enters in descaling mode. The “descal” alert blinks orange during the entire descaling process. The cappuccino button  lights up.
- Place a container with a minimum of 1L capacity under the coffee and descaling pipe nozzle.

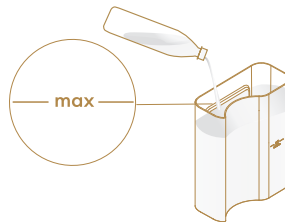

- Press cappuccino button . The descaling product flows alternately through the coffee outlet, descaling pipe, and drip tray. When the descaling cycle is finished (the water tank runs empty), the latte macchiato button  lights up.
- Empty the drip tray, used capsule container, cup support and container. Rinse and fill water tank up to “Max” level with fresh and potable water. Empty the 1L container and put it back under both outlets.



- Press the latte macchiato button . The rinsing cycle continues through the coffee outlet, descaling pipe and drip tray until the water tank is empty.
- Once the rinsing process is finished, the machine goes back to ready mode. Remove the descaling pipe and store it. Empty the drip tray and used capsules container. Fill the water tank with fresh potable water.

 **NOTE:** water may accumulate inside the machine’s head during cleaning. If this happens dry visible parts with a clean cloth.



i NOTE: Always respect descaling agent and water volumes in the tank to ensure completion of the cycles.











i The machine can still prepare several milk beverages before it is blocked preventively. The blockage prevents any damage to the machine and ensures its proper functioning over its lifetime.

In case the machine is blocked, please descale it. Please make sure the entire descaling procedure is completed. If it is not completed, the machine will remain blocked.

21 Troubleshooting



No light on the button.	<ul style="list-style-type: none"> • The machine has turned OFF automatically; push the button or “UNLOCK” the machine. • Check the mains, plug, voltage, and fuse.
No coffee, no water, no milk.	<ul style="list-style-type: none"> • Check that the water tank is filled. • Check that a fresh capsule is inserted in correct position, that the handle is properly locked and push the button to start. • Descale if necessary. • Open the machine head and let the capsule be ejected. Then perform a cleaning as per cleaning section. • Check if milk carafe is inserted and filled.
Coffee comes out very slowly.	<ul style="list-style-type: none"> • Flow speed depends on the coffee variety.
Coffee is not hot enough.	<ul style="list-style-type: none"> • Preheat cup with hot drinking water from the tap. • Descale if necessary.
Leakage or unusual coffee flow.	<ul style="list-style-type: none"> • Check that the water tank is well positioned. Empty the drip tray.
Machine turns to “OFF mode”.	<ul style="list-style-type: none"> • To save energy the machine will turn off after 2 minutes of non-use. • See section on “Energy Saving”.
Coffee grounds in the cup.	<ul style="list-style-type: none"> • Perform the cleaning procedure twice. • See “Cleaning cycle” section.
The machine doesn’t start and has lights steady on. If blinking, see next points.	<ul style="list-style-type: none"> • Check that handle is properly locked. • If you want to brew a Coffee or Espresso, check that a fresh capsule is inserted in correct position, that the handle is properly locked and push the button to start. • If you are cleaning, descaling or emptying the system, check that no capsule has been left inside, lock the machine and push the button to start one of these operations.

<p>The machine doesn't start and the lights blinks irregularly.</p>	<ul style="list-style-type: none"> • Fill the water tank and push button to start. • Check that handle is properly locked.
<p>Lights blink while machine is running.</p>	<ul style="list-style-type: none"> • If coffee or milk is flowing normally, this indicates the machine is working properly. • If only water is flowing, the machine is executing a user request for either cleaning, descaling or emptying the system. Refer to the corresponding section in this user manual.
<p>Lights blink and machine is not running.</p>	<ul style="list-style-type: none"> • It will take some time before the coffee flow comes out (due to code reading and pre-wetting the coffee). • Check that a fresh capsule is inserted in correct position, that the handle is properly locked and push the button to start. • Fill the water tank and push button to start. • Turn the machine to "OFF mode" by pushing the coffee button for 3 seconds and then push it again to turn the machine ON. Now wait approximately 20 minutes to allow the machine to cool down after extensive use.
<p>Lights blink irregularly. Machine is not running.</p>	<ul style="list-style-type: none"> • During regular Coffee/Esspresso preparation: 1) Unlock the handle and open the machine head to check that a fresh undamaged capsule is inserted in the correct position. 2) Check that the handle is in "LOCKED" position. 3) Check that the water tank is filled. • During Descaling, Emptying and Cleaning: 1) Check that capsule is ejected. 2) Check that the handle is in "LOCKED" position. • During Programming Volume: 1) Check if a capsule has been well inserted. 2) Please refer to the corresponding chapter. • If problem persists: <ul style="list-style-type: none"> • 1. Unlock the handle and open machine head. • 2. Replace capsule (if needed). • 3. Disconnect powercord from the outlet and plug the machine back into outlet after 10 seconds. • 4. Close the head and press the button to turn ON and press again to start brewing. If problem persists, call Nespresso.
<p>Descaling alert blinks or is fixed orange.</p>	<ul style="list-style-type: none"> • Machine triggers descaling alert according to your beverage consumption. Descale the machine. Refer to section "Descaling" according to your beverage consumption.
<p>Rinse alert blinks orange.</p>	<ul style="list-style-type: none"> • A rinsing cycle of the milk carafe is required, refer to section "Milk Preparation & Daily rinsing".
<p>I cannot enter the Menu Mode (Reset to factory settings/ Emptying the system before a period of non-use/Water hardness setting).</p>	<ul style="list-style-type: none"> • Be sure to remove the milk carafe from the connector door. • Be sure that the descaling pipe is not connected to the connector door. • Press and hold hot foam button  until descale and rinse alerts blink.
<p>Turn off the machine.</p>	<ul style="list-style-type: none"> • Hold the coffee button  for three seconds. See "Energy Saving" section.

<p>The brewed quantity is not enough.</p>	<ul style="list-style-type: none"> • Check that the water tank is filled. • Check if milk carafe is filled. • See section “Setting the coffee volume”.
<p>Lever cannot be closed completely.</p>	<ul style="list-style-type: none"> • Empty capsule container. Make sure that no capsule is blocked inside the capsule container.
<p>Quality of the milk froth is down-graded</p>	<ul style="list-style-type: none"> • Use semi-skimmed cow milk at refrigerator temperature (about 4° C). • Milk action knob is on remove to clean  position. Turn it to milk  position. • Rinse after each milk preparation and ensure the air inlet of the milk action knob is clean. See section («Cleaning the milk carafe»). • Descale the machine (refer to section «Descaling»). • Do not use either frozen milk or hot milk in the carafe. • Ensure that all the components of the milk carafe are well assembled. Refer to the section «Assembling the milk carafe».
<p>Milk carafe cannot be dismantled.</p>	<ul style="list-style-type: none"> • Press the button on the side of the milk carafe to remove the milk carafe lid. • Refer to section «Assembling / Disassembling of Milk carafe”.
<p>Milk carafe is inserted but the milk buttons are not enabled.</p>	<ul style="list-style-type: none"> • The milk action knob is on rinse  position. Turn it to milk  position. Wait for the coffee side to complete the heat up. • Make sure it is properly inserted.
<p>When Hot foam , Latte macchiato  and Cappuccino  buttons are blinking alternatively.</p>	<ul style="list-style-type: none"> • Machine overheat, wait until machine cools down.
<p>When Hot foam , Latte macchiato  and Cappuccino  buttons are blinking together.</p>	<ul style="list-style-type: none"> • Water tank is empty. • Fill the tank.

22

Specifications

	220-240 V, 50-60 Hz, 1300-1500 W USA, CA: 120 V, 60 Hz, 1500 W
Frequency	2.402 - 2.480 GHz
RF Output power (EIRP)	4 dBm Max (Bluetooth), 20 dBm Max (WIFI)
Standby	0.50 W/h (230V/50 Hz, EN 60661)
	6.3 kg
	1.6 L
(WxDxH)	190 x 407 x 315 mm (with cup support and milk carafe)

23

Disposal and environmental protection

This appliance complies with the EU Directive 2012/19/EC. Packaging materials and appliance contain recyclable materials. Your appliance contains valuable materials that can be recovered or can be recycled. Separation of the remaining waste materials into different types facilitates the recycling of valuable raw materials. Leave the appliance at a collection point. You can obtain information on disposal from your local authorities. To know more about **Nespresso** sustainability strategy, go to www.nespresso.com/positive

→ INSTRUCTIONS ARE ALSO AVAILABLE ON
WWW.NESPRESSO.COM



www.nespresso.com

57132C8437_00_0523