



VERTUO POP



NESPRESSO

CLICK AND CHOOSE YOUR LANGUAGE

EN

CN

KR

HK

TW

TH

BR

ES

HE

CLICK AND CHOOSE YOUR LANGUAGE

EN



SAFETY



OVERVIEW



CONNECTIVITY



FIRST STEPS



COFFEE PREPARATION



ADAPT YOUR COFFEE VOLUMES



CLEANING



DESCALING



EMPTYING THE SYSTEM



RESET TO FACTORY SETTINGS



BLINKING SUMMARY



TROUBLESHOOTING



SPECIFICATIONS

SAFETY

CAUTION: Before operating your coffee machine, please refer to the [safety instructions leaflet](#) to avoid possible harm and damage.

DISPOSAL AND ENVIRONMENTAL PROTECTION

This appliance complies with the EU Directive 2012/19/EC. Packaging materials and appliance contain recyclable materials. Your appliance contains valuable materials that can be recovered or can be recycled. Separation of the remaining waste materials into different types facilitates the recycling of valuable raw materials. Leave the appliance at a collection point. You can obtain information on disposal from your local authorities.

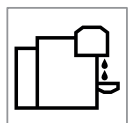

OVERVIEW

MACHINE OVERVIEW

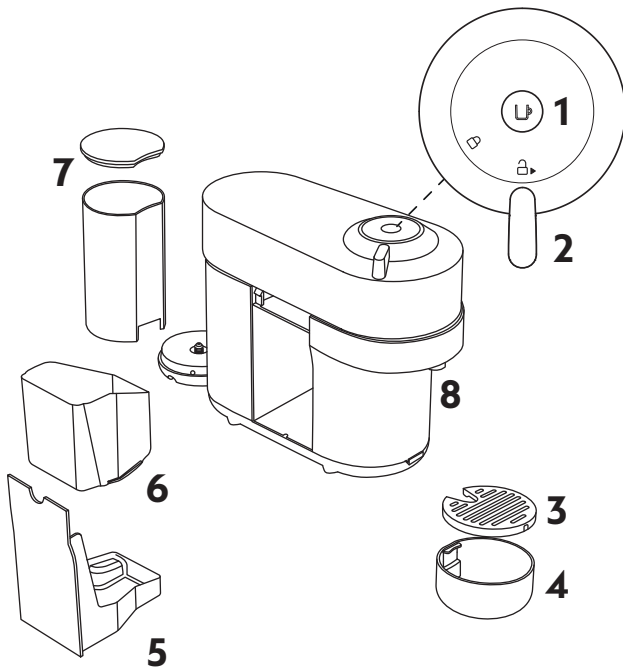

- 1 ON/OFF and Coffee Button
- 2 Locking/Unlocking Lever
- 3 Drip Grid
- 4 Adjustable Cup Support
- 5 Drip Tray
- 6 Container for used Capsules
- 7 Water Tank and Lid
- 8 Coffee Outlet

PACKAGING CONTENT



- 1 Coffee Machine
- 2 **Nespresso** Capsules Box
- 3 **Nespresso** Welcome Material
- 4 Safety Instructions
- 5 Quick Start Guide
- 6 Warranty

i Unboxing: When unpacking the machine, remove the plastic film. Some dust may be present due to recycled materials being used within the packaging. This is not dangerous, simply clean with a soft tissue.

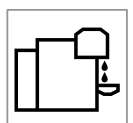



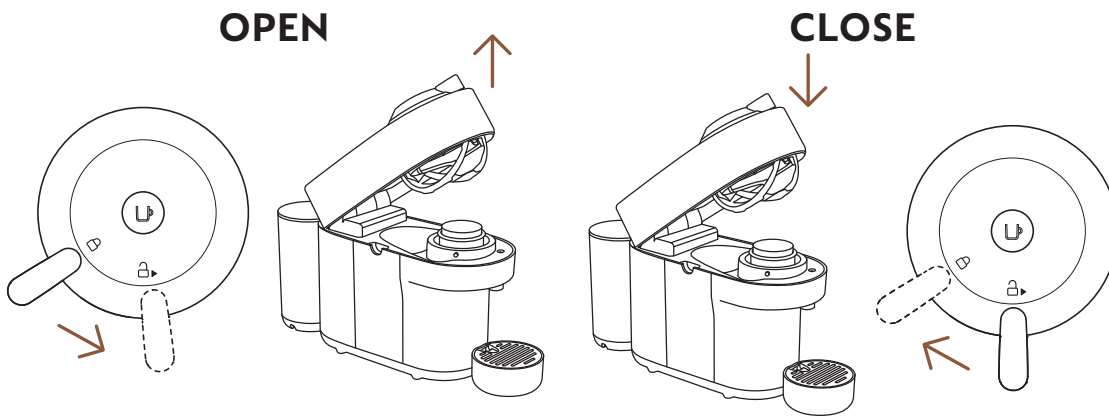

OPEN / CLOSE



CAUTION: for correct machine use, please do not open the machine head while the coffee is brewing, wait until the machine has stopped and the coffee button is steady and white. If you want to stop the brewing earlier, please press the Coffee Button once and wait until the coffee button goes back to steady white.

THE VERTUO SYSTEM

CAPSULE COMPATIBILITY

			
S	M	L	XL
Espresso	Double Espresso	Mug	Alto, Cold Brew Style
(40 ml / 1.35 fl oz)	(80 ml / 2.7 fl oz)	(230 ml / 7.77 fl oz)	(355 ml / 12 fl oz)
	Gran Lungo		Carafe
	(150 ml / 5.07 fl oz)		(535 ml / 18.8 fl oz)

ACCESSORY COMPATIBILITY

						
Accessory compatibility	Espresso	Double Espresso	Gran Lungo	Mug (S)	Mug (M)	Reveal Glass

		
Incompatible accessories	Mug (L)	Carafe

Discover our full collection of accessories on www.nespresso.com

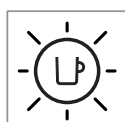
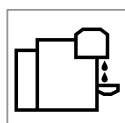
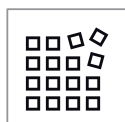
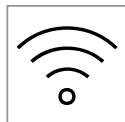

ON/OFF

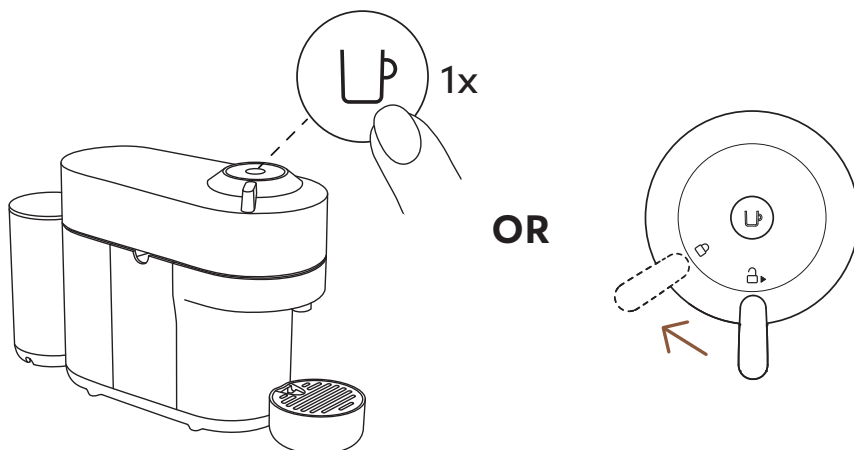

ON

Once the machine is plugged in, turn it on by pressing the Coffee Button once or by closing the lever into the lock position (whilst the head is closed).

i The light will blink for approximately 30 seconds while the machine is heating up. Once the light is steady, the machine is ready to be used.

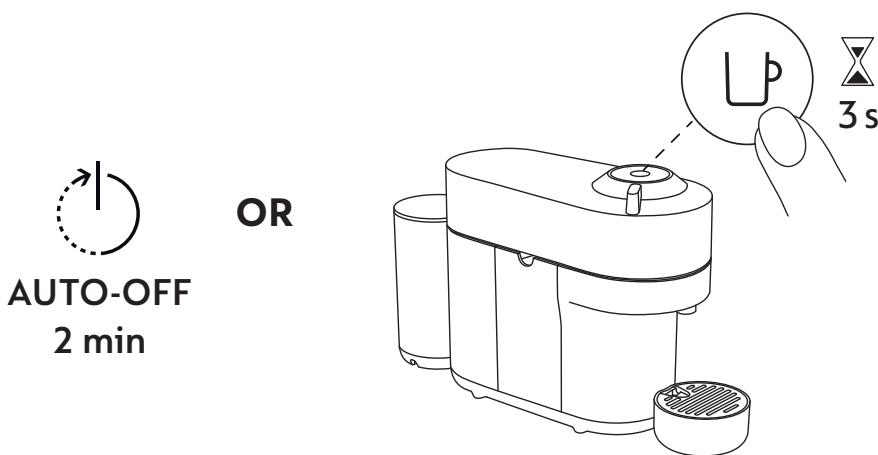

OFF

To save energy, the machine will turn off automatically after 2 minutes of non-use.

i The machine can be turned “OFF” manually at any time (when not in use) by pressing and holding the Coffee Button for 3 seconds.

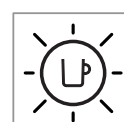
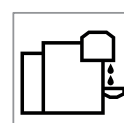
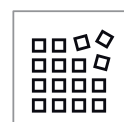
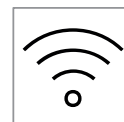

CONNECTIVITY

WHY SHOULD YOU PAIR YOUR VERTUO POP MACHINE?

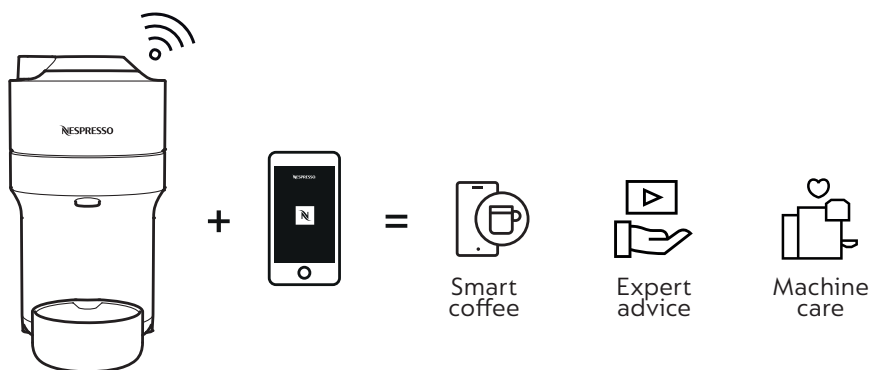

BENEFITS OF CONNECTING YOUR VERTUO POP MACHINE

- **Smart coffee:** Always stay one step ahead and get the latest coffee innovations from **Nespresso** by keeping your machine up to date
- **Expert advice:** Get support and simple tutorial videos to accompany your coffee journey via your smartphone
- **Machine care:** Receive instant notification on how and when to service your machine with an easy-step guide on descaling, rinsing, cleaning, etc.

HOW TO CONNECT YOUR VERTUO POP MACHINE?

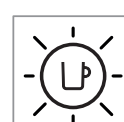
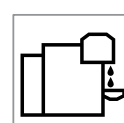
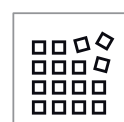



1 Download or update the **Nespresso** App. Launch the **Nespresso** App on your smartphone or your tablet. Press the machine icon at the top right of your screen.

NOTE: for optimal performance and a seamless experience, we recommend connecting your machine to a Wi-Fi router rather than using a smartphone hotspot.

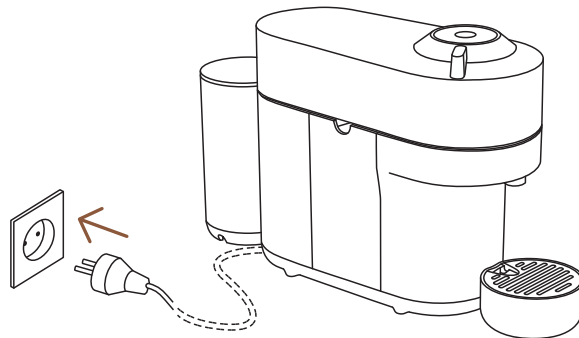

2 Plug in the power cord and switch on.



3 Follow the instructions via the **Nespresso** App.

CAUTION: First read the safety precautions to avoid risks of fatal electrical shock and fire. Please ensure ground continuity when plugging the machine into the power outlet.

* AppStore® is a trademark of Apple Inc., registered in the U.S. and other countries.
 ** Google Play and the Google Play logo are trademarks of Google LLC.

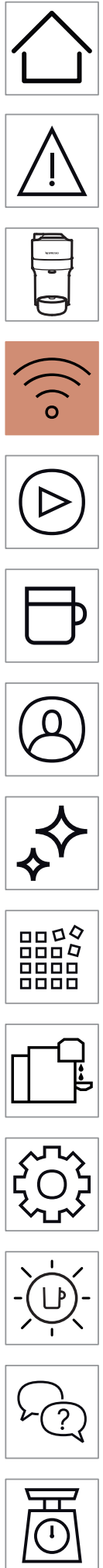

DISABLING MACHINE BLUETOOTH AND WI-FI

The machine comes with a connectivity module, enabled by default. It gives access to additional features, enhancing your coffee experience. To disable the connectivity module, follow these steps:

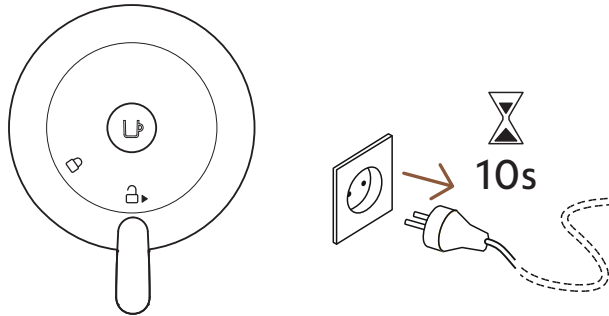

- 1 With the machine closed and the lever in **unlocked** position, unplug the machine for at least 10 seconds.

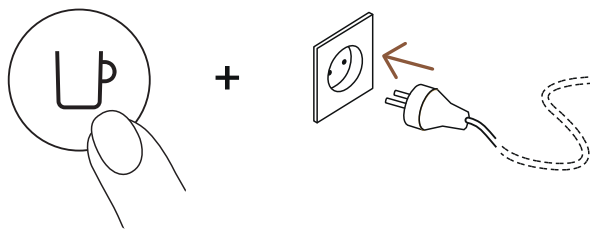

- 2 Press and hold the button whilst plugging in the machine. The button will blink orange to confirm that the connectivity module has now been disabled.

- i** Follow the same steps to set the connectivity module back on again. The button will blink white to confirm that the module has been reactivated.



FIRST STEPS

FIRST RINSING

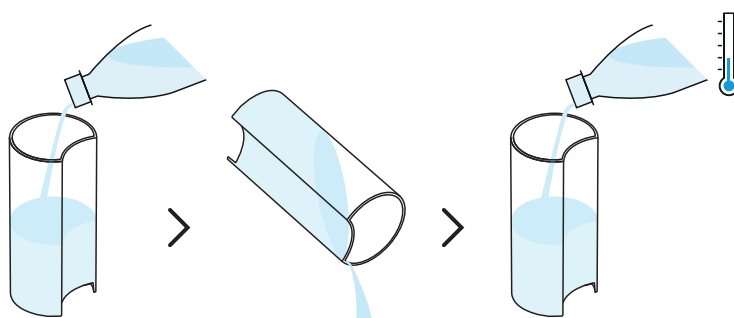

- 1** Rinse and clean the water tank and lid before filling it with fresh drinking water.

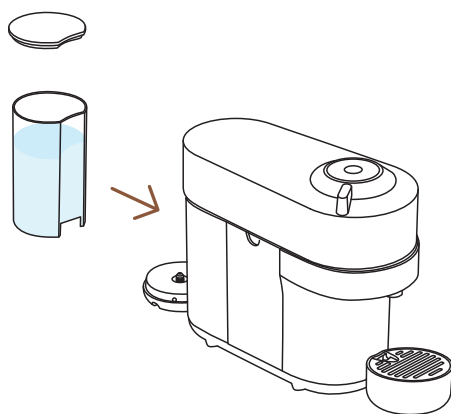

- 2** Put the lid on the water tank and put the water tank in place. Make sure it is properly attached.

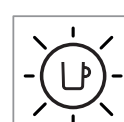
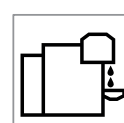
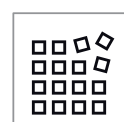
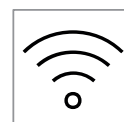

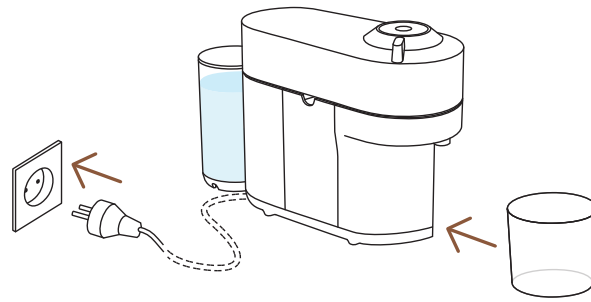

- 3** Plug the power cord in, remove the cup support and place an empty container (of at least 1 L / 34 fl oz) under the coffee outlet.

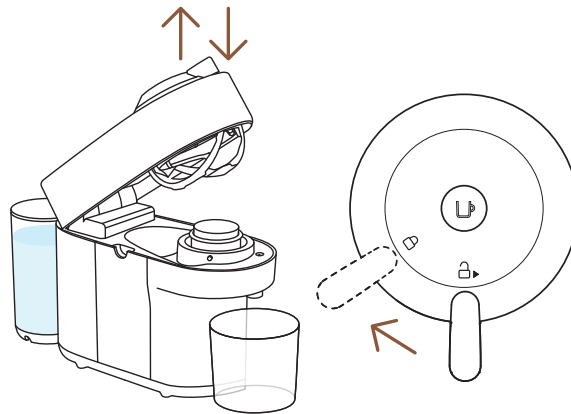

- 4** Open and close the machine. Ensure the lever is in lock position.

- i** The light will blink while the machine is heating up. It will take approximately 30 seconds. When the light becomes steady the machine is ready. Make sure that no capsule is inserted.

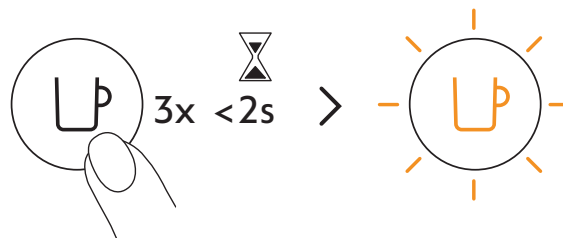

- 5** Press the button 3 times within 2 seconds to start rinsing. Let the rinsing procedure complete automatically. When the light becomes steady white, the cycle is complete.

- i** It should take less than 2 minutes before the rinsing process begins and water starts to flow. This procedure may take up to 7 minutes.

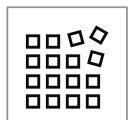

COFFEE PREPARATION

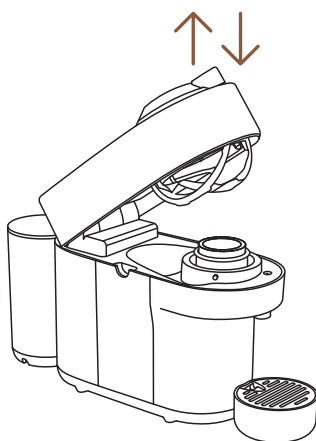

1 Open and close the machine.

i The coffee button light will blink while the machine is heating up. When the light becomes steady, the machine is ready to use.

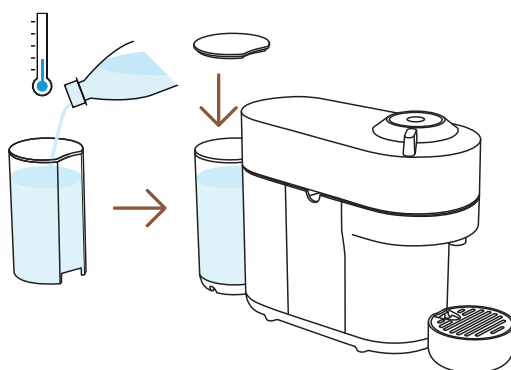

2 Fill the water tank with fresh drinking water and put it back in position.

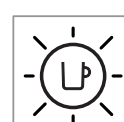
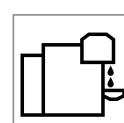
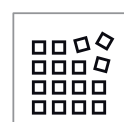
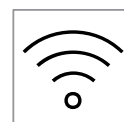

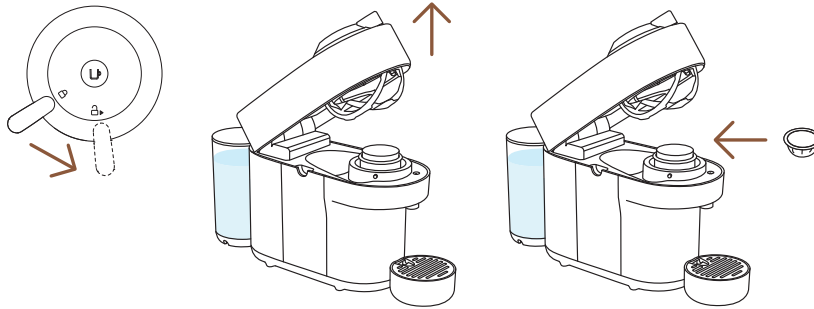

- 3** Unlock and open the machine head completely and insert a Vertuo capsule with the dome shape facing down.

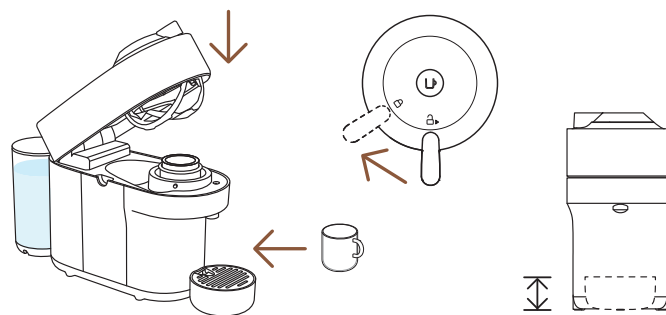

- 4** Close the machine head and lock by turning the lever left into the lock position and place a cup on the cup support. The cup support can be adjusted to accommodate your cup size.

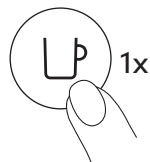

- 5** Start brewing by pressing the button once.

CAUTION: for correct machine use, please do not open the machine head while the coffee is brewing, wait until the machine has stopped and the coffee button is steady and white. If you want to stop the brewing earlier, please press the Coffee Button once and wait until the coffee button goes back to steady white.

- i** Due to the barcode reading, coffee pre-wetting and infusion time, it will take a moment before the coffee begins to flow. The machine will automatically recognize the inserted capsule and select the coffee preparation parameters and cup length defined by **Nespresso** coffee experts to extract the coffee blends at it's best.

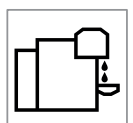

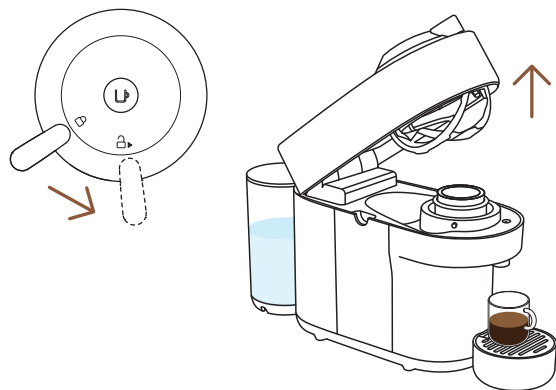

6 When the coffee stops brewing, open the machine head by turning the lever right towards the unlock position to automatically eject the capsule and enjoy your coffee.



7 Don't forget to recycle your **Nespresso** capsules.*

* THIS IS **NESPRESSO**. THIS IS RECYCLABLE. For more information about recycling your **Nespresso** capsules, visit www.nespresso.com

DISCOVER OUR COFFEE CREATIONS MODE



With this machine, **Nespresso** offers you a specific function to concentrate your coffee extractions to create your own recipes.

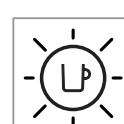
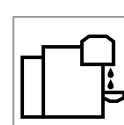
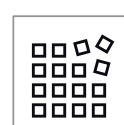
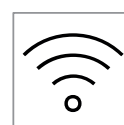

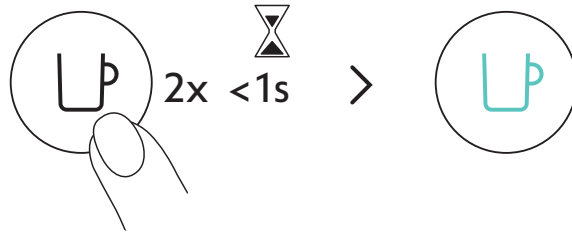

With your machine turned on and a capsule inserted and the head closed and locked, double click the coffee button. It will blink turquoise and your coffee brew will be concentrated, optimizing the coffee taste in recipes with add-ons (milk, cream, over ice...). For Incomparable Coffee Experience.

40 ml / 1.35 fl oz	80 ml / 2.7 fl oz	150 ml / 5.07 fl oz	230 ml / 7.77 fl oz	355 ml / 12 fl oz	535 ml / 18.8 fl oz
✓	✓	✓	✓	✗	✗
25 ml / 0.85 fl oz	40 ml / 1.35 fl oz	40 ml / 1.35 fl oz	80 ml / 2.7 fl oz		

To fully enjoy the benefits, we recommend brewing our Coffee+ range using only the official cup sizes. For the best in-cup results, we do not recommend brewing our XL (Alto Ambrato, Alto Onice), Cold Brew Style & Carafe Pour Over Style with this mode.

NOTE: An update of your machine via the **Nespresso** App may be necessary to enable this mode.



Discover how to upgrade your machine with our Aeroccino range on www.nespresso.com

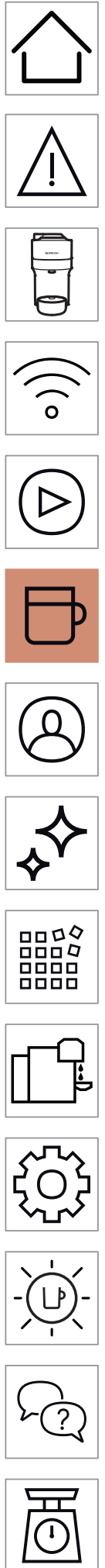

ADAPT YOUR COFFEE VOLUMES

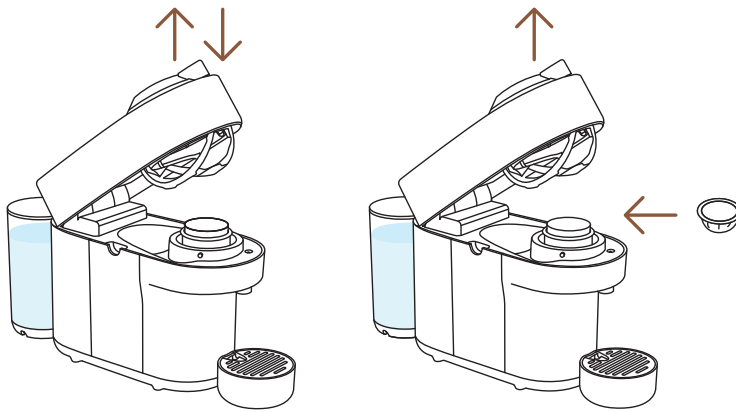

- 1** Open the machine and insert the capsule you want to program.

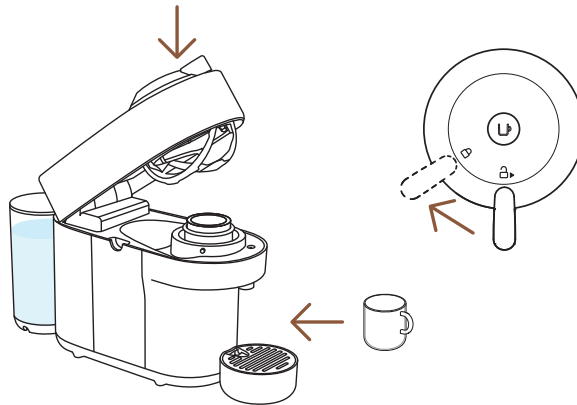

- 2** Close the machine head, turn the lever left towards the lock position and place a cup on the cup support.

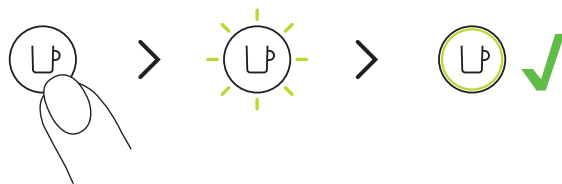

- 3** Press and hold the button, letting go a few seconds before the desired volume is reached. The new water volume is now programmed for the capsule type used during the setting.

- i** The programming is specific to each capsule type. Cup sizes may be programmed from 20 ml / 0.7 fl oz to 535 ml / 18 fl oz.



CAUTION: for correct machine use, please do not open the machine head while the coffee is brewing, wait until the machine has stopped and the coffee button is steady and white. If you want to stop the brewing earlier, please press the Coffee Button once and wait until the coffee button goes back to steady white.

NOTE: Once a customer-specific volume is programmed by the user, every time that capsule type is inserted in the machine, the preparation will stop at the user-programmed cup size. If you wish to come back to the default parameters see the paragraph “Reset to factory settings”.

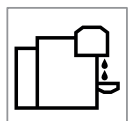
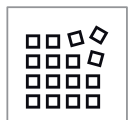

CLEANING

Clean your machine on a monthly basis, when you start having coffee residue inside the machine head or after a long period of non-use.

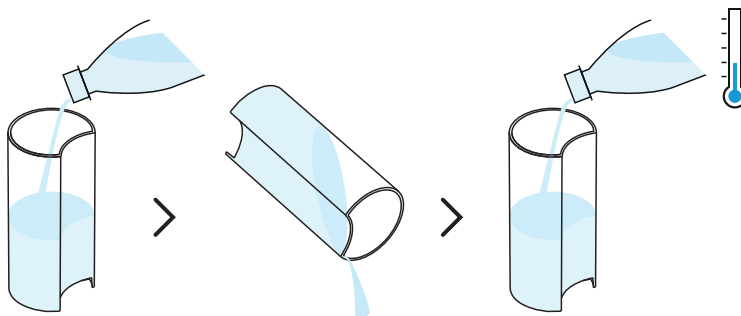

- 1** Rinse and clean the water tank and the lid before filling it with fresh drinking water.

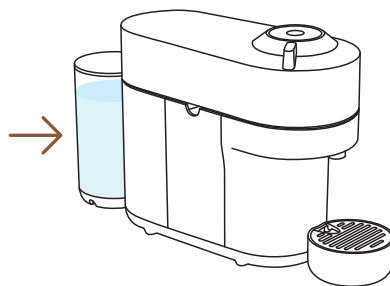

- 2** Put the water tank back in position on the machine.

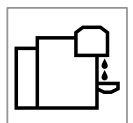

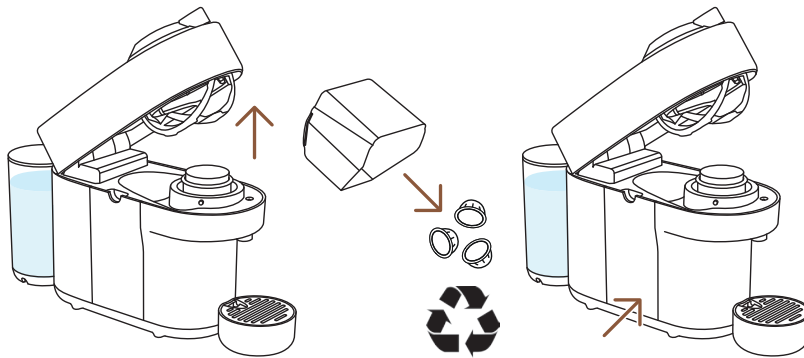

- 3** Unlock and open the machine and eject your used capsule*. Empty and rinse the capsule container and the drip tray and put them back in place.

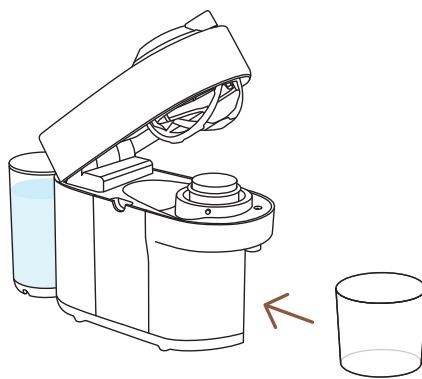

- 4** Remove the cup support and place an empty container (of at least 1 L / 34 fl oz) under the coffee outlet.

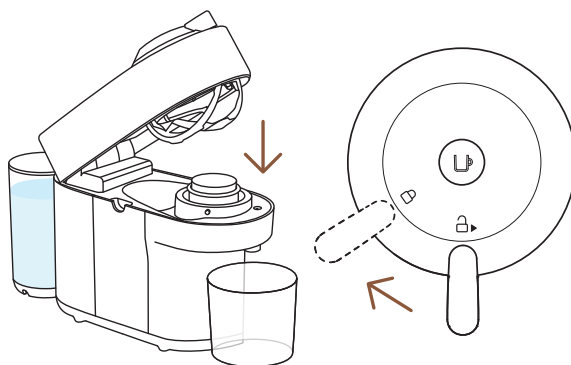

- 5** Close the machine head and turn the lever left towards lock position. Make sure no capsules are present in the machine before starting the cleaning procedure.

* THIS IS **NESPRESSO**. THIS IS RECYCLABLE. For more information about recycling your **Nespresso** capsules, visit www.nespresso.com



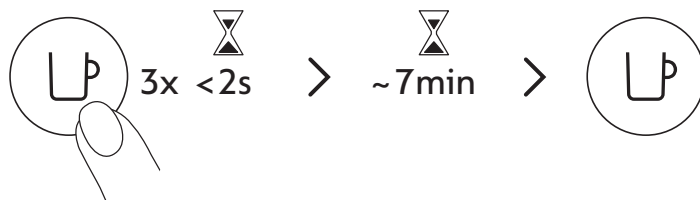

- 6** Press the button 3 times within 2 seconds to start rinsing. Let the cleaning procedure complete automatically.

- i** It should take less than 2 minutes before the cleaning process begins and water starts to flow. This operation may take up to 7 minutes and will stop automatically when the cycle is complete. The procedure can be stopped at any time by pressing the button.

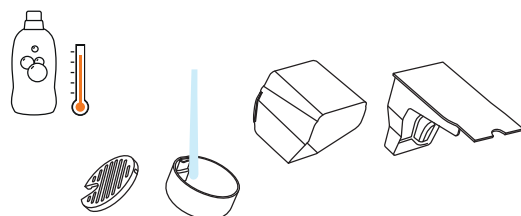

- 7** Wash the capsule container, the cup support and the drip tray with hot water and mild odourless detergent.

CAUTION: Do not use any strong or abrasive cleaning agent or solvent cleaner. Do not put the machine in a dishwasher. Never immerse the appliance or part of it in water.

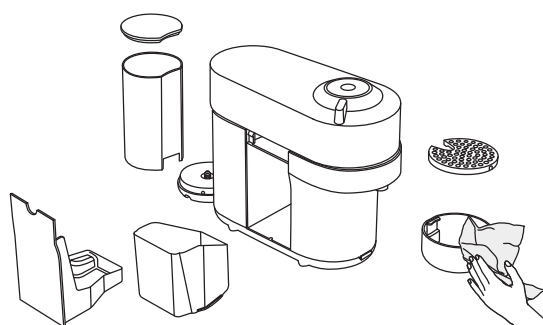

- 8** Dry the machine with a clean and fresh towel.

CAUTION: Clean the coffee outlet regularly with a clean damp cloth. Always use soft cloths to clean the machine.

NOTE: Water may accumulate inside the machine's head during cleaning. If this happens, please dry visible parts with a clean dry cloth.

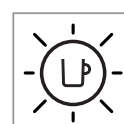
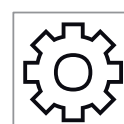
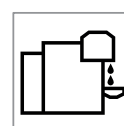
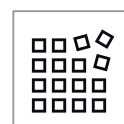
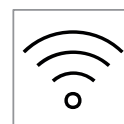

DESCALING

Descaling your machine will ensure that it functions properly throughout its lifetime and will make your coffee experience as incomparable as it was the first day. Your machine will indicate when descaling is needed by blinking orange 3 times before steady white.



i The descaling procedure takes ~20 minutes and **cannot be interrupted**.

NOTE: Please carefully read the descaling instructions before starting.

You will need:

- A descaling kit available on www.nespresso.com
- An empty container (of 1 L / 34 fl oz)

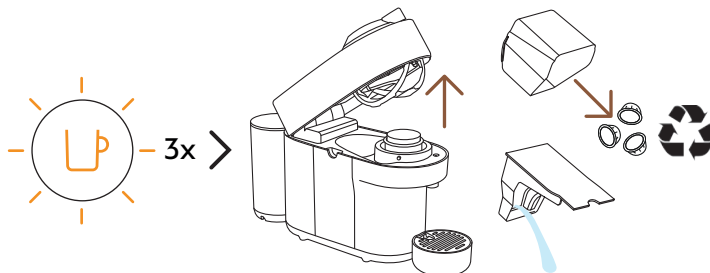

1 With the button blinking orange 3 times: Unlock and open the machine head to eject any used capsule*. Empty the capsule container and drip tray and put them back into position on the machine.

* THIS IS **NESPRESSO**. THIS IS RECYCLABLE. For more information about recycling your **Nespresso** capsules, visit www.nespresso.com

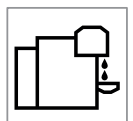
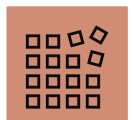

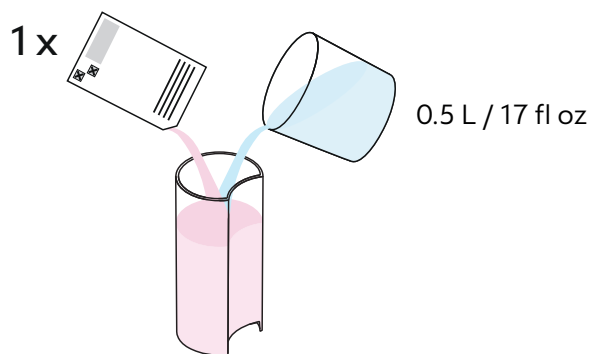

- 2** Fill the water tank with 0.5 L / 17 fl oz of water and add 1 unit of **Nespresso** descaling liquid.

CAUTION: Please note that the descaling solution can be harmful. Avoid contact with eyes, skin and surfaces.

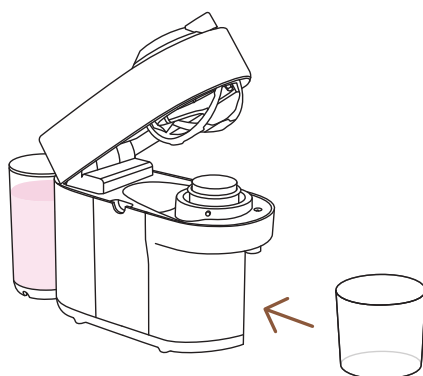

- 3** Remove the cup support and place an empty container (of at least 1 L / fl 34 oz) under the coffee outlet.

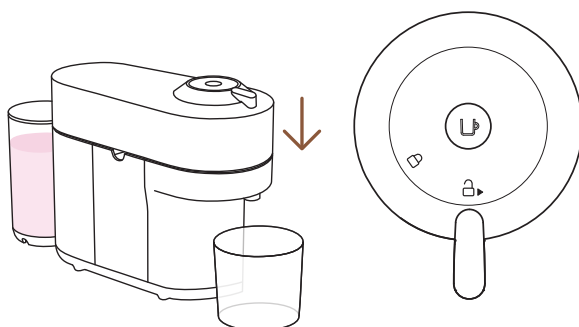

- 4** With the machine on, close the machine head and leave the lever in the unlock position.

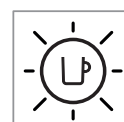
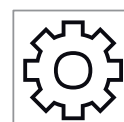
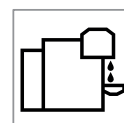
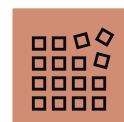
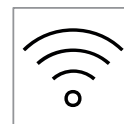

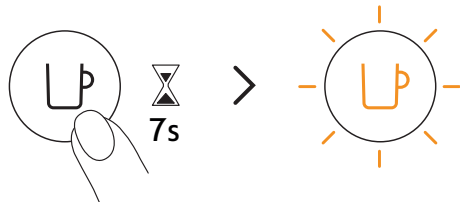

- 5** Hold the button for at least 7 seconds or until you see the light turn off. The button will start blinking orange rapidly.

CAUTION: You now have 45 seconds to enter the descaling mode, otherwise the machine will return to the brewing mode.

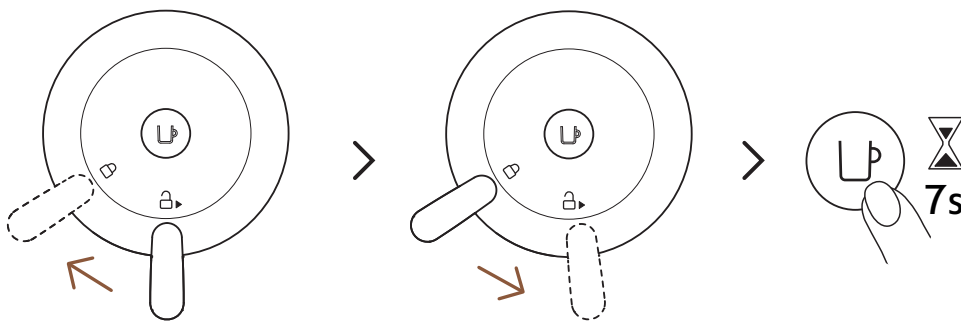

- 6** Lock the machine head by turning the lever left until the lock symbol and then unlock the lever by turning right to the unlock position. Press and hold the button again for approximately 7 seconds or until the light turns off. The button will start blinking orange rapidly.

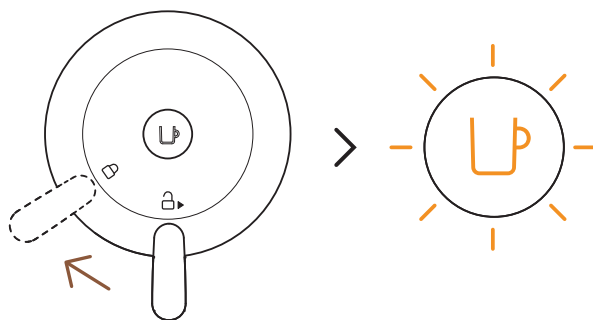

- 7** To enter the descaling mode, lock the machine by turning the lever left towards the lock position. The light should still be blinking orange quickly. This is an indication that you have entered descaling mode.

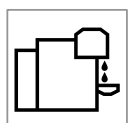
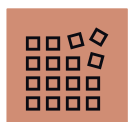

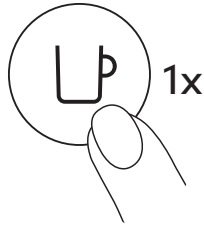

- 8** Press the coffee button once to begin the descaling process. The light will continuously blink orange throughout the process.

- i** The machine will stop automatically when the first phase of descaling is completed.

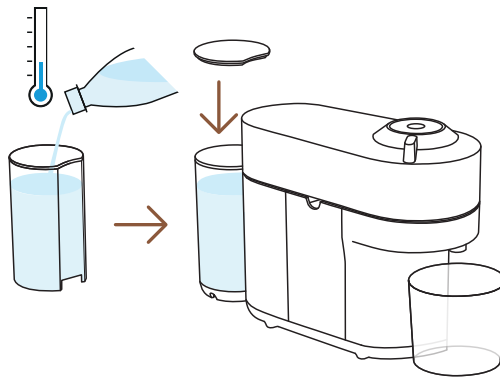

- 9** At the end of the descaling process, it is time to rinse the machine. Rinse the water tank and drip tray thoroughly. Fill the water tank with fresh drinking water and put it back in place. Empty the container and place it back under the coffee outlet.

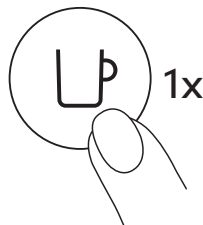

- 10** Press the button to rinse the machine. When the button stops blinking rapidly and becomes steady, the descaling procedure is completed.

- i** The machine will stop automatically when the procedure is completed.

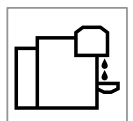

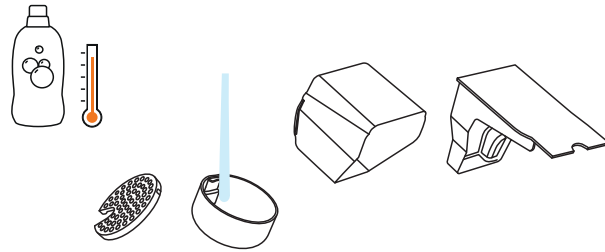

- 11** Wash the capsule container, the cup support and the drip tray with hot water and mild odourless detergent.

CAUTION: Do not use any strong or abrasive cleaning agent or solvent cleaner. Do not put the machine in a dishwasher. Never immerse the appliance or part of it in water.

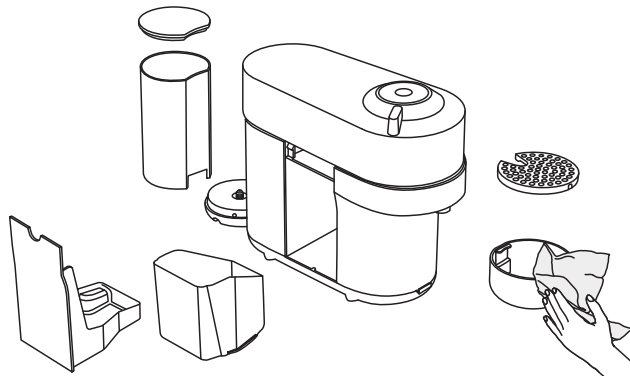

- 12** Dry the machine with a clean and fresh towel. Let the machine dry for 10 minutes before using it.

NOTE: Water may accumulate inside the machine's head during cleaning. If this happens, please dry visible parts with a clean dry cloth.

NOTE: the machine can only enter descaling mode after 30 or more coffees have been brewed.

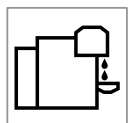

EMPTING THE SYSTEM

Emptying the system is a process that could be done before a period of non-use, for frost protection or prior to sending the machine for a repair.

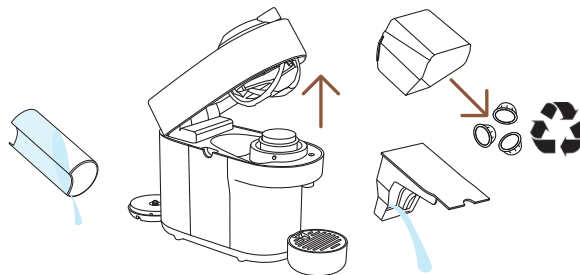

- 1** Empty the water tank, open the machine head, and let the used capsule be ejected. Empty the capsule container and the drip tray. Don't forget to recycle your **Nespresso** capsules.*

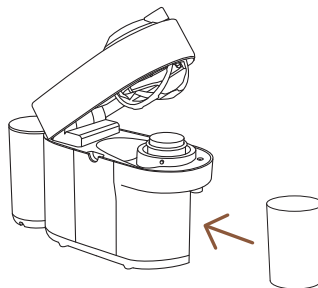

- 2** Place them back in position on the machine, remove the cup support and place an empty container (0.5 L / 17 fl oz) under the coffee outlet.

* THIS IS **NESPRESSO**. THIS IS RECYCLABLE. For more information about recycling your **Nespresso** capsules, visit www.nespresso.com

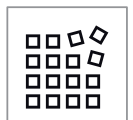

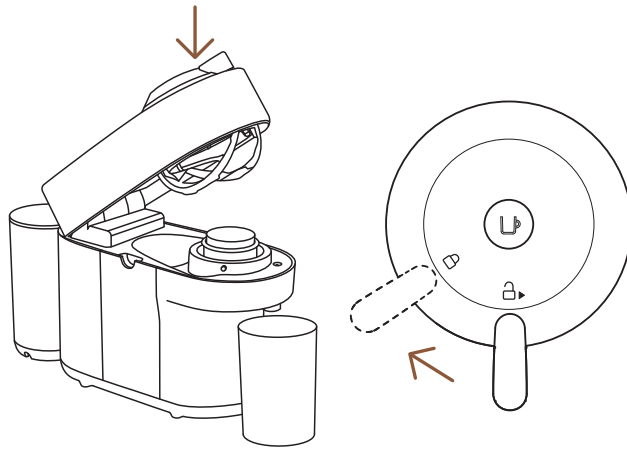

- 3** With the machine plugged in, open and close the machine head and turn the lever towards the lock position.

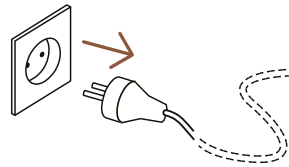

- 4** Unplug the machine.

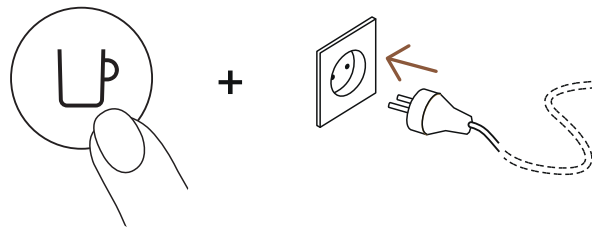

- 5** Press and hold the button while plugging in the machine.

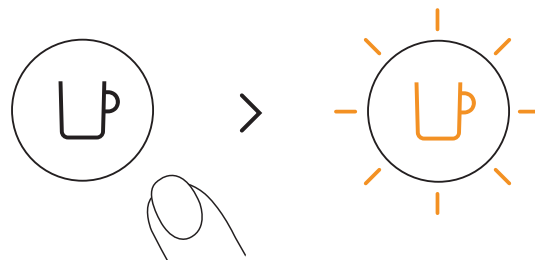

- 6** Release the button. It will blink orange and the emptying process will start.

- i** It will take approximatively 30 seconds for the machine to complete the emptying process. The machine turns off automatically when it is empty.



RESET TO FACTORY SETTINGS

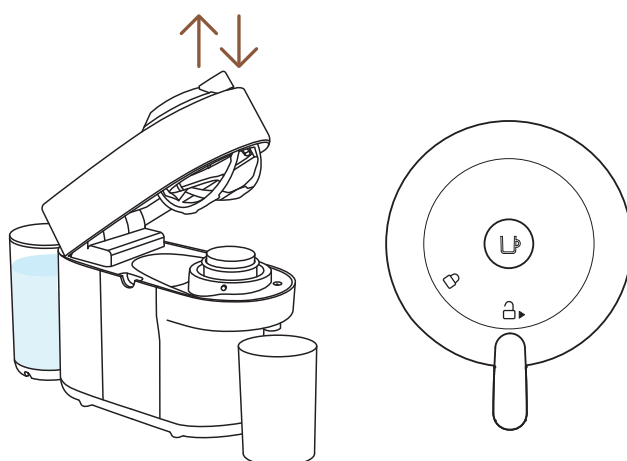

- 1 With the machine plugged in, open and then close the machine head before leaving the lever in the **unlock** position.

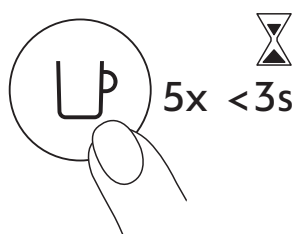

- 2 Press the button 5 times within 3 seconds. The machine is now programmed with the factory settings.

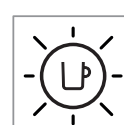
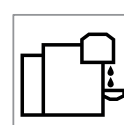
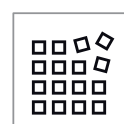
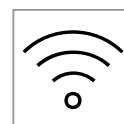

BLINKING SUMMARY

You want to learn more about the Vertuo Pop blinkings?
Please watch the following video:

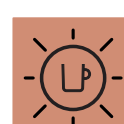
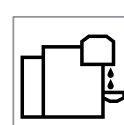
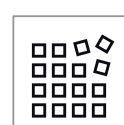
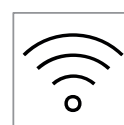

TROUBLESHOOTING

- No light on the button.**
- The machine has turned OFF automatically; press the button or “UNLOCK” the machine.
 - Check the mains, plug, voltage, and fuse.
- No coffee, no water.**
- Check that the water tank is filled.
 - Check that a fresh capsule is inserted in the correct position, that the lever is properly locked and press the button to start.
 - Descale if necessary.
 - Open the machine head and eject any used capsule that is in the machine. Then perform a clean as per the cleaning section.
- Coffee is not hot enough.**
- Preheat the cup with hot drinking water from the tap.
 - Descale if necessary.
- Leakage or unusual coffee flow.**
- Check that the water tank is well positioned.
 - Descale if necessary.
- Machine turns to “OFF mode”.**
- To save energy the machine will turn off after 2 minutes of non-use.
 - The machine can be turned “OFF” manually at any time (when not in use) by pressing and holding the button for 3 seconds.
- Coffee grounds in the cup.**
- Perform the cleaning procedure twice.
 - See paragraph on **“Cleaning”**.
- The machine doesn't start and has light steady on. If blinking, see next points.**
- Check that the lever is properly locked.
 - If you want to brew a Coffee or Espresso, check that a fresh capsule is inserted in the correct position, that the lever is properly locked and press the button to start.
 - If you are cleaning, descaling or emptying the system, check that no capsule is inserted then close, lock the machine and press the button to start one of these operations.
- The machine doesn't start and light blinks alternately; 1 blink and 1 pause.**
- Fill the water tank and press the button to start.
 - Check that the lever is properly locked.

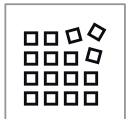

Light blinks while machine is running.

- If the coffee is flowing normally, this indicates the machine is working properly.
- If only water is flowing, the machine is executing a user request for either cleaning, descaling or emptying the system. Refer to the corresponding section in this user manual.
- Turn the machine to “OFF mode” by pressing the button for 3 seconds and then press it again to turn the machine ON. Now wait approximately 20 minutes to allow the machine to cool down after extensive use.



Light blinks and machine is not running.

- It will take some time before the coffee flow comes out (due to code reading and pre-wetting the coffee).
- Check that a fresh capsule is inserted in the correct position, that the lever is properly locked and press the button to start.
- Fill the water tank and press the button to start.
- Turn the machine to “OFF mode” by pressing the button for 3 seconds and then press it again to turn the machine ON. Now, wait approximately 20 minutes to allow the machine to cool down after extensive use.



Light blinks alternately 2 blinks and 1 pause continuously. Machine is not running.

- During regular Coffee/Esspresso preparation:
 - 1) Unlock the lever and open the machine head to check that a fresh undamaged capsule is inserted in the correct position.
 - 2) Check that the lever is in “LOCKED” position.
 - 3) Check that the water tank is filled.
- During Descaling, Emptying and Cleaning:
 - 1) Check that the capsule is ejected.
 - 2) Check that the lever is in “LOCKED” position.
- During Programming Volume:
 - 1) Check if a capsule has been well inserted.
 - 2) Please refer to the corresponding chapter **“Adapt your coffee volume”**.

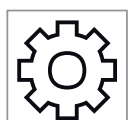

**Light alternately
blinking 3 times and
then steady on.**

- If the problem persists:
 - 1) Unlock the lever and open the machine head.
 - 2) Replace the capsule (if needed).
 - 3) Disconnect the power cord from the outlet and plug the machine back into the outlet after 10 seconds.
 - 4) Close the head and press the button to turn ON and press again to start brewing. If the problem persists, call **Nespresso**.
- Descaling needed: the machine can be used only a few times after the descaling alert appears before it becomes necessary.

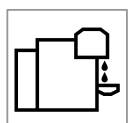

SPECIFICATIONS

Power	~220–240 V, 50–60 Hz, 1300–1500 W US, CA: 120 V, 60 Hz, 1500 W MX: 127 V~, 60 Hz, 1380 W
Frequency	2.402–2.480 GHz
RF output power (EIRP)	Bluetooth 4 dBm Max. e.i.r.p. and Wi-Fi <20 dMm max. e.i.r.p.
Standby	0.39 W/h
Power saving mode	Auto-off after 2 min
Heat-up time	30 seconds (head closed and locked)
Movable cup support for large recipes	Removable single position
Cable length from device dispatch	75 cm / 30 in
Dimensions (W x D x H)	13.6 x 42.6 x 25 cm / 5.3 x 16.7 x 9.8 in
Weight	3.5 kg / 7.72 lbs
Water tank capacity	600 ml / 20 fl oz
Capsule container capacity	8 espresso or 5 mug capsules

MACHINE CODES

Nespresso	Breville	Delonghi
GCV2, GDV2	BNV120, BNV150	ENV90
Krups	Magimix	
XN9201, XN9204, XN9205, XN9211	M800	

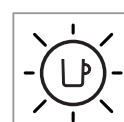
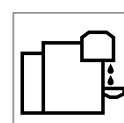
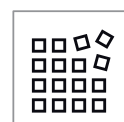
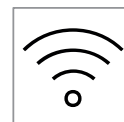

点击并选择你的语言

CN



安全须知



概览



网络连接



首次使用



咖啡制备



调节咖啡杯量



清洁



除垢



清空系统



恢复出厂设置



按键灯提示



故障排除



规格

安全须知

注意: 首次使用咖啡机前请仔细阅读安全须知, 以避免任何伤害和损坏。

处置和环境保护

本机器依从欧盟的法规EU Directive 2012/19/EC。包装材料和机器本身均包含一些可回收材料。您的咖啡机包含一些有价值的材料, 这些材料可以被回收再利用。分类剩余的材料以便于后续回收。把机器送到收集点。您可以通过本地的相关机构获得电器处理的信息。

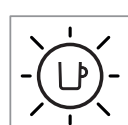
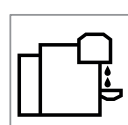
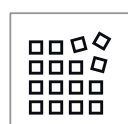
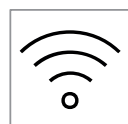

概览

机器概览

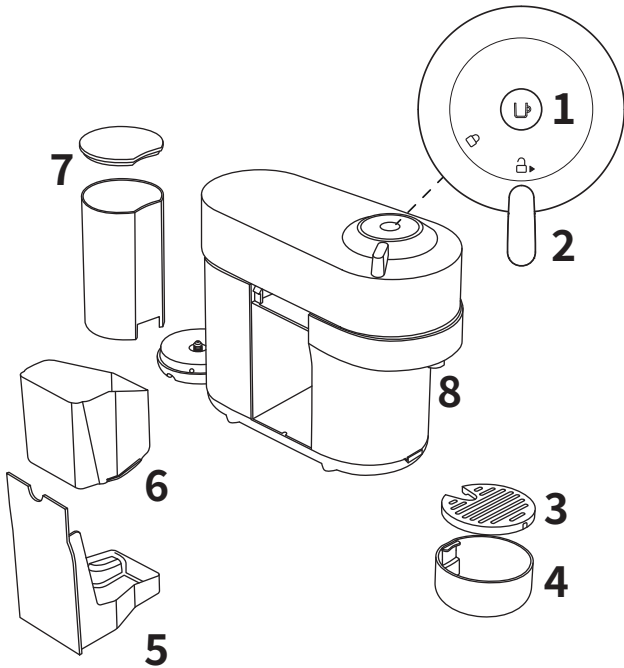

- 1 开/关与咖啡按键
- 2 锁定/解锁手柄
- 3 滴水隔栅
- 4 可调节杯托
- 5 滴水盘
- 6 废弃粉囊盒
- 7 水箱和盖子
- 8 咖啡出口

包装内容



- 1 咖啡机
- 2 Nespresso粉囊套装
- 3 Nespresso欢迎手册
- 4 安全指示
- 5 快速入门指南
- 6 保修

i 开箱: 由于包装中使用了回收材料, 因此可能会有一些灰尘出现在机器表面。这没有危险, 只需用软纸巾清洁即可。

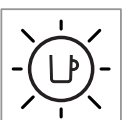
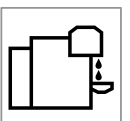
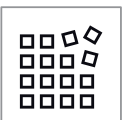
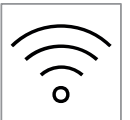

打开/关闭

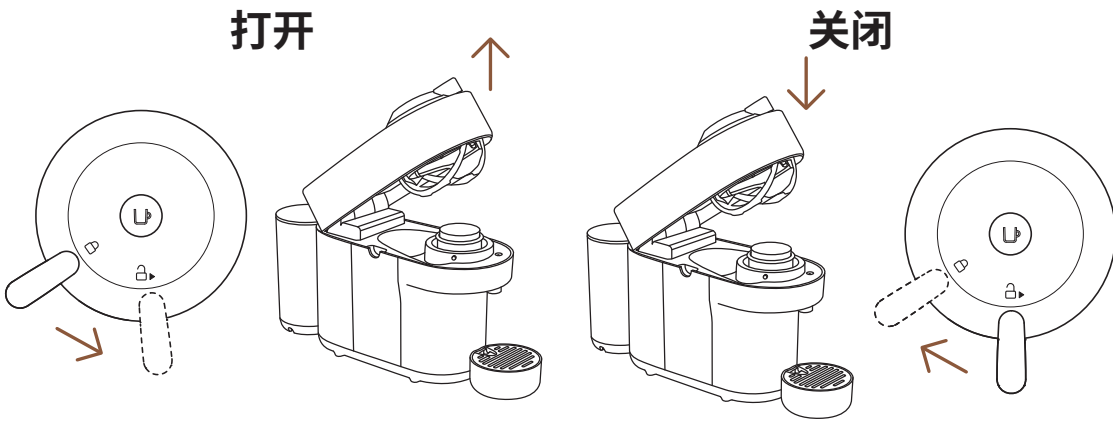

注意:为正确使用咖啡机, 请勿在机器运行时打开机头, 等待机器的按键变为白色后再打开。如果你想提前停止萃取, 请按下咖啡按键, 等待机器停止, 再打开机头。

VERTUO 系统

粉囊兼容性



配件兼容性



请访问 www.nespresso.com 了解我们的全套配件系列

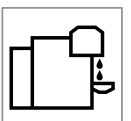
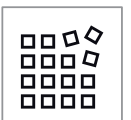

开/关

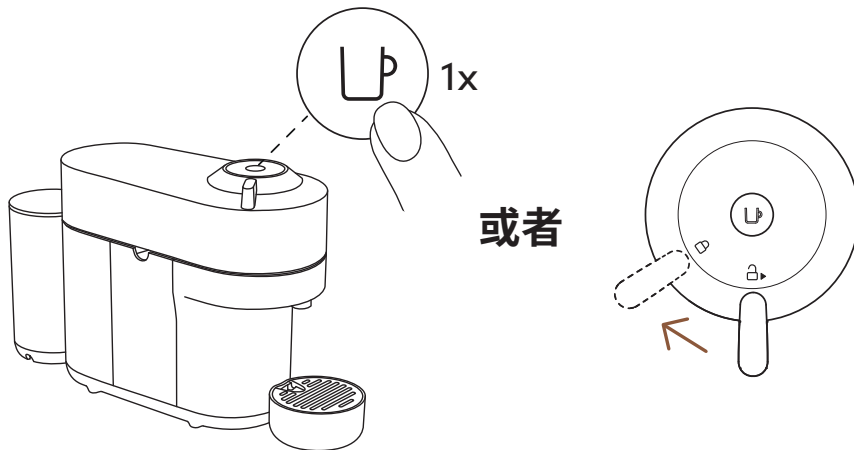

开

机器一旦插上电源, 按下按键一次或将手柄关闭在锁定位置 (头部关闭) 即可打开电源。

i 机器加热时, 指示灯将闪烁约30秒。一旦灯光稳定, 机器就可以使用了。

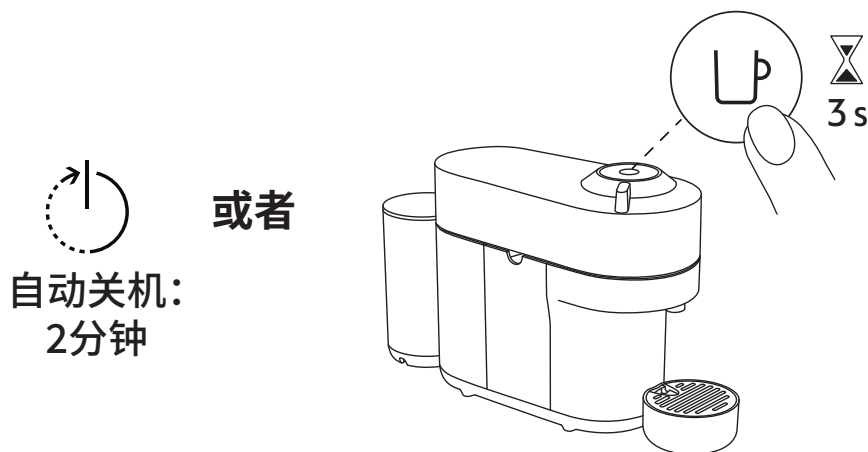

关

为节省能源, 机器在未使用2分钟后会关闭。

i 按住按键3秒钟, 机器可以随时手动“关闭”(不使用时)。

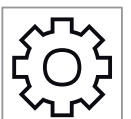
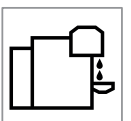
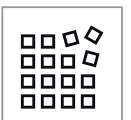

网络连接

为什么要对VERTUO POP机器配对？



连接VERTUO POP机器的好处？

- **智能咖啡:** 始终保持领先一步, 让你的机器保持最新状态, 了解Nespresso咖啡创新的最新信息
- **专业建议:** 通过智能手机获取支持和简单的教程视频, 伴随你的咖啡之旅
- **机器保养:** 通过收到即时通知来获得如何以及何时服务你的机器关于除垢, 冲洗, 清洁等简单的指引步骤。

如何连接你的VERTUO POP机器？

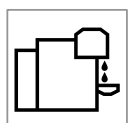
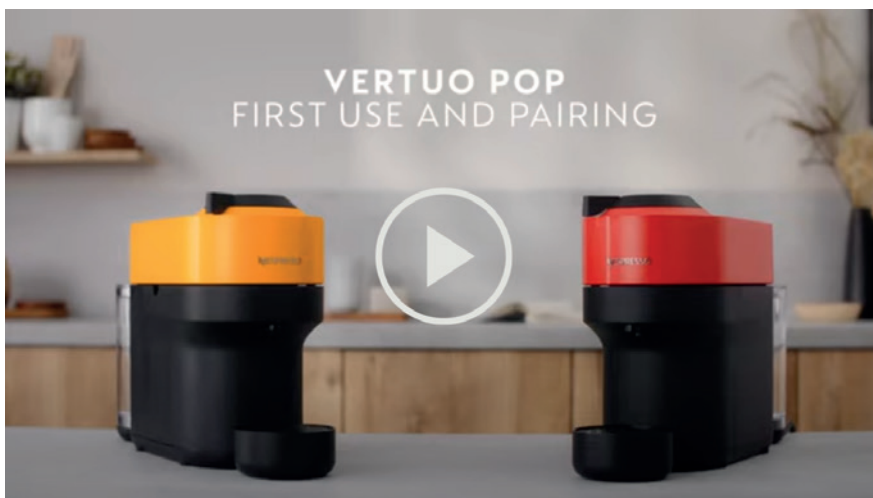

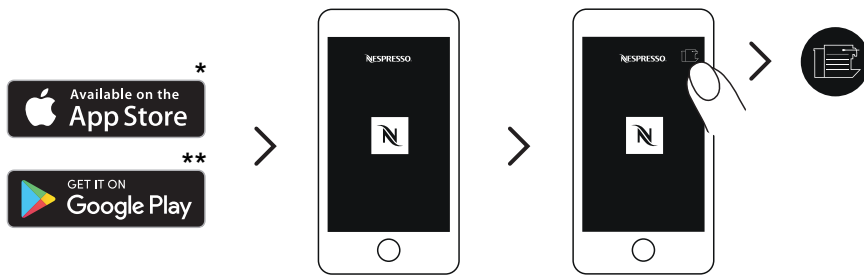

1 下载或更新**Nespresso**应用程序。在智能手机或平板电脑上启动**Nespresso**应用程序。按下屏幕右上角的机器图标。

注意:为了获得最佳性能和顺利的使用,我们建议你将机器连接到Wi-Fi路由器,而不是智能手机热点。

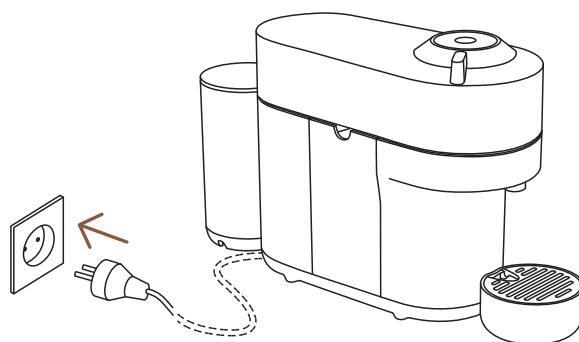

2 插上电源线。



3 通过**Nespresso**应用程序按照说明操作。

注意:首先阅读安全注意事项,以避免致命的触电和火灾风险。将机器插入电源插座时,请确保接地连接。

* App Store®是Apple Inc.在美国及其他国家和地区注册的商标。
 ** Google Play 和 Google Play 标志是 Google LLC. 的商标。

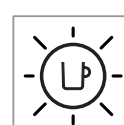
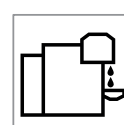
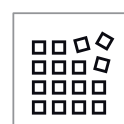

禁用机器蓝牙和WIFI

该机器附带一个连接模块,默认情况下已启用。它提供了额外的功能,增强了你的咖啡体验。

要禁用连接模块,请执行以下步骤:

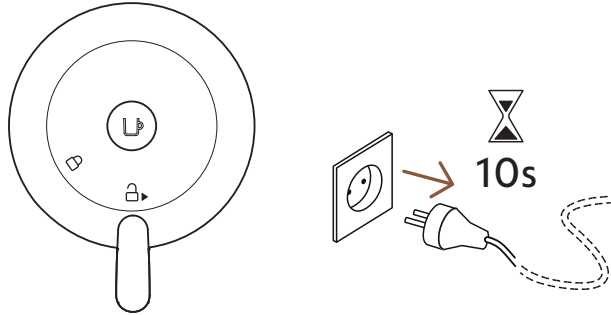

- 1** 在机器关闭且手柄处于解锁位置的情况下,拔下机器插头至少10秒钟。

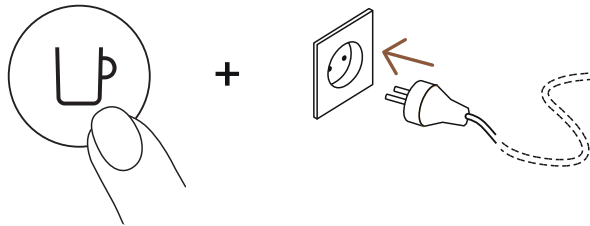

- 2** 插入电源时按住按键
该按键将闪烁橙色,以确认连接模块现已禁用。

- i** 按照相同的步骤重新打开连接模块。
该按键将闪烁白色,以确认模块已重新激活。

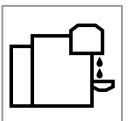
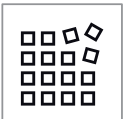

首次使用

首次冲洗

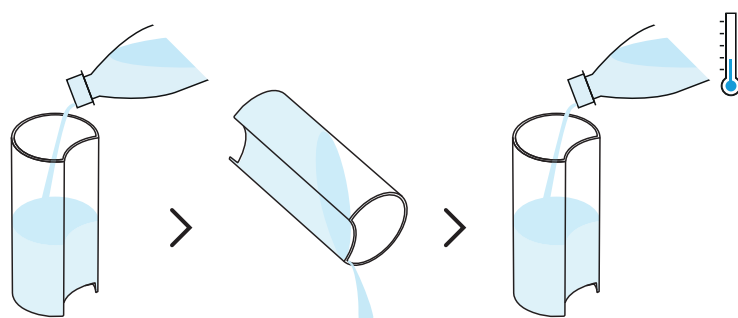
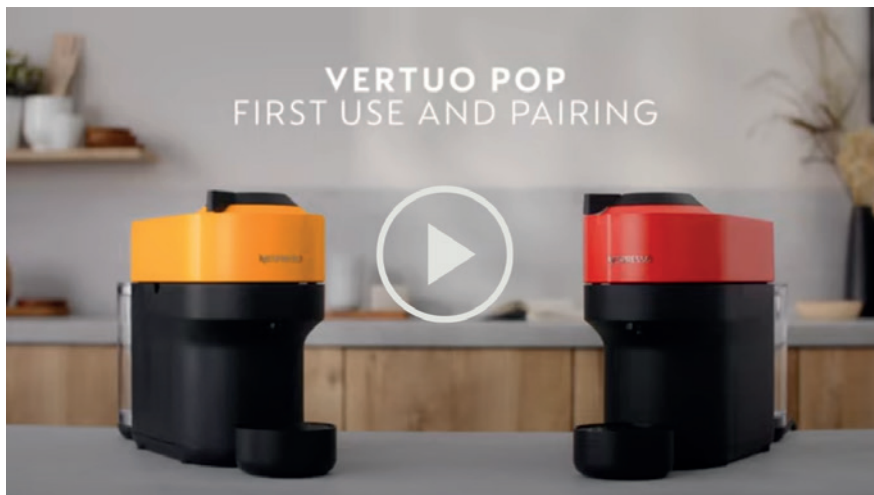

1 在注入新鲜常温饮用水之前，首先冲洗并清洁水箱和盖子。

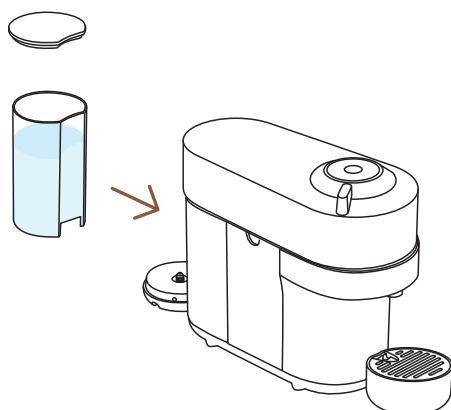

2 用盖子盖住水箱，将水箱放在适当的位置，并确保其正确连接。

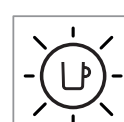
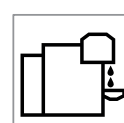
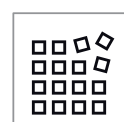
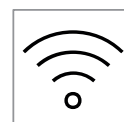

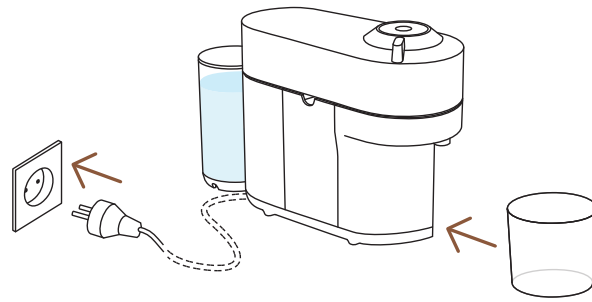

- 3** 连接电源的情况下, 取下杯托, 并在咖啡出口下方放置一个容量至少为1升的容器。

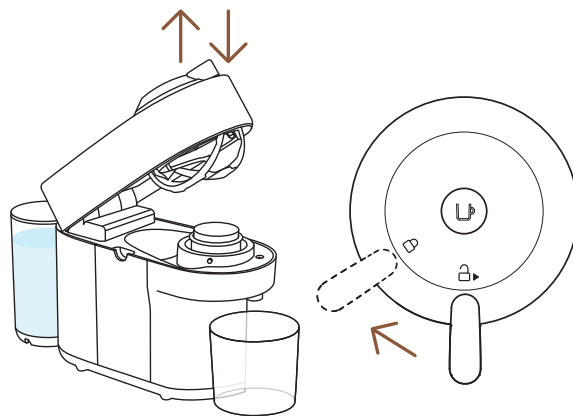

- 4** 打开并关闭机器。确保手柄处于锁定位置。

- i** 机器加热时, 指示灯会闪烁。此过程大约需要30秒。当灯光稳定时, 机器就准备好了。确保没有插入粉囊。

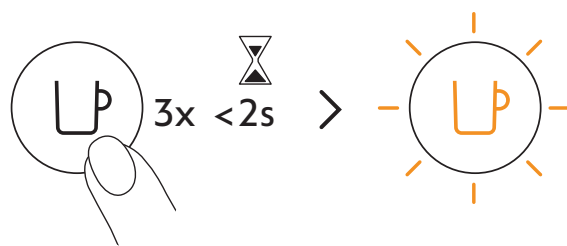

- 5** 在2秒内按下按键3次, 开始冲洗。橙灯闪烁的情况下, 让冲洗过程自动完成。当灯光变成稳定的白色时, 冲洗循环完成。

- i** 冲洗过程开始和水开始流动之前, 需要不到2分钟的时间。此过程最多可能需要 7 分钟。

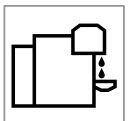
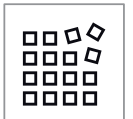

咖啡制备

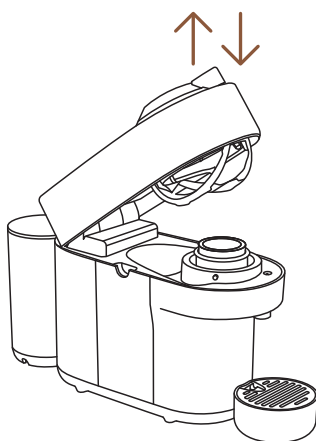

1 打开并关闭机器。

i 当机器加热时，咖啡按键指示灯将闪烁。当灯光稳定时，机器就可以使用了。

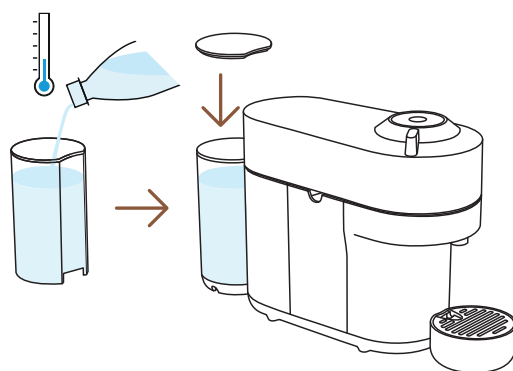

2 将新鲜常温饮用水注满水箱，然后将其放回原位。

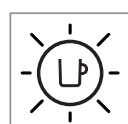
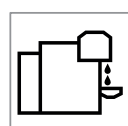
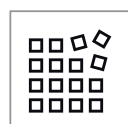
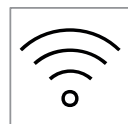

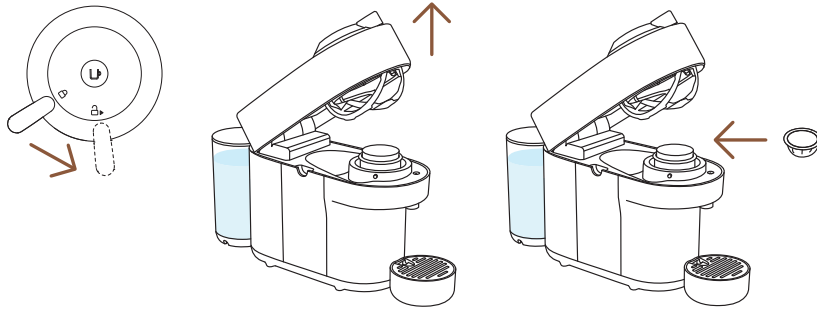

3 解锁并完全打开机头，朝下插入圆顶形状的Vertuo粉囊。

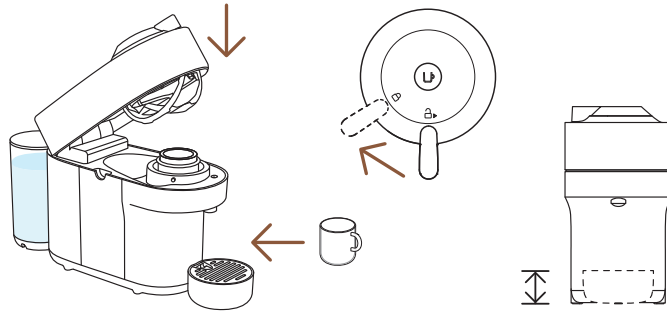

4 关闭机器头部并通过向左转动手柄锁定，直到锁定位置，然后放置一个杯子。杯托可以根据你的杯子尺寸进行调整。

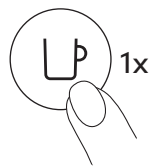

5 按下一次按键即可开始萃取。

注意:为正确使用咖啡机，请勿在机器运行时打开机头，等待机器的按键变为白色后再打开。如果你想提前停止萃取，请按下咖啡按键，等待机器停止，再打开机头。

i 由于条形码读取、咖啡预润湿和浸泡时间，咖啡开始流出需要一段时间。该机器将自动识别插入的粉囊，并选择**Nespresso**咖啡专家定义的咖啡制备参数和杯量，以提取最佳的咖啡混合物。

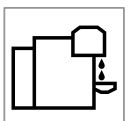
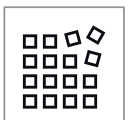

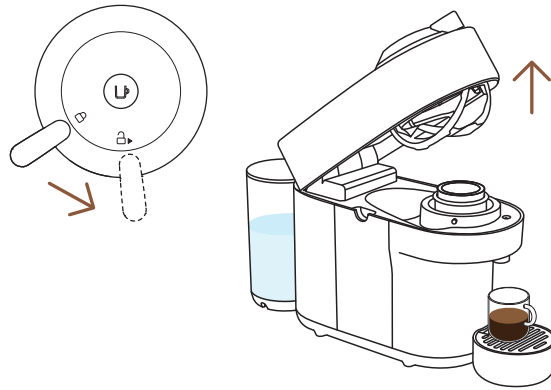

- 6** 当咖啡停止萃取时, 将手柄向右转动至解锁位置, 打开机头, 自动弹出粉囊, 享受你的咖啡。



- 7** 请勿忘记回收你的**Nespresso**咖啡粉囊。*

* **Nespresso**咖啡粉囊, 可回收的咖啡粉囊。
请登录www.nespresso.com获取更多回收信息

了解我们的咖啡创意模式



有了这台机器, **Nespresso**为你提供了一个特定的功能, 来专注于萃取属于你个人配方的咖啡。

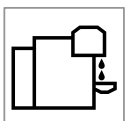
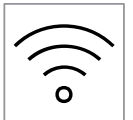

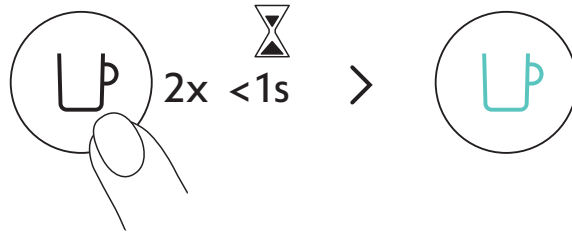

打开机器，双击咖啡按键。它会闪烁绿松石色，你会专注于咖啡萃取，通过添加添加物（牛奶、奶精、加冰等）优化配方中的咖啡味道。获得无与伦比的咖啡体验。

40 毫升	80 毫升	150 毫升	230 毫升	355 毫升	535 毫升
✓	✓	✓	✓	✗	✗
25 毫升	40 毫升	40 毫升	80 毫升		

为了充分享受这些好处，我们建议只使用官方尺寸的杯子来萃取我们的Coffee+系列。为了获得最佳的杯内效果，我们不建议用这种模式萃取我们的XL (Alto Ambrato、Alto Onice)、冷萃风格和分享咖啡风格。

注意：启用此模式可能需要通过**Nespresso**应用程序更新你的机器。



了解如何使用我们的Aeroccino系列升级你的机器，请访问www.nespresso.com



调节咖啡杯量

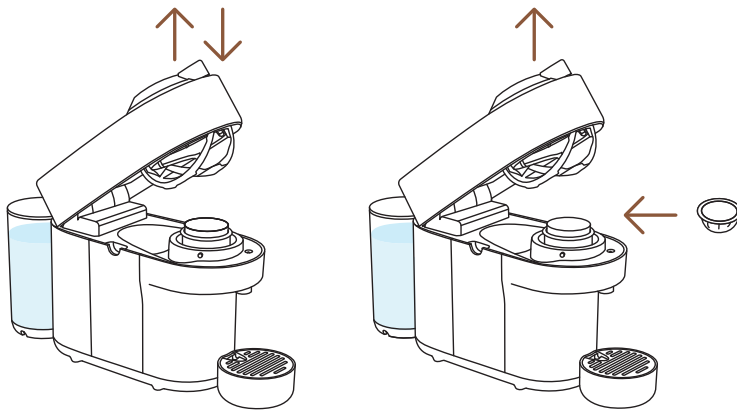

- 1** 打开并关闭机器。开机状态下，打开机头并插入要萃取的粉囊。

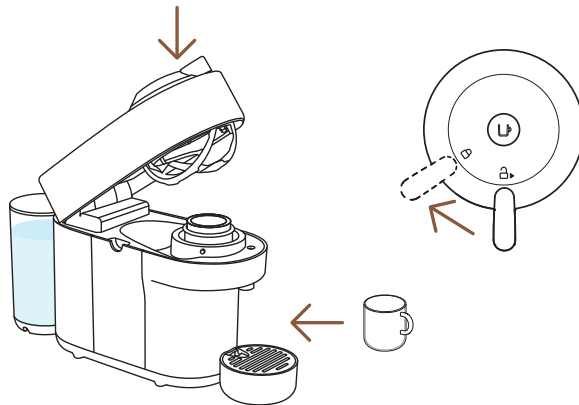

- 2** 关闭机头，将手柄向左转到锁定位置，然后放置一个杯子。

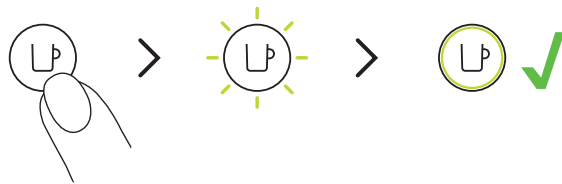

- 3** 长按按键直至达到理想杯量的前几秒松开按键 新杯量现在已针对设置过程中使用的粉囊类型进行设定。

i 此程序针对每种粉囊类型。杯量范围为20毫升至535毫升

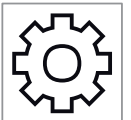
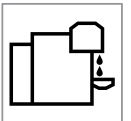
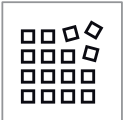
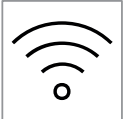

注意:为正确使用咖啡机,请勿在机器运行时打开机头,等待机器的按键变为白色后再打开。如果你想提前停止萃取,请按下咖啡按键,等待机器停止,再打开机头。

注意:一旦用户对客户特定的容量进行了编程,每次将该粉囊类型插入机器时,准备工作将停止在用户编程的杯量。如果你希望返回默认参数,请参阅“重置为出厂设置”一段。

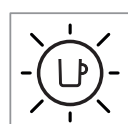
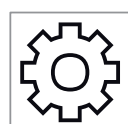
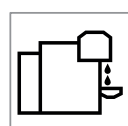
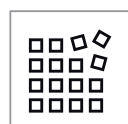
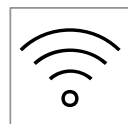

清洁

当你的机头内开始有咖啡残渣时, 或者在长时间不使用后, 每月清洁一次你的机器。

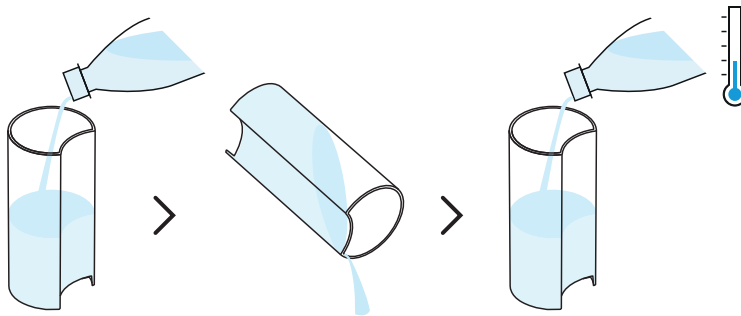

1 在装满新鲜常温饮用水之前, 先冲洗并清洁水箱和盖子。

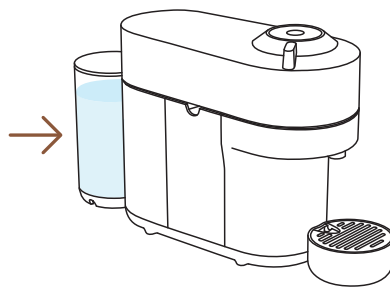

2 将水箱放回机器上的适当位置。

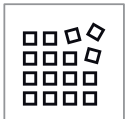

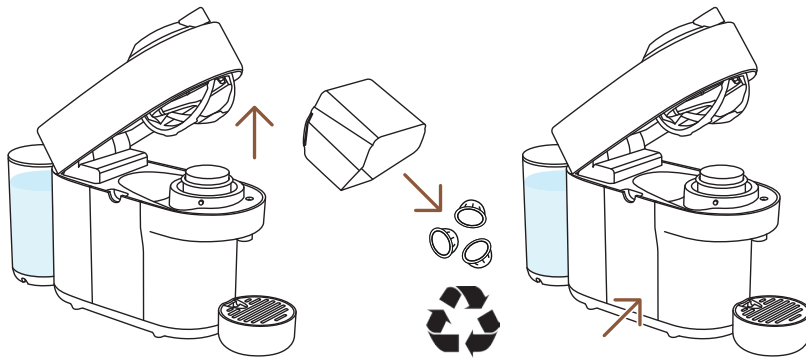

- 3** 开机状态下, 解锁并打开机头, 让用过的粉囊弹出。清空并冲洗废弃粉囊盒和滴水盘, 然后将它们放回原位。请勿忘记回收你的**Nespresso**咖啡粉囊。*

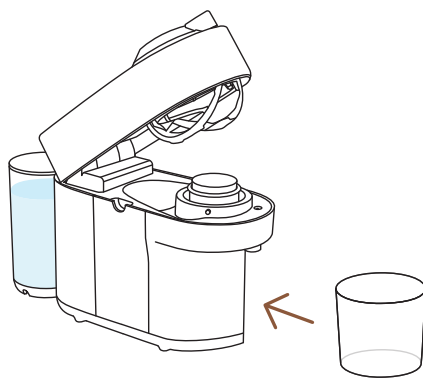

- 4** 取下杯托, 在咖啡出口下方放置一个容量至少为1升的容器。

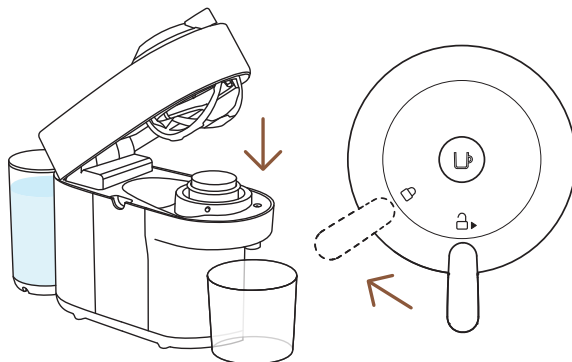

- 5** 关闭机器头部并将手柄向左转向锁定位置。在开始清洁程序之前, 确保机器中没有粉囊。

* **Nespresso**咖啡粉囊, 可回收的咖啡粉囊。
请登录www.nespresso.com获取更多回收信息

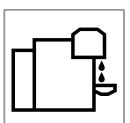

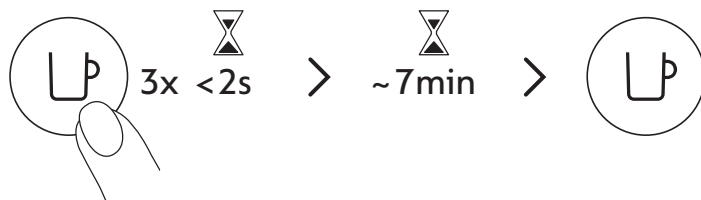

6 在2秒内按下按键3次, 开始冲洗。橙色指示灯闪烁下, 请让清洁程序自动完成。

i 在清洁过程开始和水开始流出之前, 应该需要不到2分钟的时间。此操作可能需要长达7分钟的时间, 循环完成后将自动停止。该过程可以随时通过按下按键停止。

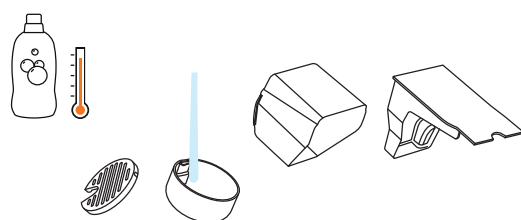

7 用热水和温和无味的洗涤剂清洗废弃粉囊盒、杯托和滴水盘。

注意: 不要使用任何强力或研磨性清洁剂或溶剂清洁剂。不要把机器放在洗碗机里。切勿将电器或其部分浸入水中。

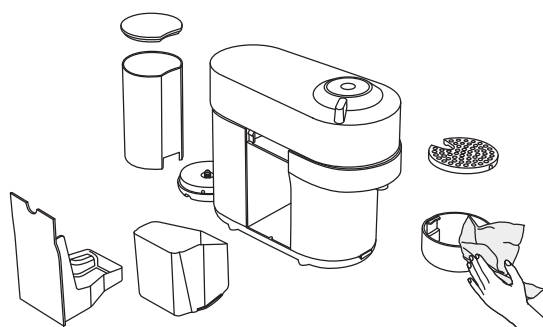

8 用干净、新鲜的毛巾擦干机器。

注意: 用干净的湿布定期清洁咖啡出口。务必使用软布清洁机器。

注意: 水可能积聚在机器头部内, 请用清洁的干布将可见部件擦干

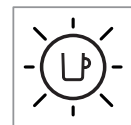
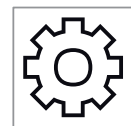
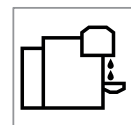
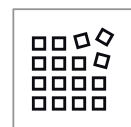
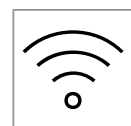

除垢

对机器进行除垢将确保其在使用寿命内正常工作,并使你的咖啡体验与第一天一样无与伦比。
你的机器将在稳定的白灯之前通过闪烁3次橙色来指示何时需要除垢。



i 除垢过程大约需要20分钟,并且不能中断。

注意:除垢开始前,请仔细阅读除垢说明

你将需要:

- 可在www.nespresso.com网站上购买除垢剂
- 一个容量为1升的容器

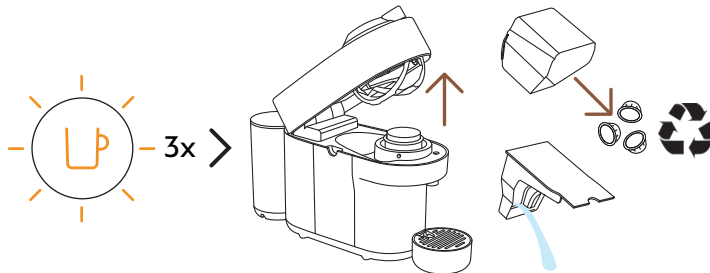

1 按键橙色闪烁3次: 解锁并打开机头,让用过的粉囊弹出。清空废弃粉囊盒和滴水盘,然后将它们放回机器上的适当位置。请勿忘记回收你的**Nespresso**咖啡粉囊。*

* **Nespresso**咖啡粉囊,可回收的咖啡粉囊。
请登录www.nespresso.com获取更多回收信息

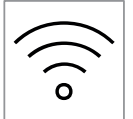

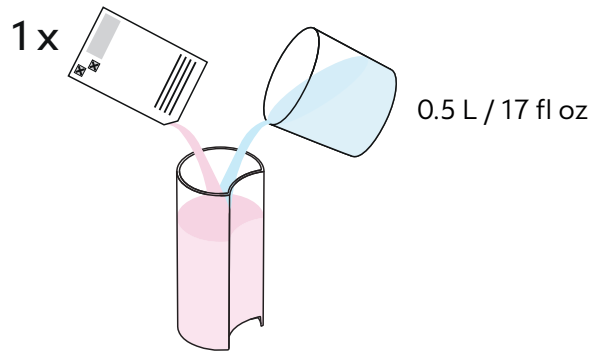

2 在水箱中加入0.5升的水, 并加入1份**Nespresso**除垢液。

注意: 请注意, 除垢液可能有害。
避免接触眼睛、皮肤和表面。

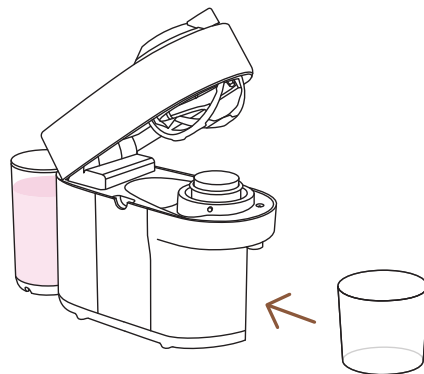

3 取下杯托, 在咖啡出口下方放置一个容量至少为1升的容器。

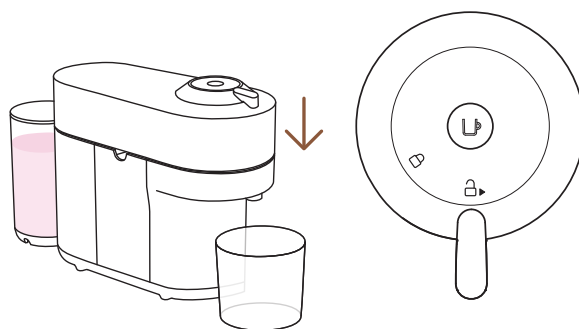

4 在机器打开的情况下, 关闭机器头部并将手柄留在解锁位置。

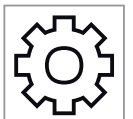
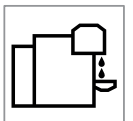

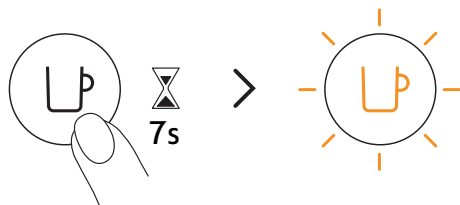

- 5** 按住按键至少7秒钟, 或者直到看到按键灯熄灭。按键灯将开始快速闪烁橙色。

注意: 你现在有45秒的时间进入除垢模式, 否则机器将返回萃取模式。

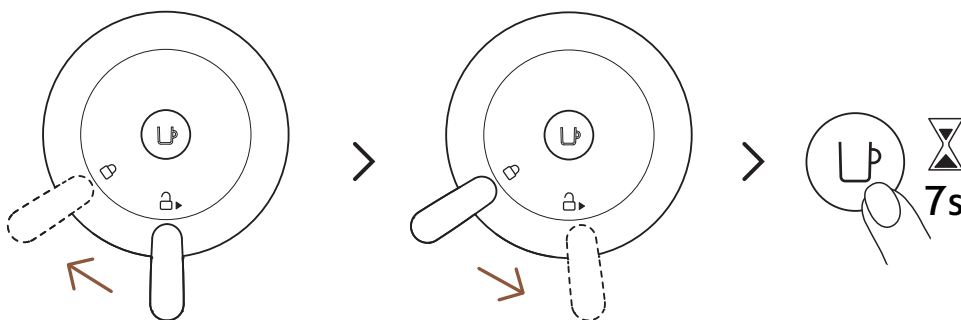

- 6** 向左转动手柄直至锁定符号, 以锁定机器头部, 然后向右转动至解锁位置, 以解锁手柄。再次按住该按键约7秒或直至指示灯熄灭。该按键将开始快速闪烁橙色。

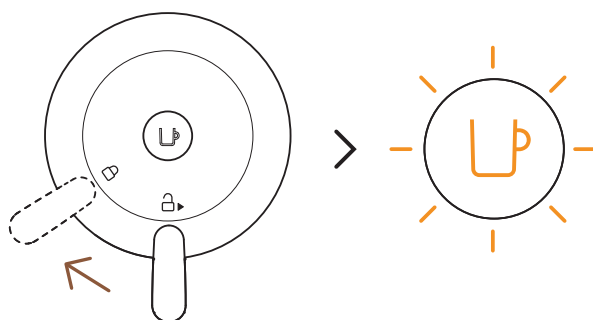

- 7** 要进入除垢模式, 请将手柄向左转动至锁定位置以锁定机器。指示灯仍应快速闪烁为橙色。这表示你已进入除垢模式。

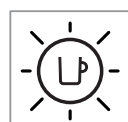
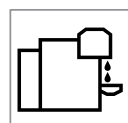
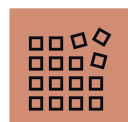
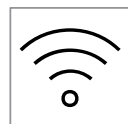

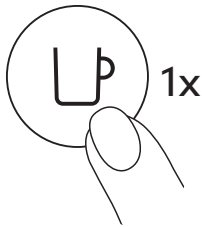

- 8** 按下咖啡按键一次, 开始除垢程序, 过程中橙色指示灯会持续闪烁。

i 第一阶段除垢完成后, 机器将自动停止。

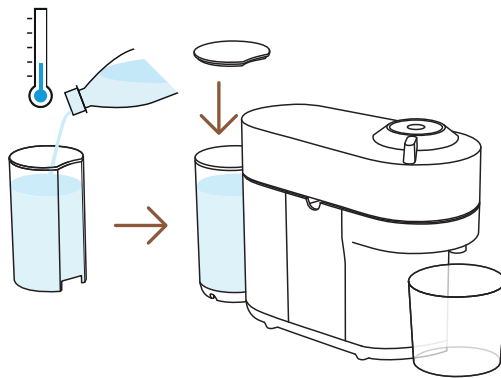

- 9** 在除垢过程结束时, 是时候冲洗机器了。
彻底冲洗水箱和滴水盘。
将新鲜常温饮用水注满水箱, 然后将其放回原位。
清空容器并将其放回咖啡出口下方。

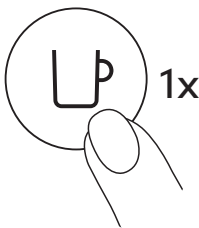

- 10** 按下按键冲洗机器。当按键灯快速停止闪烁并变得稳定时, 除垢程序完成。

i 程序完成后, 机器将自动停止。

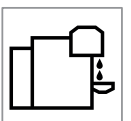
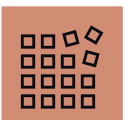
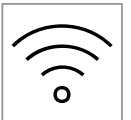

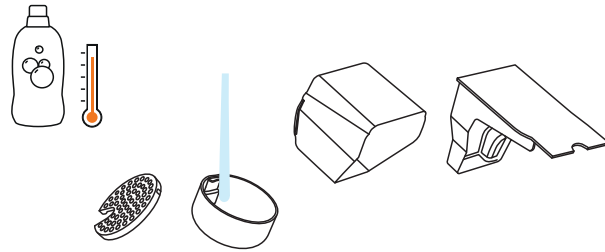

11 用热水和温和无味的洗涤剂清洗废弃粉囊盒、杯托和滴水盘。

注意: 不要使用任何强力或研磨性清洁剂或溶剂清洁剂。
不要把机器放在洗碗机里。
切勿将电器或其部分浸入水中。

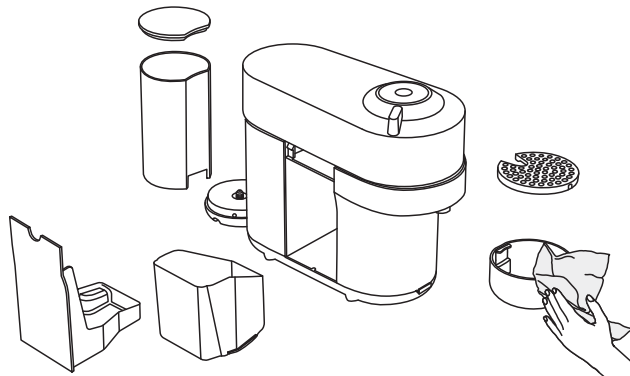

12 用干净、新鲜的毛巾擦干机器。
让机器干燥10分钟后再使用。

注意: 清洗过程中, 机器头部可能会积水。
如果出现这种情况, 请用干净的干布擦干可见部分。

注意: 只有在萃取了30杯或30杯以上的咖啡后, 机器才能进入除垢模式。

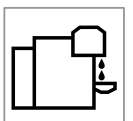
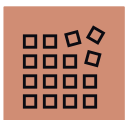

清空系统

清空程序是一个可以在一段时间不使用之前、为了防冻或在送机器维修之前进行的过程。

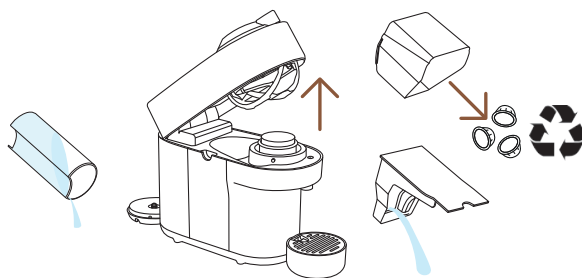

- 1 清空水箱, 打开机头, 让用过的粉囊弹出。
清空废弃粉囊盒和滴水盘。
请勿忘记回收你的**Nespresso**咖啡粉囊。*

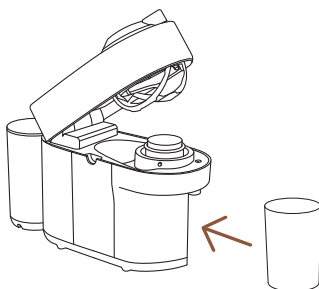

- 2 将它们放回机器上的适当位置, 取下杯托, 并在咖啡出口下方放置一个容量至少为0.5升的容器

* **Nespresso**咖啡粉囊, 可回收的咖啡粉囊。
请登录www.nespresso.com获取更多回收信息

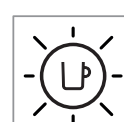
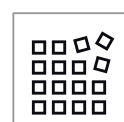
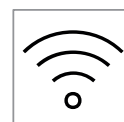

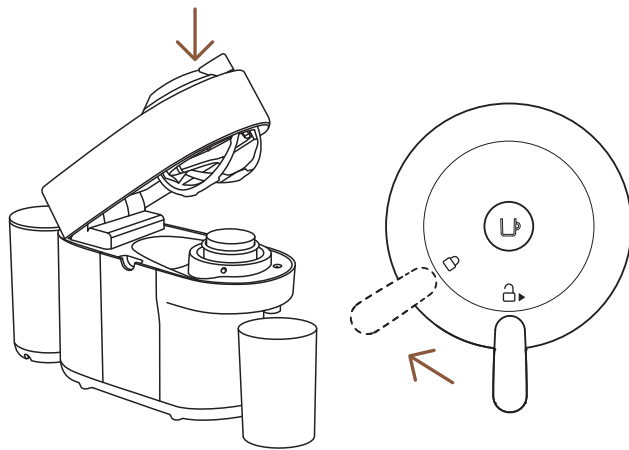

3 在连接电源及开机状态下, 将手柄转向锁定位置。

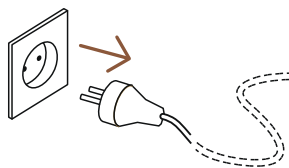

4 拔下机器电源插头。

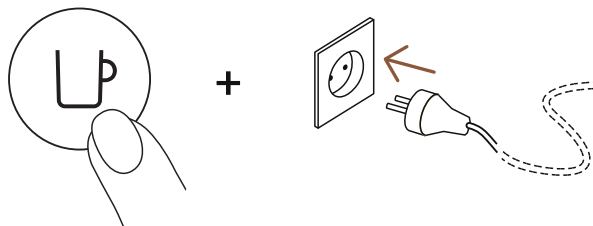

5 插入电源时按住按键。

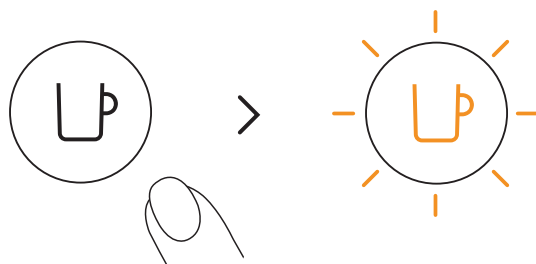

6 松开按键。
它将闪烁橙色, 排空过程将开始。

i 机器完成排空过程大约需要30秒。
机器空的时候自动关机。



恢复出厂设置

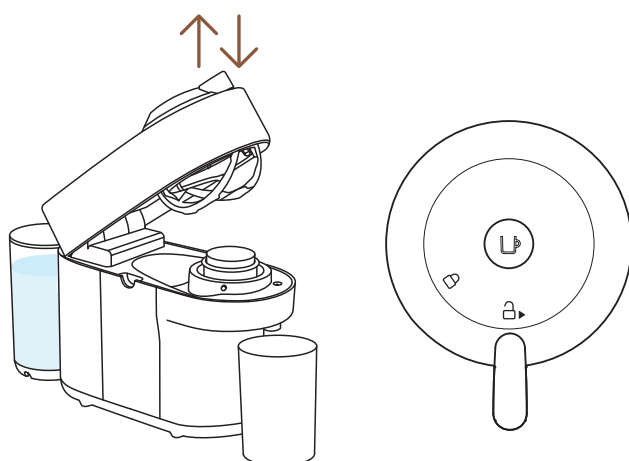

- 1** 在机器连接电源情况下, 打开并关闭机头, 然后将手柄留在解锁位置。

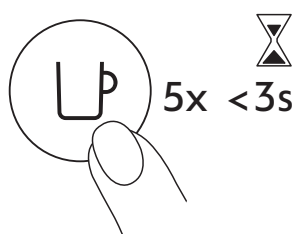

- 2** 3秒内按下按键5次 机器现在已按照出厂设置进行编程。

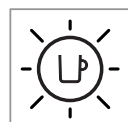
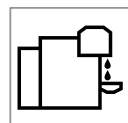
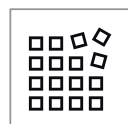
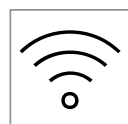

按键灯提示

你想知道更多关于Vertuo Pop闪灯的信息吗？
请观看以下视频：

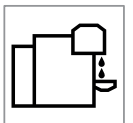
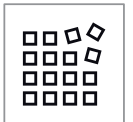

故障排除

按键没有灯亮

- 机器已经自动关机;按下按键或“解锁”机器。
- 检查电源、插头、电压和保险丝。

不出咖啡, 不出水。

- 检查水箱是否有水。
- 检查新的粉囊放置在正确的位置, 手柄已正确锁定, 然后按下按键开始。
- 如果必要请除垢。
- 打开机头, 让粉囊弹出。然后按照清洁章节指示进行清洁。

咖啡不够热。

- 用可饮用热水预热杯子。
- 如果必要请除垢。

渗漏或咖啡异常流量。

- 检查水箱位置是否正确。
- 如果必要请除垢。

机器转到“关闭模式”。

- 为节省能源, 机器在未使用2分钟后会关闭。
- 按住按键3秒钟, 机器可以随时手动“关闭”(不使用时)。

杯中残留咖啡渣。

- 执行两次清洁程序。
- 请查阅“清洗”章节。

机器无法启动, 并且按键灯一直亮着。如果按键灯闪烁, 请查阅后续要点。

- 检查手柄是否正确锁定。
- 如果你想萃取一杯咖啡或浓缩咖啡, 请检查未使用的粉囊是否已正确放置, 手柄是否正确锁定, 然后按下按键开始。
- 如果你想清洗、除垢或清空系统, 请检查机器未放入粉囊, 然后关闭锁定机器, 按下按键开始其中之一的操作。

机器无法启动, 按键闪烁交替:1次闪烁与1次暂停。

- 水箱加水然后按键开始。
- 检查手柄是否正确锁定。

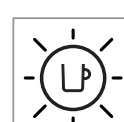
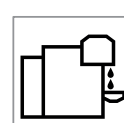
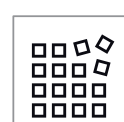
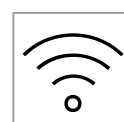

机器运行中按键闪烁。

- 如果出咖啡正常, 表示机器正常工作中。
- 如果只有水在流动, 则机器正在执行用户对系统进行清洁、除垢或排空的请求。请参考相应章节内容。
- 按下按键3秒钟, 将机器转到“关闭模式”, 然后再次按下按键以打开机器。
现在等待大约20分钟, 让机器在大量使用后冷却下来。

机器无法启动, 按键闪烁交替:1次闪烁与1次暂停。

- 咖啡出来前需要等待一段时间(条形码读取及浸泡咖啡)。
- 检查新的粉囊放置在正确的位置, 手柄已正确锁定, 然后按下按键开始。
- 水箱加水然后按键开始。
- 按下按键3秒钟, 将机器转到“关闭模式”, 然后再次按下按键以打开机器。
现在, 等待大约20分钟, 让机器在大量使用后冷却下来。

按键交替闪烁:持续2次闪烁与1次暂停。机器没有运行。

- 在正常咖啡/浓缩咖啡制备中:
 - 1) 解锁手柄, 打开机头检查未使用且完好的粉囊放置在正确位置。
 - 2) 检查手柄在“锁定”位置。
 - 3) 检查水箱是否有水。
- 在除垢、清空与清洗中:
 - 1) 检查粉囊已弹出。
 - 2) 检查手柄在“锁定”位置。
- 在杯量识别程序中:
 - 1) 检查粉囊是否插入良好。
 - 2) 请参考相应章节内容。
- 如果问题仍然存在:
 - 1) 解锁手柄然后打开机头。
 - 2) 更换粉囊(如果需要)。
 - 3) 拔下电源插头, 然后10秒后重新插上电源插头。
 - 4) 合上机头, 然后按下按键开机, 然后再次按键开始萃取。
 如果问题依然存在, 请联系 **Nespresso**。

按键灯交替闪烁3次后稳定发光。

- 建议除垢: 当此警告仅出现几次时机器可以操作, 但是如持续出现, 则有必要进行除垢。

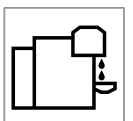
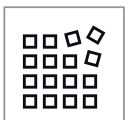

规格

功率	~220-240 V, 50-60 Hz, 1300-1500 W US, CA: 120 V, 60 Hz, 1500 W MX: 127 V~, 60 Hz, 1380 W CN: 220 V~, 50 Hz, 1300 W
频率	2.402-2.480 GHz
射频输出功率(EIRP)	蓝牙4 dBm最大射频输出功率和Wi-Fi小于20 dMm最大射频输出功率
待机	0.39 W/h
省电模式	自动关机:2分钟
加热时间	30秒(头部闭合并锁定)
适用于大型配方的可移动杯托	可拆卸单个位置
从设备调度开始的电缆长度	75 厘米 / 30 英寸
尺寸(长x宽x高)	13.6 x 42.6 x 25 cm / 5.3 x 16.7 x 9.8 in
重量	3.5 kg / 7.72 lbs
水箱容量	600 ml / 20 fl oz
废弃粉囊盒容量	8个意式浓缩咖啡或5个马克杯咖啡粉囊

机器代码

Nespresso	Breville	Delonghi
GCV2, GDV2	BNV120, BNV150	ENV90
Krups	Magimix	
XN9201, XN9204, XN9205, XN9211	M800	

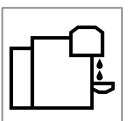
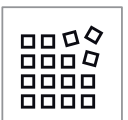

언어를 선택해 주십시오

KR



안전 수칙



개요



커넥티비티 기능



처음 사용하기



커피 추출하기



추출량 설정하기



청소하기



디스케일링



머신 내부의 물 비우기



공장 출하 설정값으로 초기화



버튼 불빛 깜빡임 요약



문제 해결



제품 사양

안전 수칙

주의: 상해나 위험을 방지하기 위하여 제품을 사용하기 전에 반드시 안전 수칙을 참조 하십시오.

머신 폐기 및 환경 보호

이 머신은 유럽연합(EU) 지침 2012/19/EC 를 준수합니다.
포장재 및 머신은 재활용 가능한 재료들을 포함하고 있습니다.
폐기시 원재료별로 분리 배출하면 재활용이 쉬워집니다. 소형 폐
가전 머신 무상 수거 등을 이용하여 머신을 폐기할 수 있습니다.
머신 폐기에 관한 정보는 거주지 관할 관청에서 얻으실 수
있습니다.

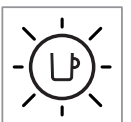
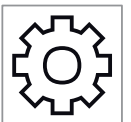
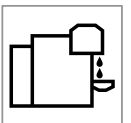
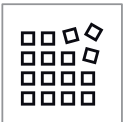

개요

각 부분별 이름

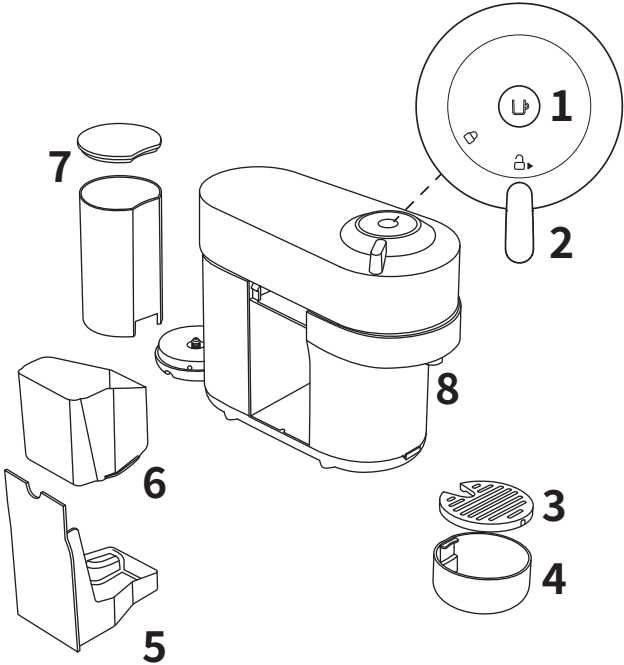

- 1 전원/커피 버튼
- 2 잠금/잠금 해제 레버
- 3 드립 그리드
- 4 높이 조정이 가능한 컵 받침
- 5 드립 트레이
- 6 캡슐 컨테이너
- 7 물통과 뚜껑
- 8 커피 추출구

제품 구성



- 1 커피 머신
- 2 네스프레소 웰컴 기프트 커피
- 3 네스프레소 웰컴 안내 책자
- 4 안전 수칙
- 5 간단 사용 설명서
- 6 제품 보증서

i 박스 개봉: 재활용된 포장재 사용으로 인해 머신 표면에 먼지가 있을 수 있습니다. 위험한 물질이 아니니, 깨끗한 종이 타월로 닦아 주십시오

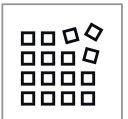

헤드 열기 / 닫기

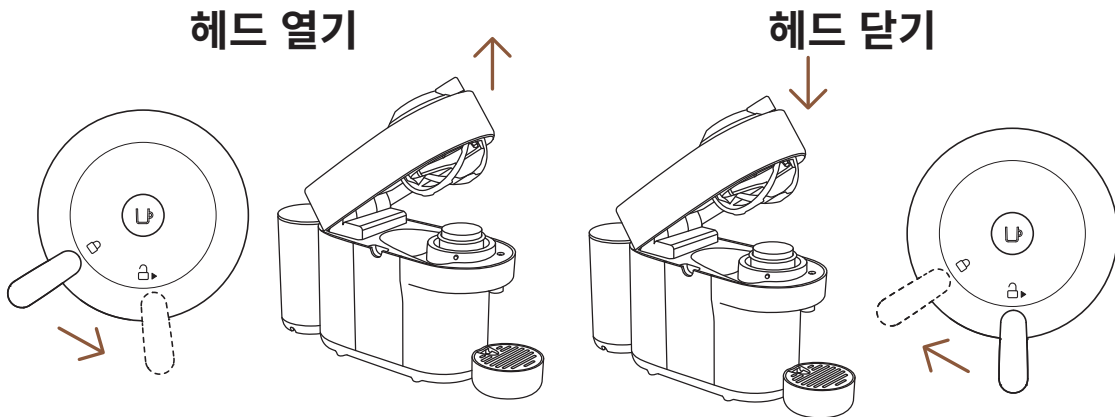

주의: 머신이 작동 중일 때는 절대로 머신의 헤드를 열지 말고 머신 버튼이 깜박이지 않고 흰색으로 점등된 상태로 바뀔 때까지 기다리십시오. 추출을 중단하고 싶다면 커피 버튼을 누르고 머신이 멈출 때까지 기다렸다가 헤드를 여십시오.



버추오 커피 시스템

캡슐 호환 여부

			
S	M	L	XL
에스프레소 (40 ml)	더블 에스프레소 (80 ml) 그랑 룡고 (150 ml)	머그 (230 ml)	알토, 콜드 브루 (355 ml) 카라프 (535 ml)

액세서리 호환 여부

✓						
액세서리 호 환 여부	에스프레소	더블 에스프 레소	그랑 룡고	머그 (S)	머그 (M)	리빌 콜드 글라스

✗		
사용에 적합하 지 않은 액세 서리	머그 (L)	카라프

www.nespresso.com 에서 모든 액세서리 컬렉션을 확인하십시오.

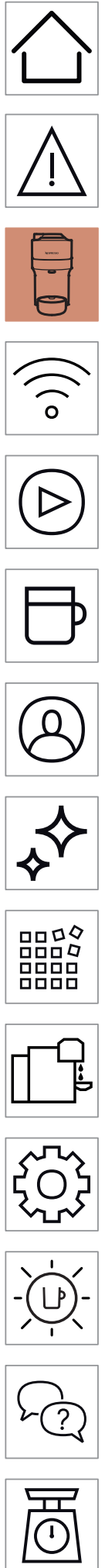

켜기/끄기

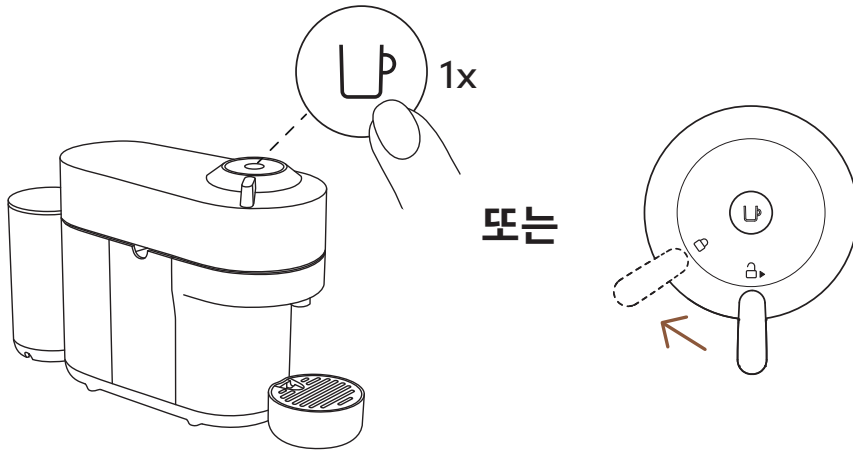

켜기

머신의 전원 플러그를 연결하고, 버튼을 한번 누르거나 헤드를 닫고 레버를 잠가 전원을 켭니다.

- i** 머신은 약 30초 동안 예열되며, 예열되는 동안 불빛이 깜빡입니다. 불빛이 계속 켜져 있으면, 머신은 사용할 준비가 된 것입니다.

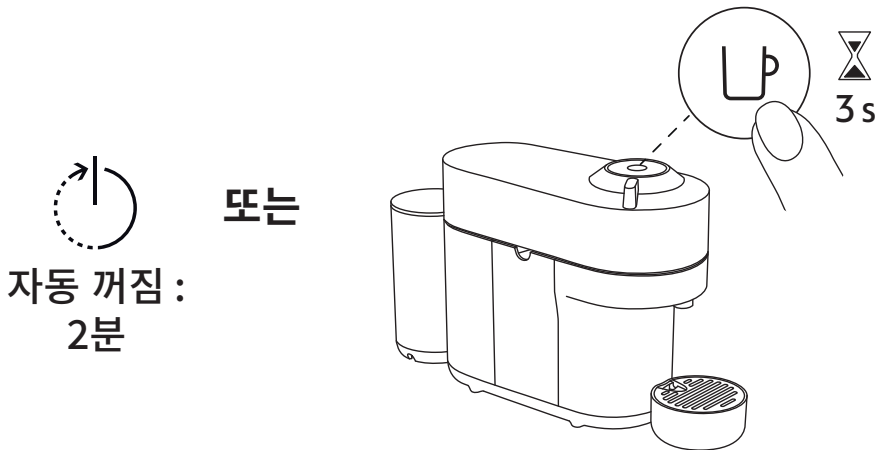

끄기

에너지 절약을 위해 2분 동안 머신을 사용하지 않으면 자동으로 전원이 꺼집니다.

- i** 머신이 작동 중이 아닐 때, 버튼을 3초간 눌러 수동으로 머신의 전원을 끌 수 있습니다.

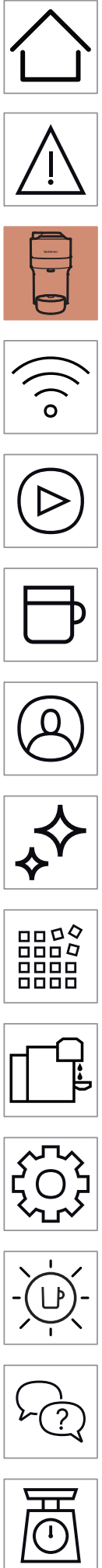

커넥티비티 기능

버추오 팝 머신을 페어링해야 하는 이유



버추오 팝 머신 커넥티비티 기능의 다양한 혜택

- **최적화된 커피 레시피:** 머신을 항상 최신 상태로 유지하도록 자동으로 소프트웨어를 업데이트하여 **네스프레소의** 최적화된 추출 레시피로 커피를 즐기십시오.
- **전문가 어드바이스:** 스마트폰을 통해 머신 관리에 대한 지원 및 안내를 받으실 수 있습니다.
- **스마트한 머신 관리:** 디스케일링, 헹구기 및 청소하기와 같은 과정을 실시간으로 안내 받을 수 있습니다.

버추오 팝 머신과 모바일 기기 연결하기

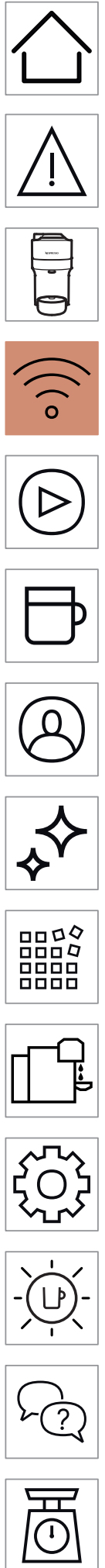

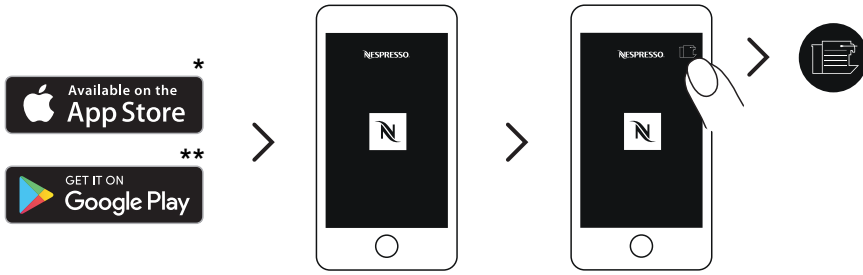

1 네스프레소 앱을 다운로드 하거나 최신 버전으로 업데이트 합니다. 스마트폰 또는 태블릿을 통해 앱을 실행합니다. 화면 오른쪽 상단의 머신 아이콘을 클릭합니다.

중요: 최적의 성능과 원활한 사용을 위해, 스마트폰 핫스팟이 아닌 Wi-Fi 공유기에 머신을 연결하는 것이 좋습니다. 5GHz Wi-Fi에는 연결이 불가능합니다.

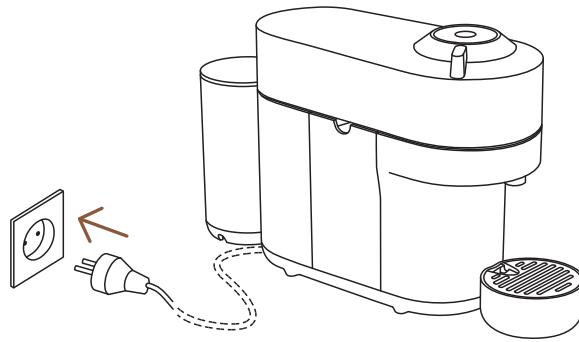

2 전원 플러그를 연결합니다.



3 앱의 안내에 따라 "블루투스/Wi-Fi와 연결하여 머신 등록하기" 혹은 "연결 없이 머신 등록하기"를 선택합니다.

주의: 먼저 치명적인 전기 감전 사고 및 화재를 예방하기 위해 안전 수칙을 확인하십시오. 반드시 접지된 콘센트에 머신을 연결하여 사용하십시오.

* App Store®는 미국 등의 국가에 등록된 애플(Apple Inc.)의 상표입니다.
 ** Google Play 및 Google Play의 로고는 구글(Google LLC)의 상표입니다.

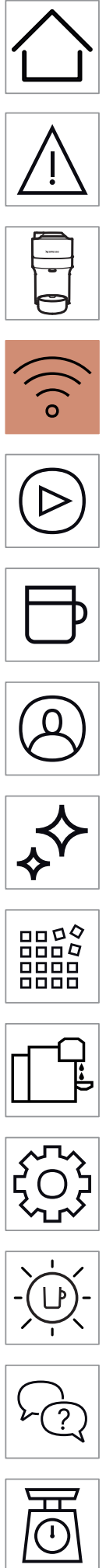

커넥티비티 모듈(블루투스, 와이파이) 비활성화하기

머신에는 기본적으로 커넥티비티 모듈이 활성화되어 있습니다. 커넥티비티 기능을 이용해 자동으로 소프트웨어를 업데이트하여 네스프레소의 최적화된 추출 레시피로 커피를 즐기십시오. 커넥티비티 모듈을 비활성화 하려면, 다음 단계를 따릅니다:

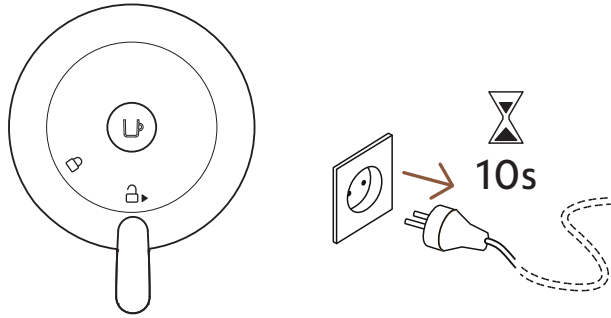

- 1** 머신 헤드를 닫고 레버는 **잠금 해제** 위치에 그대로 둔 상태로 머신의 전원 플러그를 뽑고 10초 이상 기다립니다.

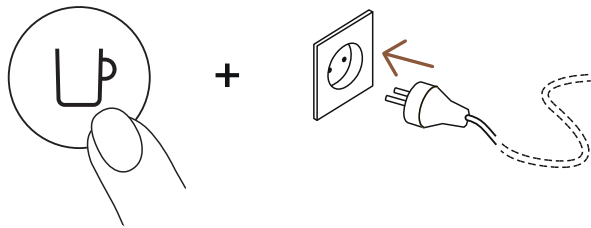

- 2** 버튼을 누른 상태로 플러그를 연결합니다. 버튼이 주황색으로 깜빡이면, 커넥티비티 모듈이 비활성화 된것을 나타냅니다.

- i** 커넥티비티 모듈을 다시 활성화 하려면 앞의 단계를 동일하게 반복합니다. 버튼이 흰색으로 깜빡이면, 커넥티비티 모듈이 활성화 된것을 나타냅니다.

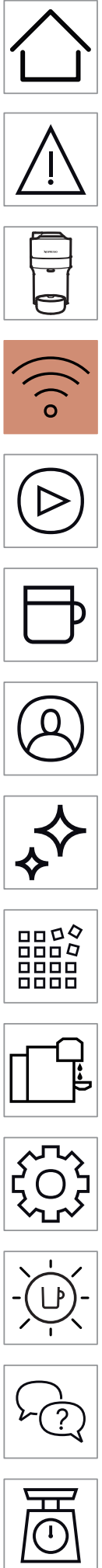

처음 사용하기

처음 사용시 세척하기

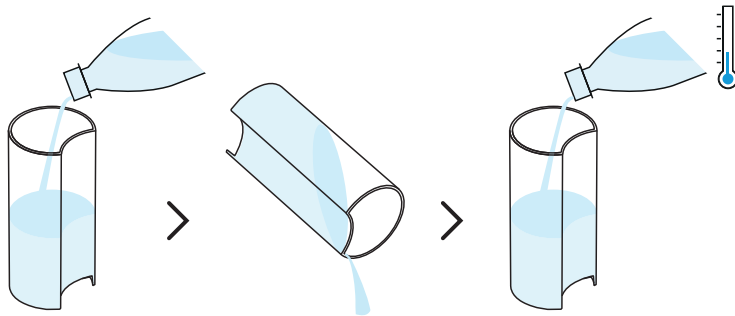

1 먼저 물통과 뚜껑을 깨끗한 물로 헹구고 깨끗한 음용수로 물통을 채웁니다.

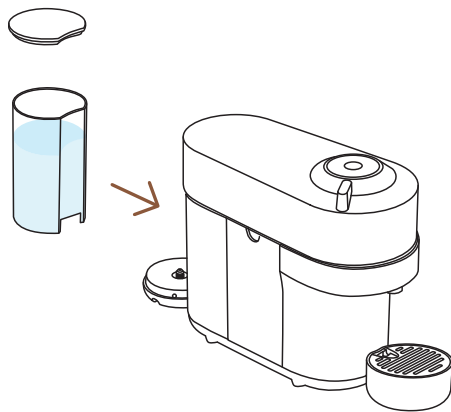

2 물통 뚜껑을 닫고 물통을 머신에 올바르게 장착합니다.

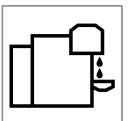
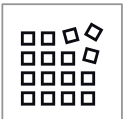
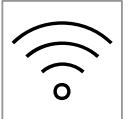

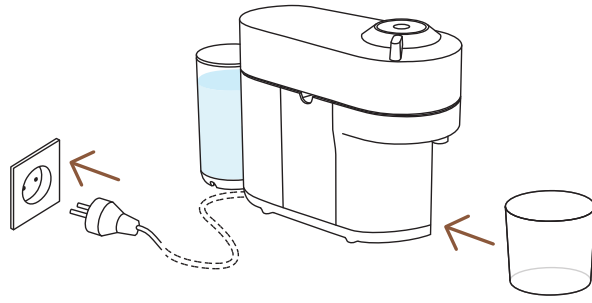

- 3** 전원 플러그를 연결하고, 컵 받침을 제거합니다. 커피 추출구 아래에 1 L 이상의 빈 용기를 놓습니다.

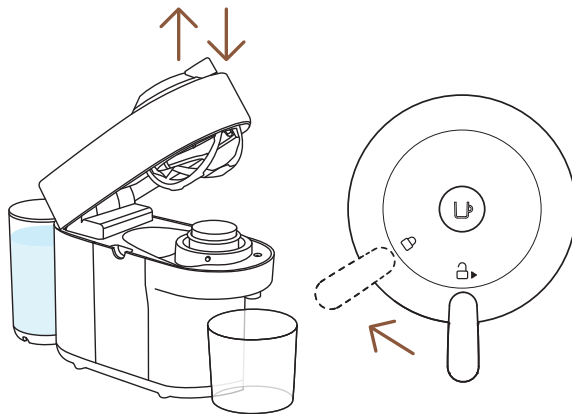

- 4** 머신 헤드를 열었다가 닫습니다. 레버를 잠급니다.

- i** 머신이 예열되는 동안 불빛이 깜빡입니다. 머신은 약 30초 동안 예열됩니다. 불빛이 계속 켜져 있으면, 머신은 사용할 준비가 된 것입니다. 캡슐 투입구에 캡슐이 없는지 확인합니다.

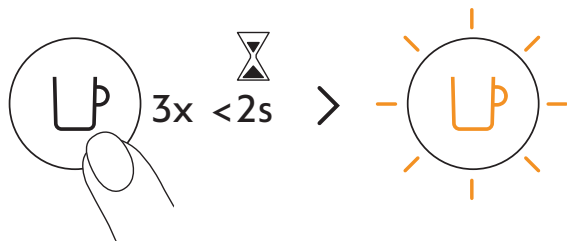

- 5** 버튼을 2초 이내에 3번 누릅니다. 주황색 불빛이 깜빡이고, 행굼 과정이 자동으로 완료되도록 기다립니다. 하얀색 불빛이 계속 켜져 있으면, 행굼 과정이 완료된 것입니다.

- i** 행굼 과정을 시작하고 2분 이내에 커피 추출구로 뜨거운 물이 나오기 시작합니다. 행굼 과정은 최대 7분이 소요됩니다.



커피 추출하기

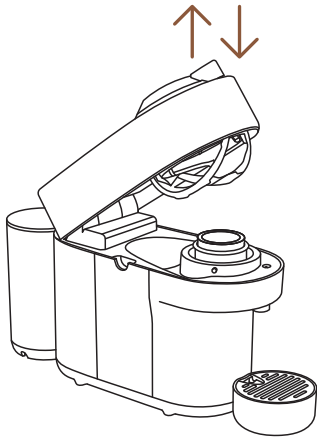

1 머신 헤드를 열었다가 닫습니다.

i 머신이 예열되는 동안 불빛이 깜빡입니다. 불빛이 계속 켜져 있으면, 머신은 사용할 준비가 된 것 입니다.

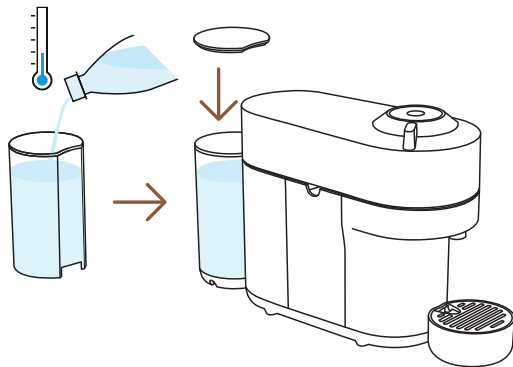

2 깨끗한 음용수로 물통을 채우고 물통을 머신에 올바르게 장착합니다.



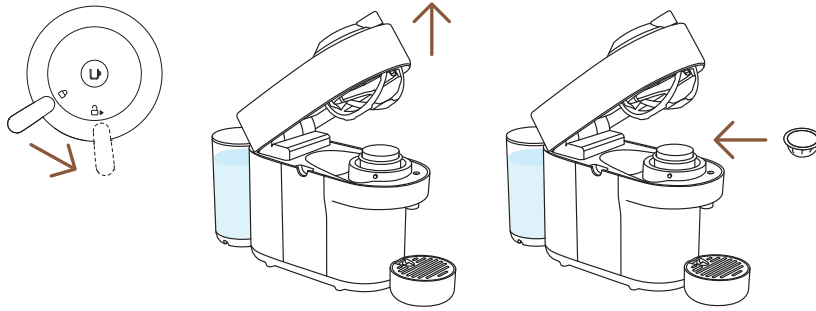

3 레버를 오른쪽으로 끝까지 돌려 머신 헤드를 열고 둥근 모양이 아래를 향하도록 버추오 캡슐을 넣습니다.

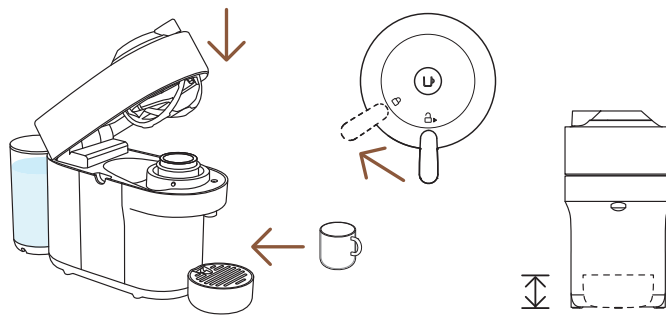

4 머신 헤드를 닫고 잠금 위치까지 레버를 돌립니다. 커피 추출구 아래에 컵을 놓습니다. 컵 받침의 위치를 알맞게 조정합니다.

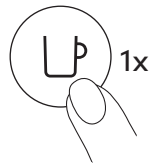

5 커피 버튼을 눌러 커피를 추출합니다.

주의: 머신이 작동 중일 때는 절대로 머신의 헤드를 열지 마시고 머신 버튼이 깜박이지 않고 흰색으로 점등된 상태로 바뀔 때까지 기다리십시오. 추출을 중단하고 싶다면 커피 버튼을 누르고 머신이 멈출 때까지 기다렸다가 헤드를 여십시오.

i 바코드를 읽고 프리 인퓨전 과정을 진행하기 때문에 커피가 추출되기까지 약간의 시간이 소요됩니다. 머신은 투입된 캡슐을 자동으로 인식하고 캡슐마다 네스프레소의 최적화된 추출 레시피로 커피를 추출합니다.

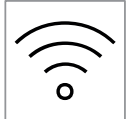

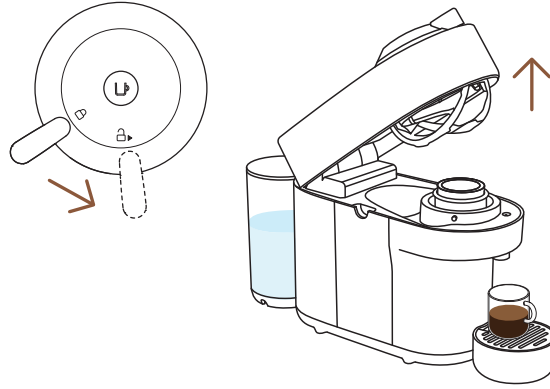

6 커피 추출이 끝나면, 레버를 오른쪽으로 끝까지 돌려 머신 헤드를 엽니다. 머신의 헤드를 열면 사용한 캡슐이 배출됩니다. 머신의 헤드를 닫습니다.



7 네스프레소 캡슐을 재활용 하십시오.*

* THIS IS **NESPRESSO**. THIS IS RECYCLABLE. 캡슐 재활용에 관한 자세한 정보는 공식 **홈페이지**에서 확인하실 수 있습니다
www.nespresso.com

아이스&라테 모드 알아보기



네스프레소는 버추오 팝 머신으로 다양한 커피 레시피(아이스, 라테 등)를 만드는 데 적합하도록 커피를 진하게 추출하는 특별한 기능을 제공합니다.



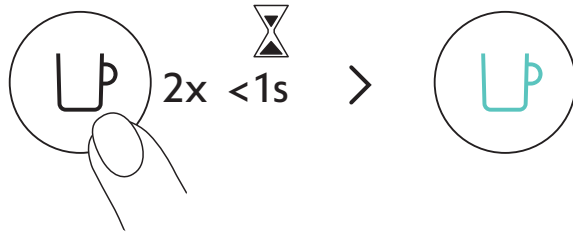

머신의 전원이 켜진 상태로, 커피 버튼을 빠르게 두번 눌러 추출합니다(청록색 불빛). 불빛이 청록색으로 깜빡이고 진한 커피가 추출됩니다. 우유, 크림 또는 얼음을 더해 즐기기에 적합하도록 커피 맛이 최적화됩니다.

40 ml	80 ml	150 ml	230 ml	355 ml	535 ml
✓	✓	✓	✓	✗	✗
25 ml	40 ml	40 ml	80 ml		

커피 플러스(Coffee+), 알토, 콜드 브루 스타일 및 카라프 푸어 오버 스타일 제품군은 아이스&라테 모드를 이용하여 추출하는 것을 권장하지 않습니다. 최적화된 레시피를 위해 캡슐에 설정된 추출량 그대로 추출하는 것을 권장합니다.

중요: 아이스&라테 모드를 이용하려면, **네스프레소** 앱의 커넥티비티 기능을 이용해 머신을 업데이트해야 할 수 있습니다.



www.nespresso.com 에서 에어로치노 제품군을 통해 커피 경험을 업그레이드하는 방법을 알아보십시오.

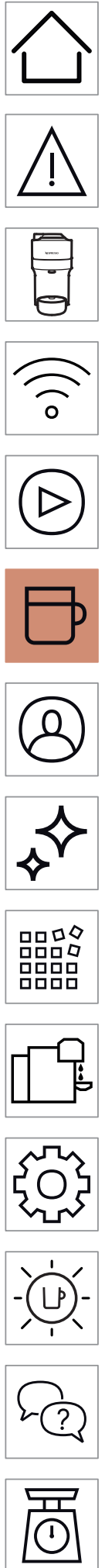

추출량 설정하기

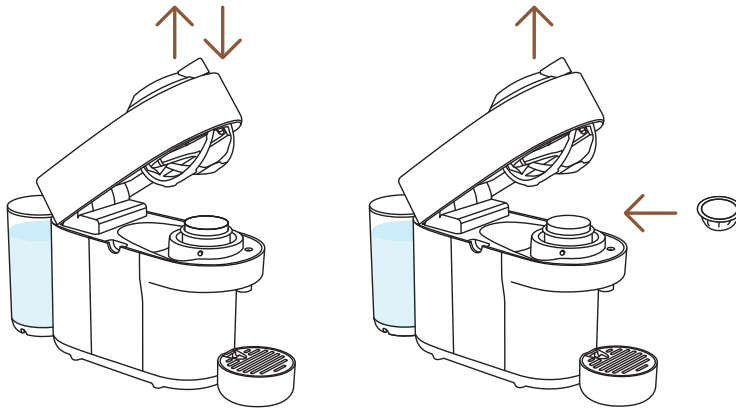

- 1** 머신 헤드를 열었다가 닫습니다. 머신의 전원이 켜진 상태로, 헤드를 열고 추출량을 설정할 캡슐을 넣습니다.

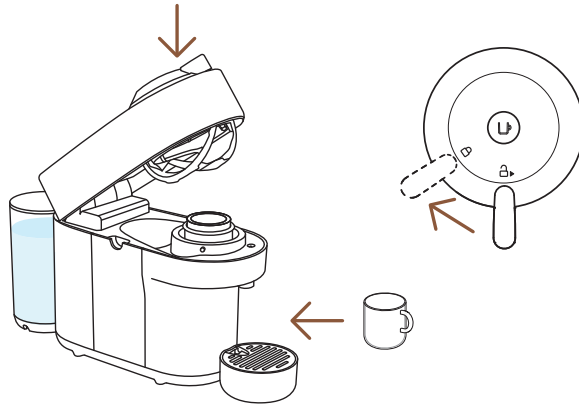

- 2** 머신 헤드를 닫고 잠금 위치까지 레버를 돌립니다. 커피 추출구 아래에 컵을 놓습니다.

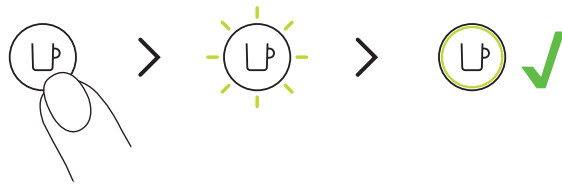

- 3** 원하는 양이 추출되기 몇 초전까지 버튼을 계속 누르다가 손을 뗍니다(커피 추출은 손을 떼고 몇 초간 더 추출되다가 멈춥니다). 이제 추출량을 다시 설정한 캡슐과 동일한 사이즈의 캡슐은 다시 설정한 추출량으로 추출이 됩니다.

- i** 설정된 추출량은 각 캡슐 사이즈에 따라 다르게 적용됩니다. 커피 추출량은 20 ml 부터 535 ml 까지 설정이 가능합니다

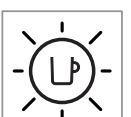
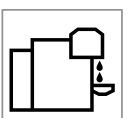
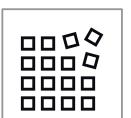
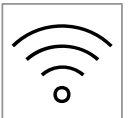

주의: 머신이 작동 중일 때는 절대로 머신의 헤드를 열지 말고 머신 버튼이 깜박이지 않고 흰색으로 점등된 상태로 바뀔 때까지 기다리십시오. 추출을 중단하고 싶다면 커피 버튼을 누르고 머신이 멈출 때까지 기다렸다가 헤드를 여십시오.

중요: 추출량을 설정하게 되면, 커피 종류에 관계 없이 동일한 사이즈의 캡슐을 추출할 때마다 설정한 추출량이 추출됩니다. 기본으로 설정된 추출량으로 되돌리려면, 공장 출하 설정값으로 초기화 부분을 참조하십시오.

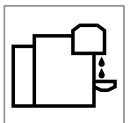
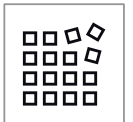

청소하기

머신을 장시간 사용하지 않았거나 머신 헤드 부분에 커피 찌꺼기가 남을 경우 1개월에 한 번씩 청소하십시오.

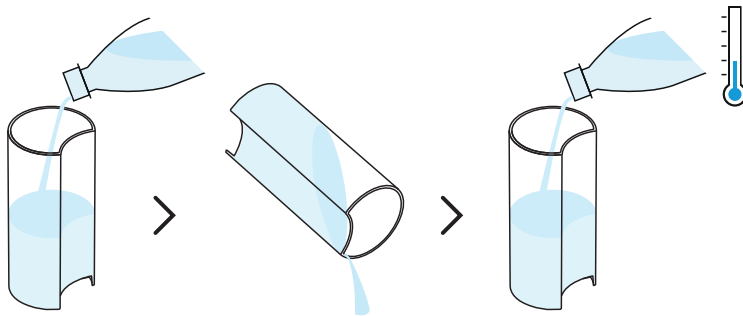

1 물통과 뚜껑을 깨끗한 물로 헹구고 깨끗한 음용수로 물통을 채웁니다.

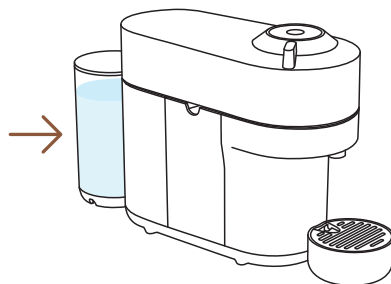

2 물통을 머신에 올바르게 장착합니다.

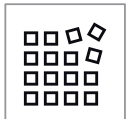

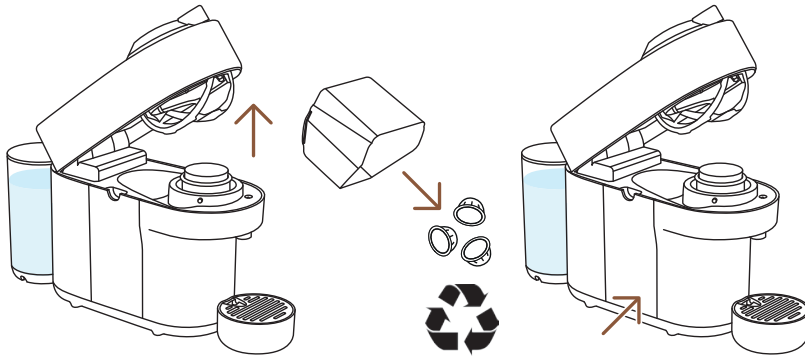

- 3** 머신의 전원이 켜진 상태로, 레버를 오른쪽으로 끝까지 돌려 머신 헤드를 열고 사용한 캡슐을 배출합니다. 캡슐 컨테이너와 드립 트레이를 비우고 헹군 후 다시 머신에 장착합니다. 네스프레소 캡슐을 재활용 하십시오.*

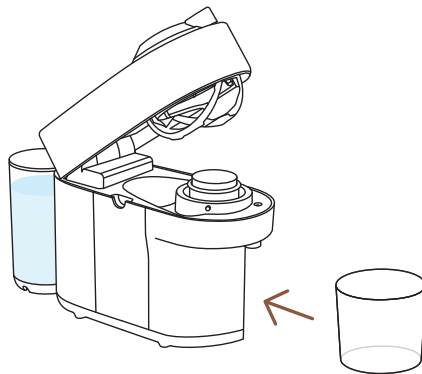

- 4** 컵 받침을 제거하고 커피 추출구 아래에 1 L 이상의 빈 용기를 놓습니다.

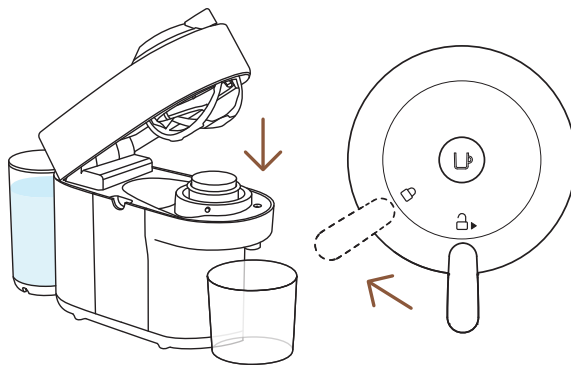

- 5** 머신 헤드를 닫고 잠금 위치까지 레버를 돌립니다. 헹굼 과정을 시작하기 전에 헤드에 캡슐이 없는지 확인합니다.

* THIS IS **NESPRESSO**. THIS IS RECYCLABLE. 캡슐 재활용에 관한 자세한 정보는 공식 **홈페이지**에서 확인하실 수 있습니다
www.nespresso.com

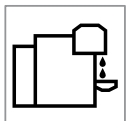

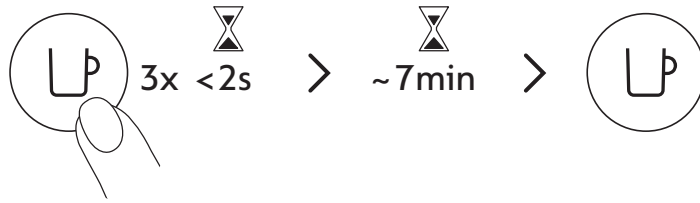

6 버튼을 2초 이내에 3번 누릅니다. 행굼 과정 진행 중 주황색 불빛이 깜빡이며, 자동으로 완료되도록 기다립니다.

i 행굼 과정을 시작하고 2분 이내에 커피 추출구로 뜨거운 물이 나오기 시작합니다. 행굼 과정은 최대 7분이 소요되며, 모든 과정이 완료되면 자동으로 종료됩니다. 행굼 중에 언제든지 버튼을 눌러 중단할 수 있습니다.

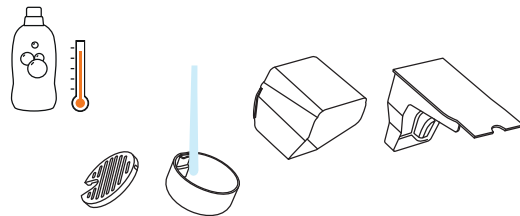

7 캡슐 컨테이너, 컵 받침 및 드립 트레이를 따뜻한 물과 중성 세척제로 세척합니다.

주의: 강한 세제나 세척제는 절대 사용하지 마십시오. 절대 머신을 식기세척기에 넣지 마십시오. 절대 제품 또는 제품의 일부를 물이나 다른 액체에 담그지 마십시오.

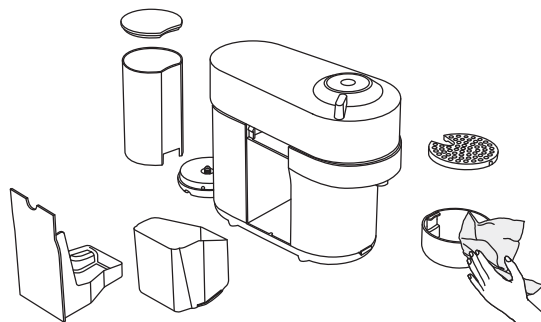

8 머신을 깨끗한 천으로 닦고 말립니다.

주의: 커피 추출구를 깨끗하고 젖은 천으로 매일 닦습니다. 머신을 청소할 때는 항상 깨끗하고 부드러운 천을 사용하십시오.

중요: 커피 추출 후 혹은 청소 모드 진행 후에 머신 헤드 안쪽에 물이 남을 수 있습니다. 깨끗한 마른 천으로 닦아주세요.

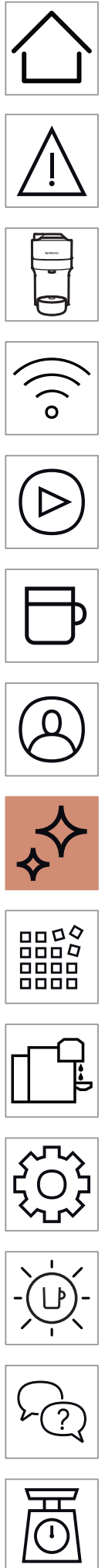

디스케일링

디스케일링을 적절히 수행하면, 머신을 사용하는 동안 제대로 작동하고 처음 사용한 날과 같은 커피 경험을 할 수 있습니다. 흰색 불빛이 켜지기 전 주황색 불빛이 3번 깜빡이면, 디스케일링이 필요하다는 알림입니다.



i 디스케일링은 최대 20분이 소요되며 도중에 중단할 경우 처음부터 다시 진행해야 합니다.

중요: 디스케일링 과정을 시작하기 전에 설명서와 안전 수칙을 주의 깊게 읽으십시오.

필요한 도구:

- 디스케일링 키트는 www.nespresso.com에서 구매 가능합니다. (한국 네스프레소에서는 디스케일링 키트를 판매하지 않습니다. 깨끗한 물로만 디스케일링을 진행하여 주십시오.)
- 1 L 이상의 빈 용기

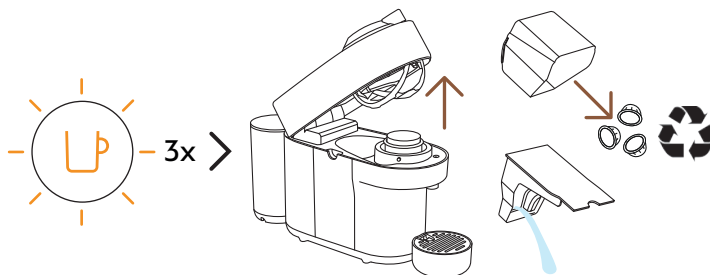

1 버튼이 주황색으로 3번 깜빡이는 경우: 레버를 오른쪽으로 끝까지 돌려 머신 헤드를 열어 사용한 캡슐을 배출합니다. 캡슐 컨테이너와 드립 트레이를 비우고 다시 머신에 장착합니다. 네스프레소 캡슐을 재활용 하십시오.*

* THIS IS **NESPRESSO**. THIS IS RECYCLABLE. 캡슐 재활용에 관한 자세한 정보는 공식 **홈페이지**에서 확인하실 수 있습니다
www.nespresso.com

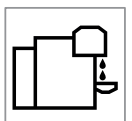
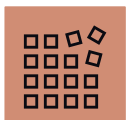

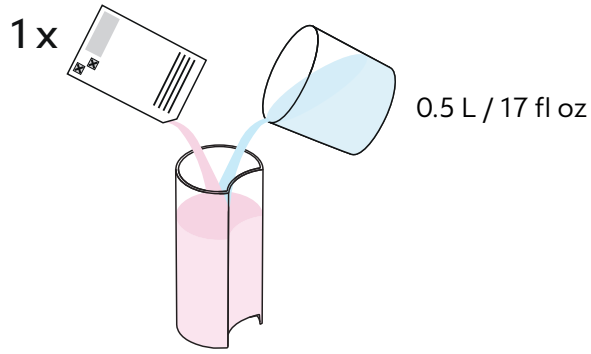

- 2** 물통에 네스프레소 디스케일링 용액 1개와 최소 0.5 L 이상의 물을 넣습니다. (**한국 네스프레소**에서는 디스케일링 키트를 판매하지 않습니다. 깨끗한 물로만 디스케일링을 진행하여 주십시오.)

주의: 디스케일링 용액은 유해할 수 있습니다. 눈이나 피부에 닿지 않도록 주의하여 주십시오.

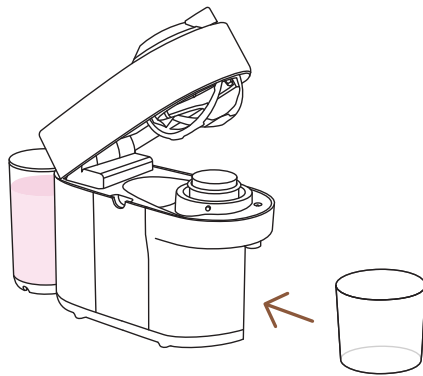

- 3** 컵 받침을 제거하고 커피 추출구 아래에 1 L 이상의 빈 용기를 놓습니다.

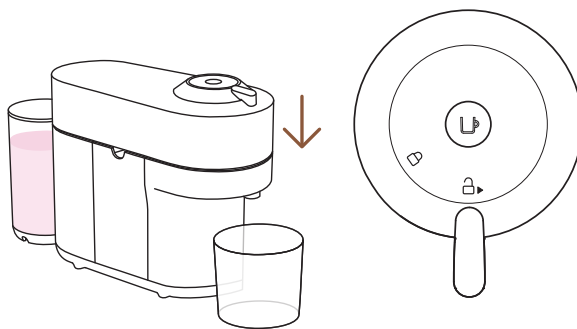

- 4** 머신의 전원이 켜진 상태로, 머신 헤드를 닫고 레버는 잠금 해제 위치에 그대로 둡니다.

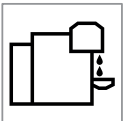
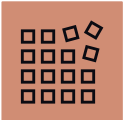
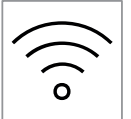

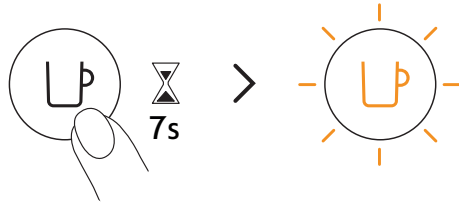

- 5** 버튼을 7초 이상 또는 불빛이 꺼질 때까지 누릅니다. 버튼이 주황색으로 빠르게 깜빡이기 시작합니다.

주의: 머신이 디스케일링 모드에 진입되고 45초간 아무런 조작이 없을 경우 머신은 다시 추출 준비 단계로 돌아갑니다.

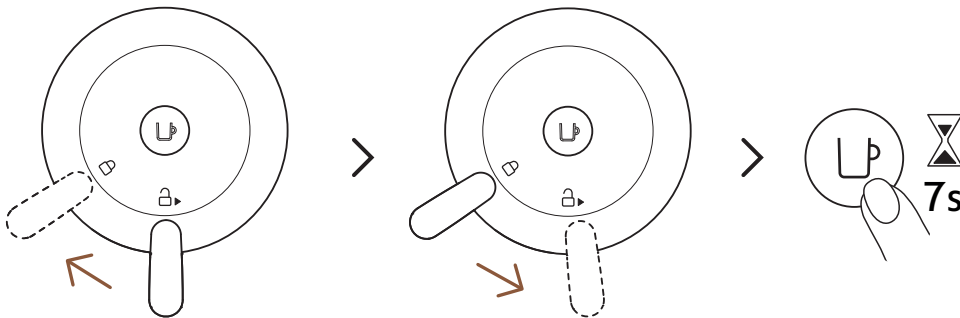

- 6** 레버를 왼쪽으로 끝까지 돌려 머신 헤드를 잠그고, 다시 레버를 오른쪽으로 끝까지 돌립니다. 다시 버튼을 7초 이상 누릅니다. 불빛이 꺼졌다가 주황색으로 빠르게 깜빡이기 시작합니다.

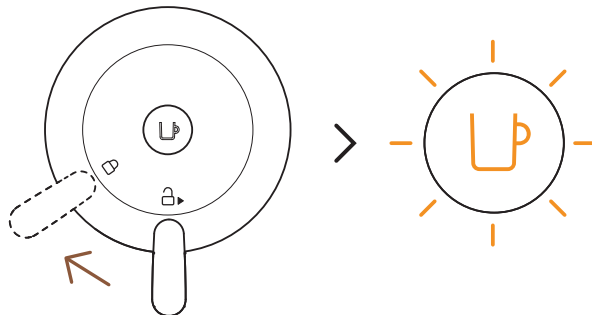

- 7** 디스케일링 모드에 진입하려면, 레버를 왼쪽으로 끝까지 돌려 머신 헤드를 잠급니다. 불빛이 계속 주황색으로 빠르게 깜빡이면 디스케일링 모드에 진입한 것을 나타냅니다.

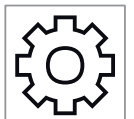
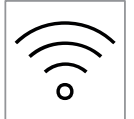

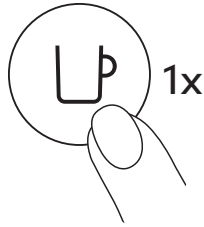

8 버튼을 한번 눌러 디스케일링 과정을 시작합니다. 디스케일링 과정 동안 버튼이 주황색으로 깜빡입니다.

i 첫 번째 디스케일링 과정이 완료되면 머신이 자동으로 멈춥니다.

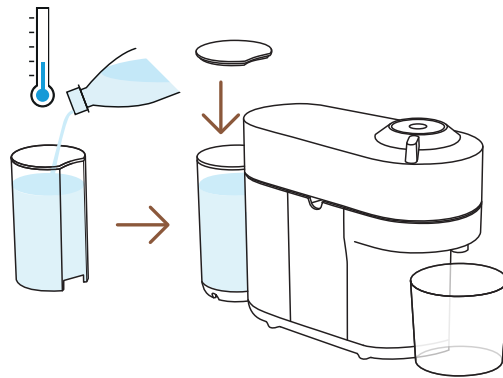

9 첫 번째 디스케일링 과정이 끝나면, 헹굼 과정을 진행해야 합니다. 물통과 드립 트레이를 깨끗하게 헹굽니다. 깨끗한 음용수로 물통을 채우고 물통을 머신에 올바르게 장착합니다. 커피 추출구 아래의 용기를 비우고 다시 놓습니다.

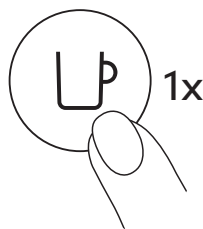

10 버튼을 한번 눌러 헹굼 과정을 시작합니다. 버튼이 깜빡이는 것을 멈추면, 디스케일링 과정이 완료된 것입니다.

i 디스케일링 과정이 완료되면, 머신은 자동으로 작동을 멈춥니다.

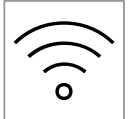

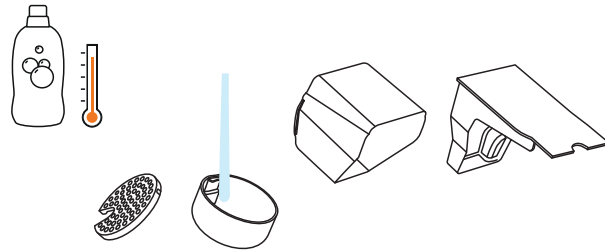

11 캡슐 컨테이너, 컵 받침 및 드립 트레이를 따뜻한 물과 중성 세척제로 세척합니다.

주의: 강한 세제나 세척제는 절대 사용하지 마십시오. 절대 머신을 식기세척기에 넣지 마십시오. 절대 제품 또는 제품의 일부를 물이나 다른 액체에 담그지 마십시오.

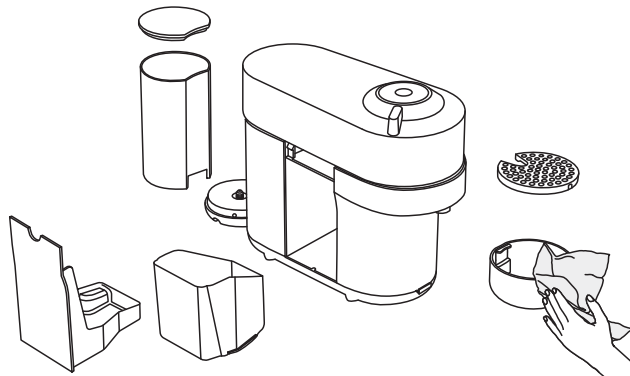

12 머신을 깨끗한 천으로 닦고 말립니다. 머신을 사용하기 전에 10분간 말립니다.

중요: 청소 과정 중 머신 헤드 안쪽에 물이 남을 수 있습니다. 깨끗하고 마른 천으로 보이는 부분을 닦아주세요.

중요: 버췌오 팝 머신은 최소 30회 이상 커피를 추출한 후에 디스케일링 모드를 진행할 수 있습니다. 추출하지 않은 새 머신은 디스케일링을 진행할 수 없습니다.

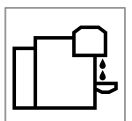

머신 내부의 물 비우기

머신 내부의 물 비우기는 장기간 사용 계획이 없는 경우, 동파 방지를 위해 또는 수리 보내기 전에 해야하는 과정입니다.

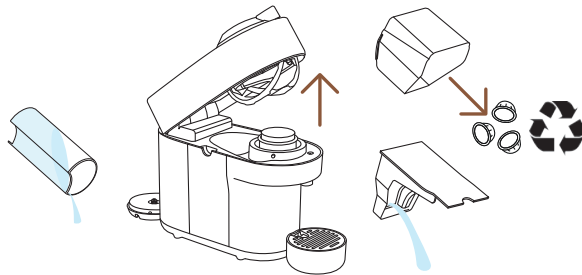

- 1** 물통을 비우고 머신 헤드를 열고 사용한 캡슐을 배출합니다. 캡슐 컨테이너와 드립 트레이를 비웁니다. 네스프레소 캡슐을 재활용 하십시오.*

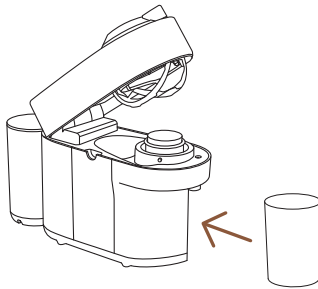

- 2** 다시 부품들을 머신에 장착하고, 컵 받침을 제거합니다. 커피 추출구 아래에 0.5 L 이상의 빈 용기를 놓습니다.

* THIS IS **NESPRESSO**. THIS IS RECYCLABLE. 캡슐 재활용에 관한 자세한 정보는 공식 **홈페이지**에서 확인하실 수 있습니다
www.nespresso.com



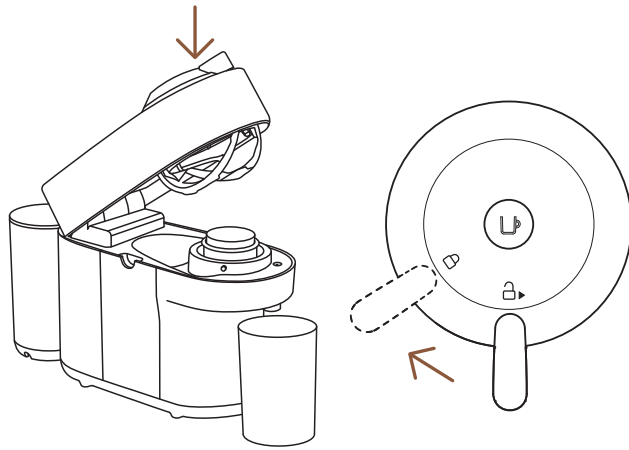

3 머신의 전원 플러그를 연결하고 전원을 켭니다. 레버를 왼쪽으로 끝까지 돌려 머신 헤드를 잠급니다.

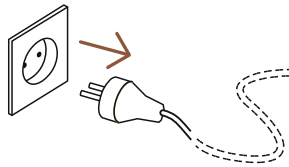

4 머신의 전원 플러그를 뽑습니다.

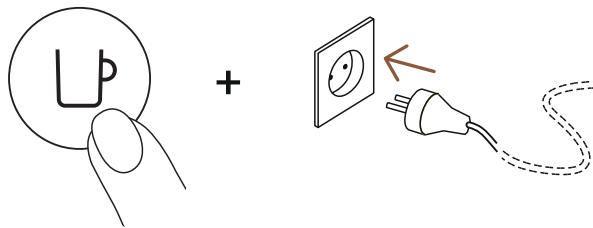

5 버튼을 누른 상태로 플러그를 연결합니다

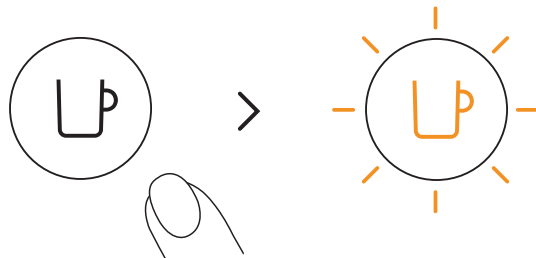

6 버튼에서 손을 땁니다. 비우기 과정이 시작되고 주황색 불빛이 깜빡입니다.

i 비우기 과정은 약 30초가 소요됩니다. 모든 과정이 완료되면 자동으로 머신의 전원이 꺼집니다.



공장 출하 설정값으로 초기화

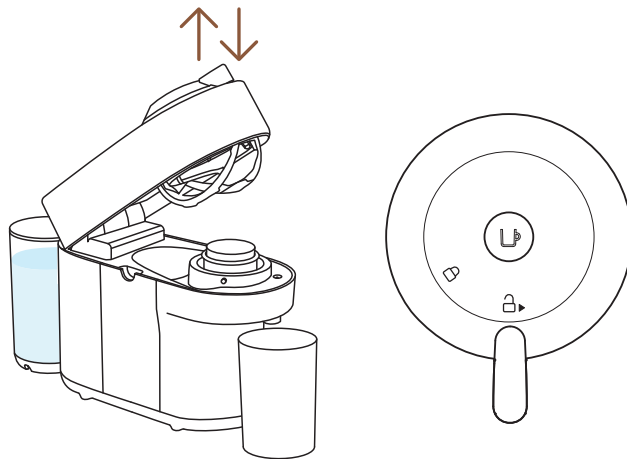

- 1** 머신의 전원 플러그를 연결하고, 머신 헤드를 열었다가 닫은 뒤 레버는 잠금 해제 위치에 그대로 둡니다.

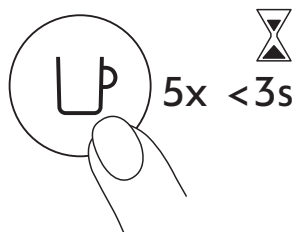

- 2** 버튼을 3초 이내에 5번 누릅니다. 공장 출하 설정값으로 초기화가 완료됩니다.

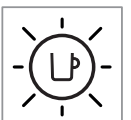
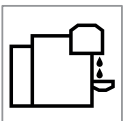
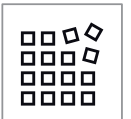
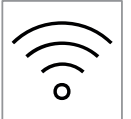

버튼 불빛 깜빡임 요약

버추오 팝 머신의 불빛 깜박임에 대해 더 알아보고 싶다면,
다음 비디오를 확인하십시오:

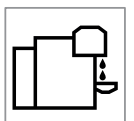
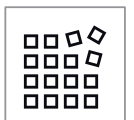

문제 해결

버튼에 불빛이 들어오지 않습니다.

커피와 물이 추출되지 않습니다.

커피가 충분히 뜨겁지 않습니다.

누수가 발생하거나 커피 추출이 원활하지 않습니다.

머신의 전원이 꺼졌습니다.

컵에 많은 양의 커피 가루가 나옵니다.

머신이 작동하지 않고 불빛이 켜져 있습니다. 만약 계속 깜빡이는 경우, 다음 해결 방법을 참조하십시오.

머신이 작동하지 않고 불빛이 켜졌다 꺼짐을 반복합니다. 1번 켜지고 1번 꺼짐.

- 머신이 자동으로 꺼졌을 경우; 버튼을 누르거나 레버를 “잠금 해제” 합니다.
- 전원 플러그, 전압, 퓨즈를 확인합니다.
- 물통에 물이 채워져 있는지 확인합니다.
- 새 캡슐이 제대로 장착되어 있고, 헤드가 정상적으로 닫혀 있는 상태에서 레버가 끝까지 잠겨있는지 확인 후 버튼을 눌러 재시도 합니다.
- 필요 시 디스케일링을 진행합니다.
- 머신의 헤드를 열어 캡슐을 배출한 후, 청소하기 부분을 참고하여 청소를 진행합니다.
- 따뜻한 물로 컵을 데운 후 사용합니다.
- 필요 시 디스케일링을 진행합니다.
- 물통이 제대로 장착되어 있는지 확인합니다.
- 필요 시 디스케일링을 진행 합니다.
- 에너지 절전을 위해 2분 동안 머신을 사용하지 않으면 자동으로 전원이 꺼집니다.
- 머신을 사용하지 않을 경우 버튼을 3초간 눌러 머신의 전원을 끌 수 있습니다,
- 청소 과정을 2회 진행합니다.
- 청소하기 부분을 참고하십시오.
- 머신의 레버가 제대로 잠겨 있는지 확인합니다.
- 새 캡슐이 제대로 장착되어 있고, 헤드가 정상적으로 닫혀 있는 상태로 레버가 끝까지 잠겨있는지 확인 후 버튼을 눌러 재시도 합니다.
- 만약 청소, 디스케일링, 비우기 모드를 할 경우에는 사용한 캡슐이 머신 내부에 남아 있는지 확인 한 후 헤드를 잠근 후, 재실행합니다.
- 물통에 물을 채운 뒤 버튼을 누릅니다.
- 머신의 헤드가 제대로 잠겨 있는지 확인합니다.

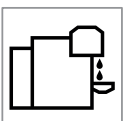
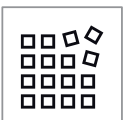

머신이 작동 중에 불빛이 깜빡입니다.

- 만약 커피가 정상적으로 나오는 상황이면, 머신이 정상적으로 작동함을 나타내는 불빛입니다.
- 만약 물이 나오는 상태이면 청소, 디스케일링 혹은 물 비우기를 실행하는 중입니다. 사용 설명서의 해당 부분을 참고합니다.
- 버튼을 3초간 눌러 머신의 전원을 끈 후, 약 20분 정도 머신이 냉각되길 기다립니다. 다시 버튼을 눌러 전원을 켵니다.

불빛이 깜빡이며 머신이 작동하지 않습니다.

- 바코드를 읽고 프리 인퓨전 과정을 진행하기 때문에 커피가 추출되기까지 약간의 시간이 소요됩니다.
- 새 캡슐이 제대로 장착되어 있고, 헤드가 정상적으로 닫혀 있는 상태로 레버가 끝까지 잠겨있는지 확인 후 버튼을 눌러 재시도 합니다.
- 물통에 물을 채운 뒤 버튼을 누릅니다.
- 버튼을 3초간 눌러 머신의 전원을 끈 후, 약 20분 정도 머신이 냉각되길 기다립니다. 다시 버튼을 눌러 전원을 켵니다.

버튼의 불빛이 두번 깜빡이고 한번 멈추며 머신이 작동하지 않습니다.

- 정상적인 커피 추출 중 일 경우:
 - 1) 레버를 잠금 해제하여 헤드를 연 후 찌그러지지 않은 캡슐이 정상적인 위치에 놓여있는지 확인합니다.
 - 2) 레버가 “잠금” 위치에 있는지 확인합니다.
 - 3) 물통에 물이 채워져 있는지 확인합니다.
- 디스케일링, 비우기, 청소하기 중
 - 1) 머신 내부에 캡슐이 배출 되었는지 확인합니다.
 - 2) 레버가 “잠금” 위치에 있는지 확인합니다.
- 추출량 설정 중
 - 1) 캡슐이 올바른 위치에 잘 투입되었는지 확인합니다.
 - 2) 추출량 설정 페이지를 참고합니다.

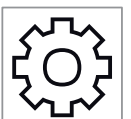
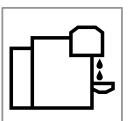
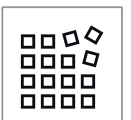
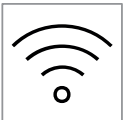

**불빛이 3번 깜빡인 후
켜집니다.**

- 만약 문제가 지속되면:
 - 1) 레버를 잠금 해제하고 머신의 헤드를 엽니다.
 - 2) (필요 시) 캡슐을 교체합니다.
 - 3) 콘센트에서 전원 플러그를 분리한 후 약 10초 뒤에 다시 연결합니다.
 - 4) 머신의 헤드를 닫고 버튼을 눌러 전원을 켜고 추출을 위해 다시 버튼을 누릅니다.
 만약 문제가 지속되면 **네스프레소 클럽**으로 연락하십시오.

- 디스케일링이 필요함: 알람이 나타난 이후로 디스케일링을 진행하지 않으면 머신 성능에 영향을 줄 수 있습니다. 즉시 디스케일링을 진행하십시오.

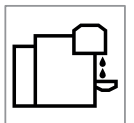
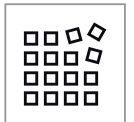

제품 사양

전력	~220-240 V, 50-60 Hz, 1300-1500 W KR: 220 V, 60 Hz, 1300 W US, CA: 120 V, 60 Hz, 1500 W MX: 127 V~, 60 Hz, 1380 W
주파수	2.402-2.480 GHz
전파 송신 출력 강도 (EIRP)	블루투스 최대 전파 송신 출력 강도 4 dBm / Wi-Fi 최대 전파 송신 출력 강도 <20 dMm
대기전력	0.39 W/h
에너지 절약 모드	자동 꺼짐 : 2분
예열 시간	30초(헤드가 닫히고 잠긴 상태로)
높이 조절이 가능한 컵 받침	탈착이 가능한 단일 위치
머신의 케이블 길이	75 cm / 30 in
크기 (폭 x 깊이 x 높이)	13.6 x 42.6 x 25 cm / 5.3 x 16.7 x 9.8 in
무게	3.5 kg / 7.72 lbs
물통 용량	600 ml / 20 fl oz
캡슐 컨테이너 용량	에스프레소 8 캡슐 또는 머그 5 캡슐

제품 모델명

Nespresso	Breville	Delonghi
GCV2, GDV2	BNV120, BNV150	ENV90
Krups	Magimix	
XN9201, XN9204, XN9205, XN9211	M800	

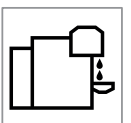
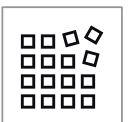
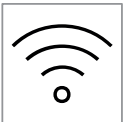

點擊並選擇您的語言

HK



安全資訊



總覽



連接



首次使用



調製咖啡



調節咖啡杯量



清洗



除磷



清空系統



回復原廠設定



閃燈提示



問題解答



規格

安全資訊

注意: 使用咖啡機前請仔細閱讀安全指引單張, 以避免發生任何損傷及損壞。

棄置與環保

本咖啡機符合 EU Directive 2012/19/EC 要求。所有包裝物料和產品本身均有採用循環再造物料。您的咖啡機包含有有價值而可回收或循環再造的物料。只要將廢棄物分開處理, 即可將用價值的原材料循環再造。請將本產品棄置於環保收集站。您可透過本地的環保機構查詢有關詳情。

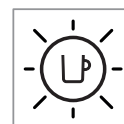
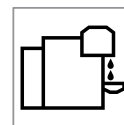
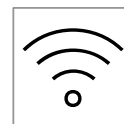

總覽

咖啡機概覽

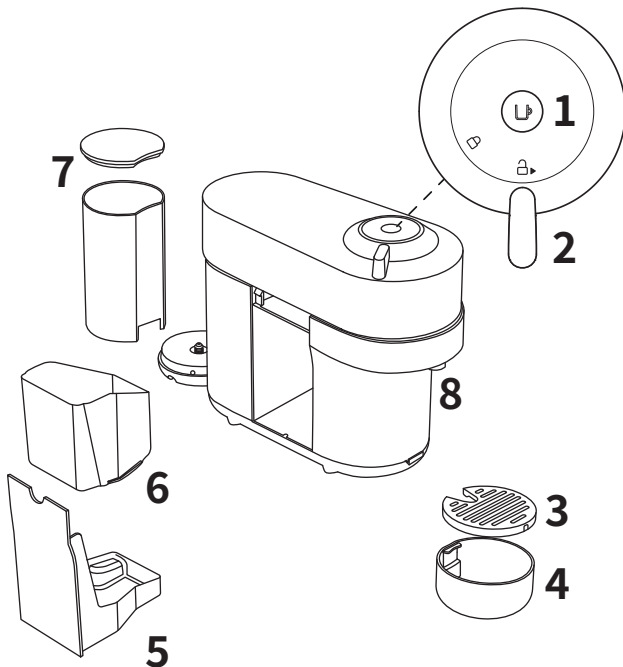

- 1 開／關及咖啡按鈕
- 2 鎖定／解鎖槓桿
- 3 滴水柵格
- 4 可調節杯架
- 5 滴水盤
- 6 粉囊容器
- 7 水箱及蓋
- 8 咖啡出口

包裝內容



- 1 咖啡機
- 2 **Nespresso** 咖啡粉囊套裝
- 3 **Nespresso** 啟動簡冊
- 4 安全預防指引
- 5 快速入門指南
- 6 保用證

4 + 5 + 6

i 開箱: 由於包裝中使用了循環再造物料，因此機器表面可能會存在一些灰塵。這並沒有危險，只需用軟紙巾清潔即可。

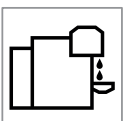
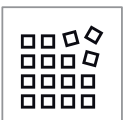

開 / 關

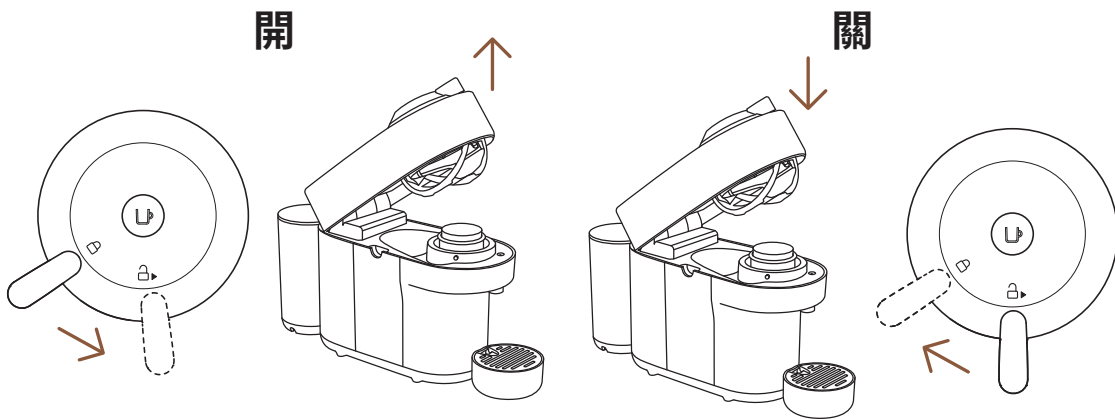

注意:為正確使用咖啡機，請勿於咖啡萃取時，打開機頭。請待咖啡按鈕顯示白燈，再打開機頭。如欲提早停止萃取，請按咖啡按鈕，等待咖啡機停止運作，再打開機頭。

VERTUO 系統

粉囊兼容性



配件兼容性



請瀏覽 www.nespresso.com，探索完整的配件系列。

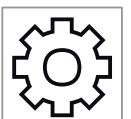
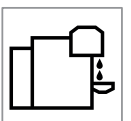
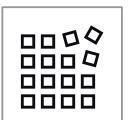

開 / 關

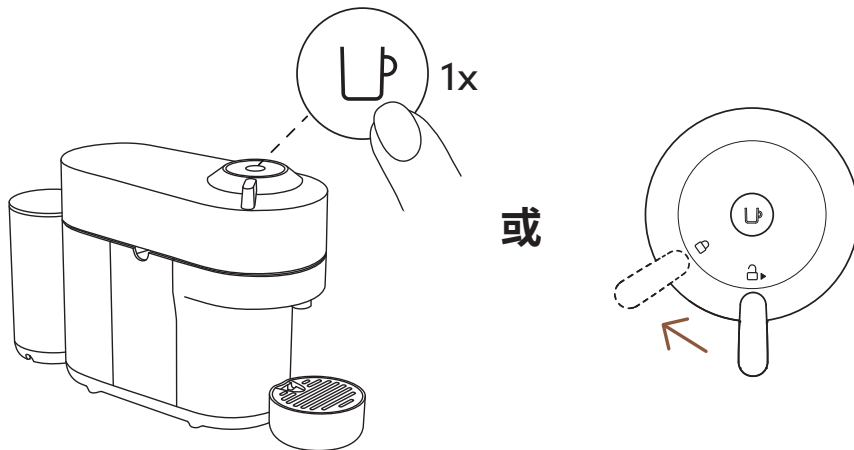

開

咖啡機連接電源後，按下按鈕一次或將槓桿推至鎖定位置（機頭關閉），即可啓動機器。

i 預熱時，指示燈會閃爍大約30秒。當指示燈穩定，代表咖啡機已準備就緒。

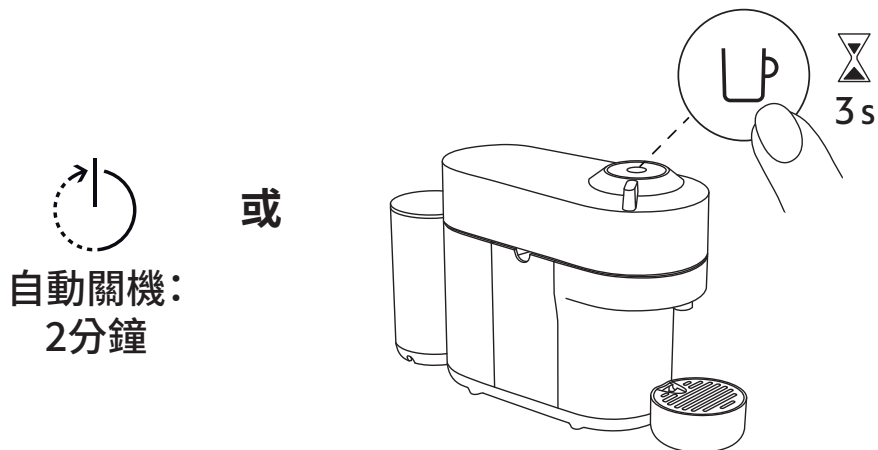

關

為了節省能源，咖啡機閒置2分鐘後會自動關機。

i 長按按鈕3秒，咖啡機即可手動關機（非使用中）。

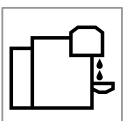
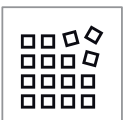
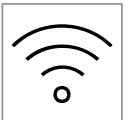

連接

為什麼需連接 VERTUO POP

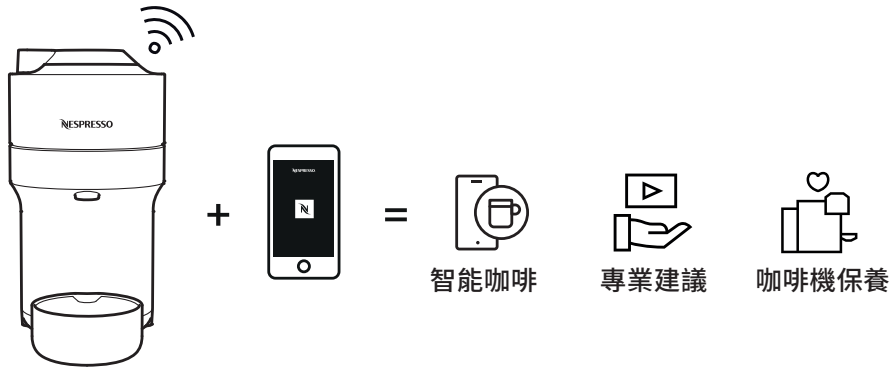

連接VERTUO POP 咖啡機的好處

- **智能咖啡:** 只需一步就能擁有Nespresso嶄新的咖啡創意，時常保持更新和技術。
- **專業建議:** 透過手機，便可取得支援服務和教學影片，伴隨您的咖啡之旅。
- **咖啡機保養:** 即時接收關於如何及何時維護您的咖啡機的通知，並提供簡單易明的步驟指南，包括除磷、沖洗、清潔等。

如何連接您的VERTUO POP ?

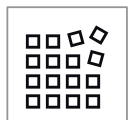
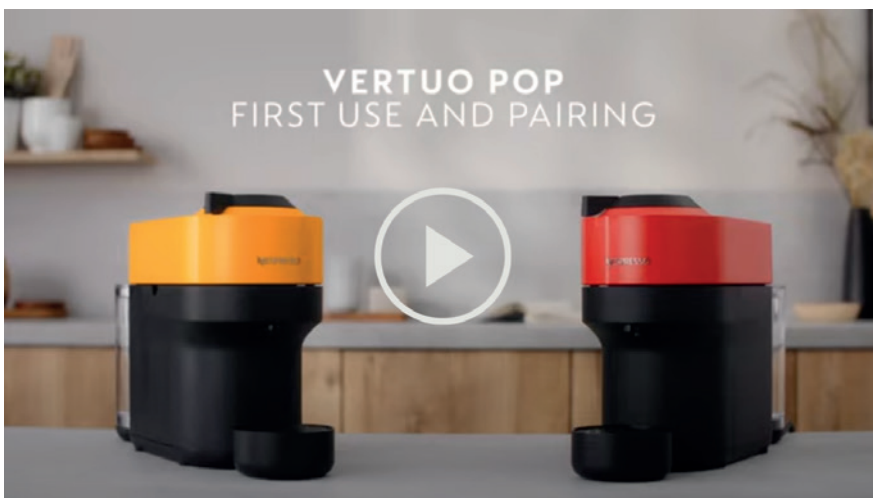



1 下載或更新 **Nespresso** 手機應用程式。在您的手機或平板電腦上啟動 **Nespresso App**。點按屏幕右上角的機器圖示。

注意: 為了達到最佳效能和無縫體驗，我們建議將您的裝置連接至Wi-Fi路由器，而非使用手機的熱點功能。

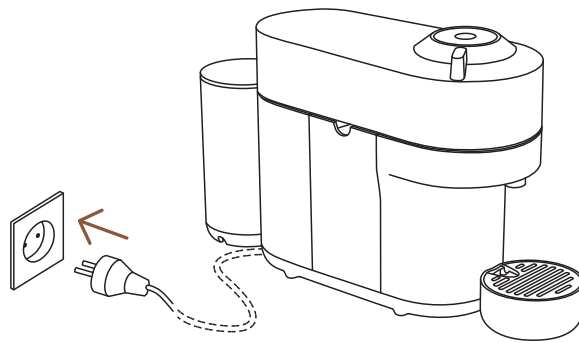

2 連接電源。



3 跟隨 **Nespresso** 手機應用程式的指引。

注意: 請先閱讀安全注意事項，以避免致命的電擊和火災風險。插上電源時，請確保接地線的連接性。

* App Store®是 Apple Inc.在美國及其他國家和地區註冊的商標。
 ** Google Play 和 Google Play 標誌是 Google LLC. 的商標。

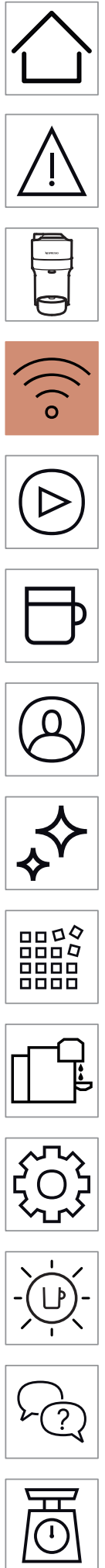

停用藍牙及無線網絡功能

此咖啡機附有連接功能，在原廠設定下已經開啓。它提供了額外的功能，提升您的咖啡體驗。如要停用連接功能，請按照以下步驟：

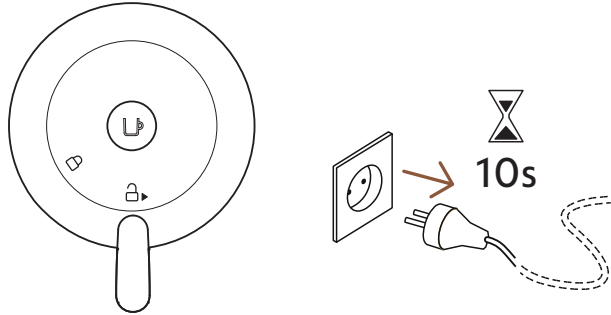

- 1** 在機頭合上及槓桿處於鎖定位置的情況下，將插頭拔除至少10秒。

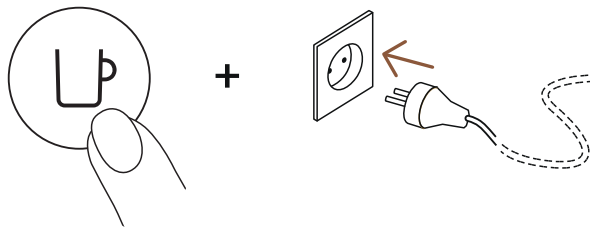

- 2** 長按按鈕並插上電源。
橙色指示燈會閃爍，代表連接功能已經被停用。
- i** 如要再次啓動連接功能，請按照以上相同步驟。按鈕會顯示白燈，確認連接功能已重新啓動。

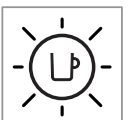
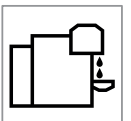
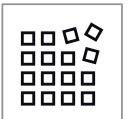

首次使用

首次沖洗

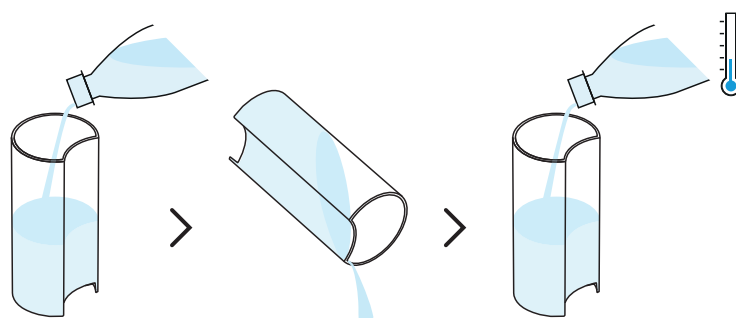

1 在注入新鮮飲用水之前，先沖洗和清潔水箱及蓋。

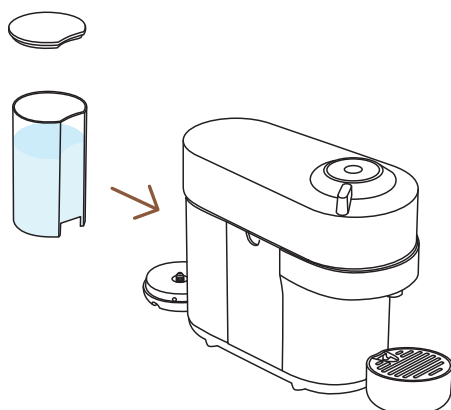

2 蓋好水箱，並放回原位及確保正確安裝。

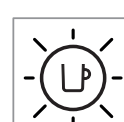
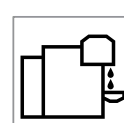
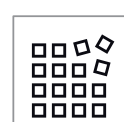
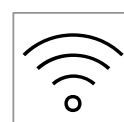

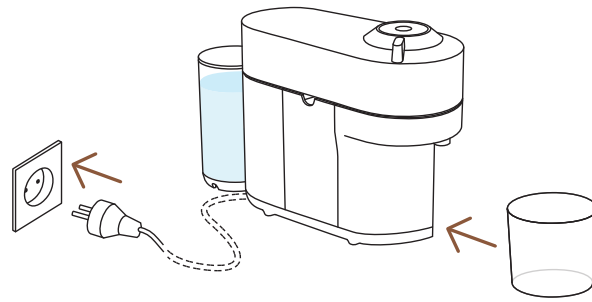

- 3** 在連接電源情況下，移除杯架。在咖啡出口放置一個容量最少1公升的容器。

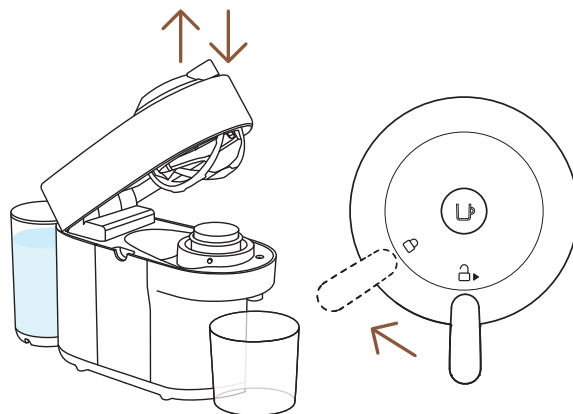

- 4** 打開再合上咖啡機。確保槓桿處於鎖定位置。

- i** 預熱時，指示燈會閃爍。預熱需要大約30秒。當指示燈穩定，代表咖啡機已準備就緒。請確保沒有放置任何咖啡粉囊。

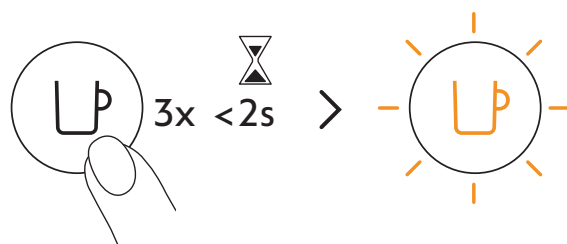

- 5** 2秒內按3次按鈕以開始清洗。橙色指示燈閃爍情況下，請讓清洗程序自動完成。當白色指示燈穩定，代表清洗程序完成。

- i** 清洗程序開始並有水流，需要大約2分鐘。此過程最多可能需要7分鐘。

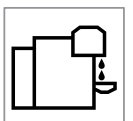
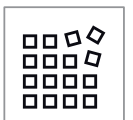

調製咖啡

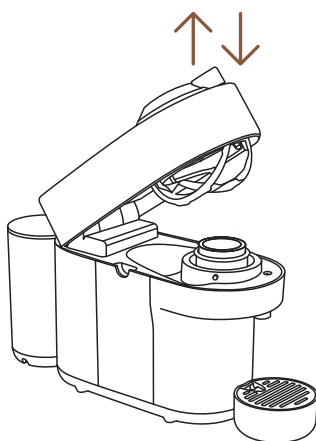

1 打開再合上咖啡機。

i 預熱時，指示燈會閃爍。當指示燈穩定，代表咖啡機已準備就緒。

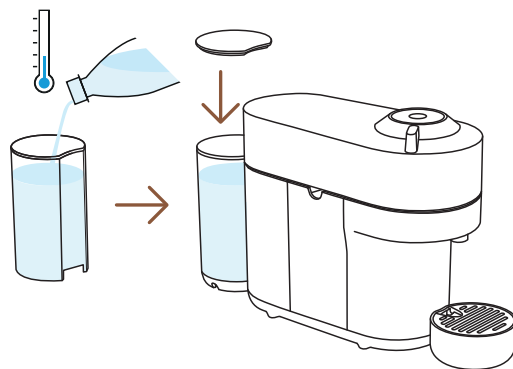

2 在水箱注入新鮮飲用水，並放回原位。

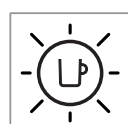
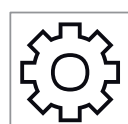
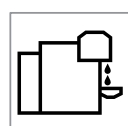
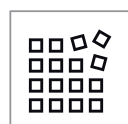
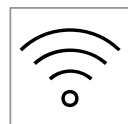

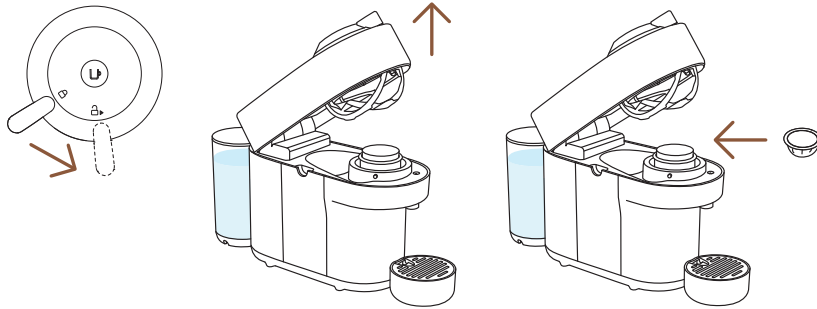

- 3** 解鎖槓桿並打開咖啡機頭。放入一個弧形朝下的Vertuo粉囊。

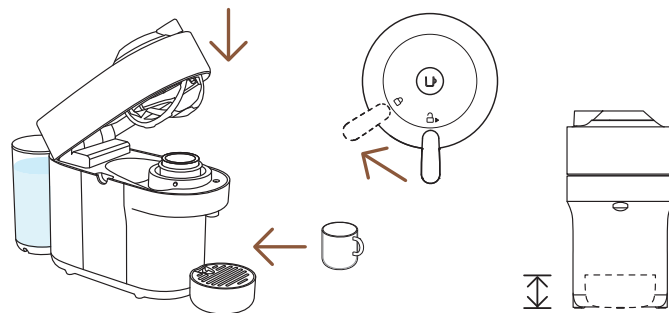

- 4** 合上咖啡機頭並將槓桿推向左邊至鎖定位置。然後放置一個杯。杯架可調節以配合您的杯量。

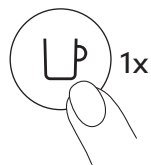

- 5** 按下按鈕，開始萃取咖啡。

注意：為正確使用咖啡機，請勿於咖啡萃取時，打開機頭。請待咖啡按鈕顯示白燈，再打開機頭。如欲提早停止萃取，請按咖啡按鈕，等待咖啡機停止運作，再打開機頭。

- i** 基於條碼掃描技術，咖啡預熱及浸泡需時，咖啡開始流出需要一段時間。咖啡機將自動識別放入的粉囊，並根據 **Nespresso** 咖啡專家定義的咖啡製作參數和杯子容量，以最佳狀態萃取咖啡。

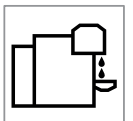

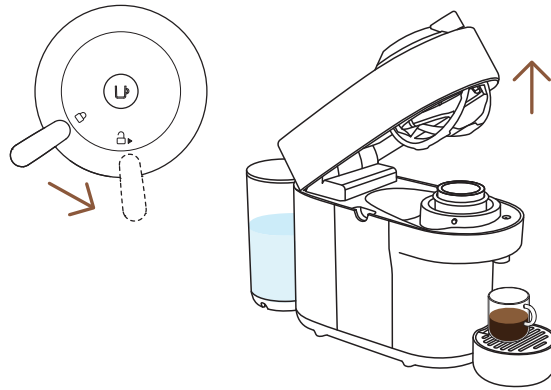

- 6** 咖啡停止萃取時，將槓桿推向右邊至解鎖位置以打開機頭。咖啡粉囊會自動退出。請享用您的咖啡。

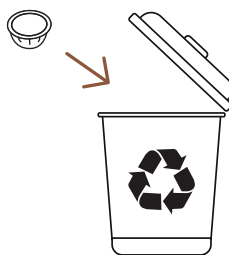

- 7** 請回收您的**Nespresso**粉囊。*

* 這是**Nespresso**。這是可回收的。更多有關回收**Nespresso**粉囊的信息，請瀏覽www.nespresso.com

探索我們的咖啡創作模式



這款**Nespresso**咖啡機提供了一個特別功能，讓您可以濃縮咖啡萃取杯量，創造出您自己的獨特配方。

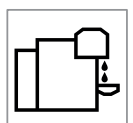

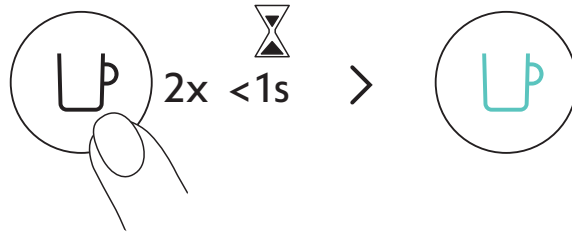

開機狀態下，按下「咖啡」按鈕2次。它將會閃爍著綠松石色，您的咖啡萃取杯量將被濃縮。為了無與倫比的咖啡體驗，依照食譜添加配料（如牛奶、奶精、冰塊等），以完善咖啡味道。

40毫升	80毫升	150毫升	230毫升	355毫升	535毫升
✓	✓	✓	✓	✗	✗
25毫升	40毫升	40毫升	80毫升		

為了充分享受我們Coffee+ 系列帶來的好處，我們建議你僅使用官方推薦的杯量來萃取此系列的咖啡。為求獲得最佳的杯中效果，我們不建議使用此模式來萃取我們的 XL 系列 (Alto Ambrato, Alto Onice)、Cold Brew Style 和 Carafe Pour-Over Style。

注意：可能需要透過 **Nespresso** App 更新您的咖啡機來啟用此模式。



請參閱 www.nespresso.com，了解我們的 Aeroccino 系列，為您的咖啡機升級。

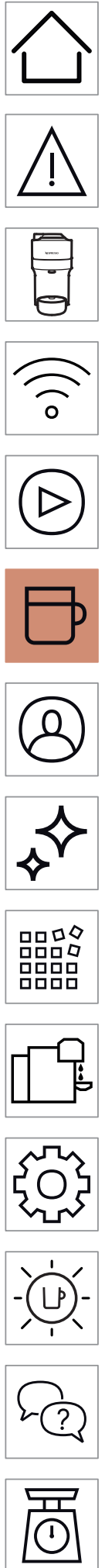

調節咖啡杯量

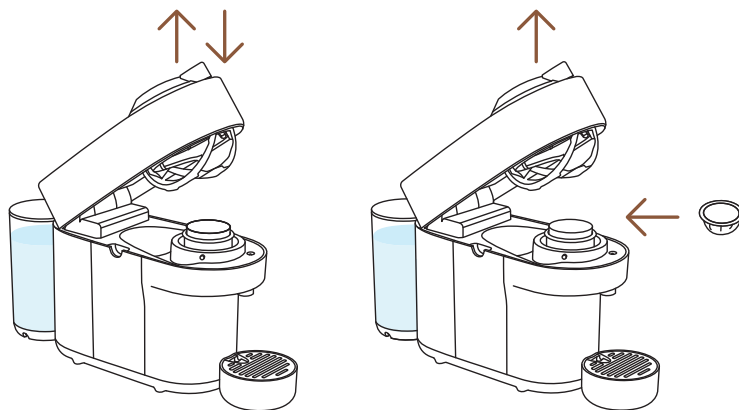

- 1** 打開並合上咖啡機。開機狀態下，打開咖啡機並放入您想設定的咖啡粉囊。

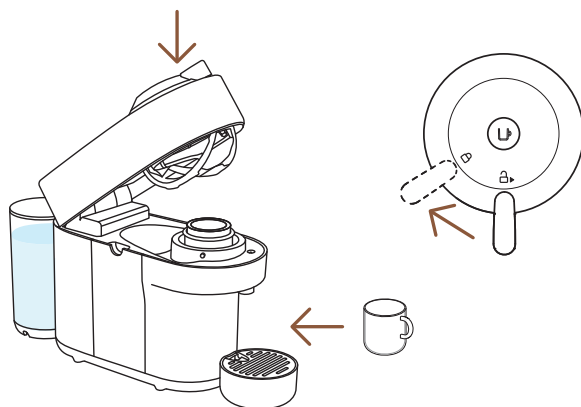

- 2** 合上咖啡機頭並將槓桿推向左邊至鎖定位置。然後放置一個杯。

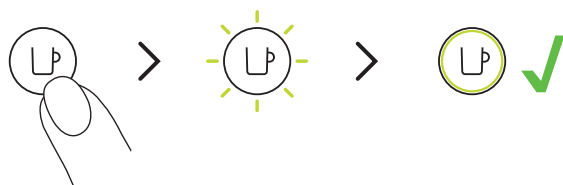

- 3** 長按按鈕，達至理想杯量前幾秒放手。新水量已根據過程中使用的粉囊種類進行設定。

i 此設定根據每種粉囊種類進行。杯量自訂範圍為20毫升至535毫升

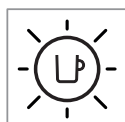
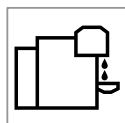
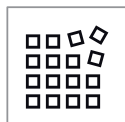
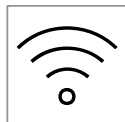

注意: 為正確使用咖啡機，請勿於咖啡萃取時，打開機頭。請待咖啡按鈕顯示白燈，再打開機頭。如欲提早停止萃取，請按咖啡按鈕，等待咖啡機停止運作，再打開機頭。

注意: 當用戶設定杯量後，每當放入該粉囊種類，萃取過程將根據設定杯量停止。如想回復原廠杯量，請參閱“[回復原廠設定](#)”。

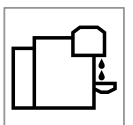
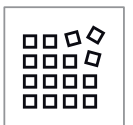

清洗

當您的機頭出現咖啡渣，或長期停用之後，請每月清洗您的咖啡機。

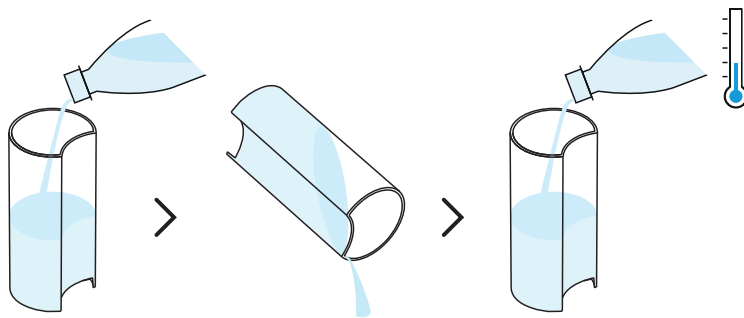

1 在注入新鮮飲用水之前，先沖洗和清潔水箱及蓋。

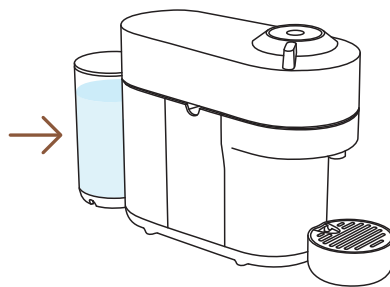

2 將水箱放回原位。

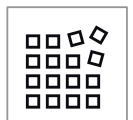

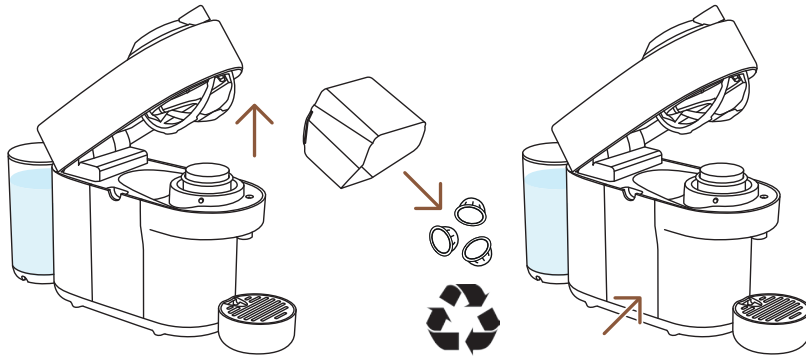

- 3** 開機狀態下，解鎖及打開機頭，讓已使用的粉囊退出。清空及沖洗粉囊棄置格和滴水盤。然後放回原位。請回收您的 **Nespresso** 粉囊。*

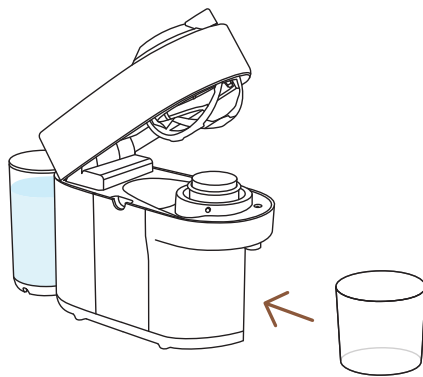

- 4** 移除杯架並在咖啡出口放置一個容量最少1公升的容器。

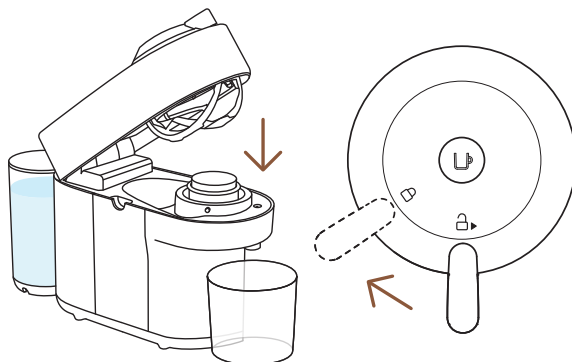

- 5** 合上咖啡機頭並將槓桿推向左邊至鎖定位置。清洗程序開始前，請確保沒有放置任何咖啡粉囊。

* 這是 **Nespresso**。這是可回收的。更多有關回收 **Nespresso** 粉囊的信息，請瀏覽 www.nespresso.com



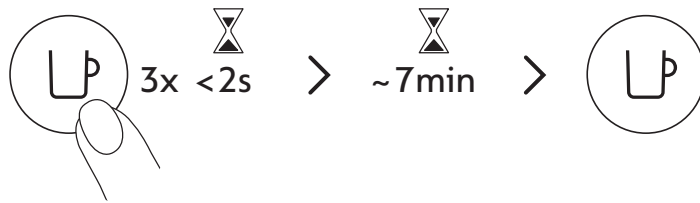

6 2秒內按3次按鈕以開始清洗。橙色指示燈閃爍情況下，請讓清洗程序自動完成。

i 清洗程序開始並有水流，需時少過2分鐘。過程需時7分鐘，並會在完成之後自動停止。過程中可以隨時通過按下按鈕停止。

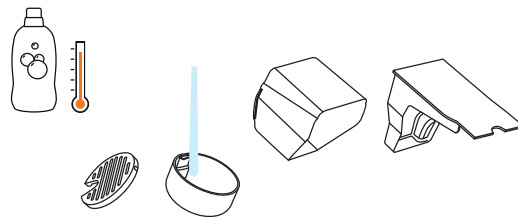

7 用熱水及溫和無味清潔劑沖洗粉囊棄置格、杯架及滴水盤。

注意: 請勿使用強力清潔劑、強力磨砂及溶劑清潔劑。請勿將咖啡機放入洗碗碟機。請勿將咖啡機及其部分浸入水中。

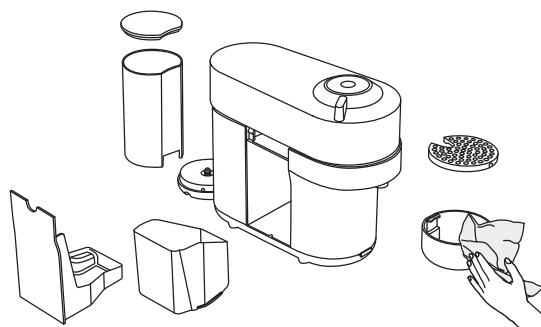

8 用乾淨的毛巾抹乾。

注意: 定期用乾淨的濕布清潔咖啡出口。請務必使用柔軟的抹布清潔咖啡機。

注意: 水可能會積聚在機頂內，請用清潔的乾布抹乾可見的部分。

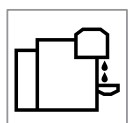

除磷

為您的咖啡機除磷，確保在使用壽命內正常運作，維持無與倫比的咖啡體驗。咖啡機會閃爍3次橙燈，然後白色指示燈持續亮起，以示需要除磷。



i 除磷程序需要大約20分鐘，並不能中斷。

注意：開始除磷前，請仔細閱讀除磷指示。

您需要：

- **Nespresso** 除磷劑，可在www.nespresso.com購買
- 容器(1公升)

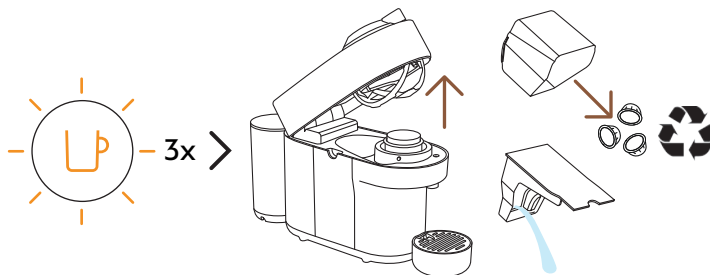

1 橙色指示燈閃爍3次：解鎖並打開機頭，讓已使用的粉囊退出。清空粉囊棄置格及滴水盤，然後放回原位。請回收您的 **Nespresso** 粉囊。*

* 這是 **Nespresso**。這是可回收的。更多有關回收 **Nespresso** 粉囊的信息，請瀏覽 www.nespresso.com

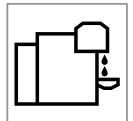

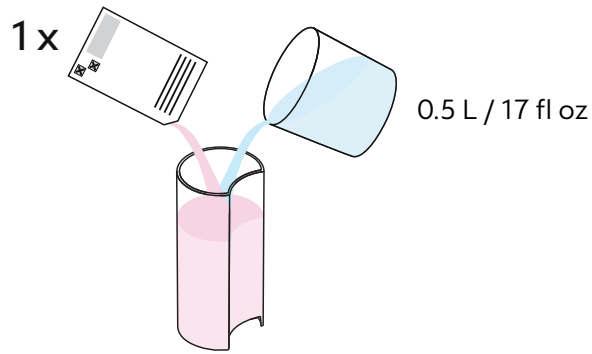

2 在水箱加入0.5公升水，再加入1份除磷劑。

注意：除磷劑可能有害。避免觸及眼睛、皮膚和其他表面。

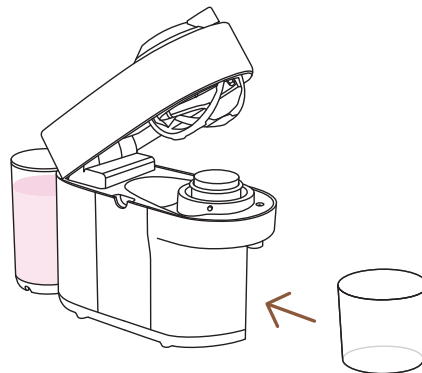

3 移除杯架並在咖啡出口放置一個容量最少1公升的容器。

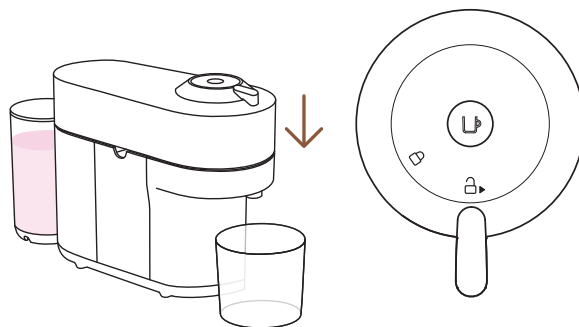

4 在開機情況下，合上機頭，並將槓桿停留在解鎖位置。

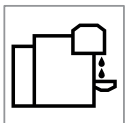

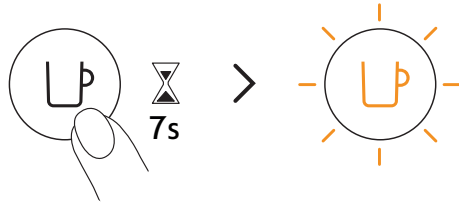

- 5** 長按按鈕最少7秒，或見到指示燈熄掉。按鈕會開始閃爍橙燈。

注意： 您有45秒時間進入除磷模式，否則機器將回到萃取模式。

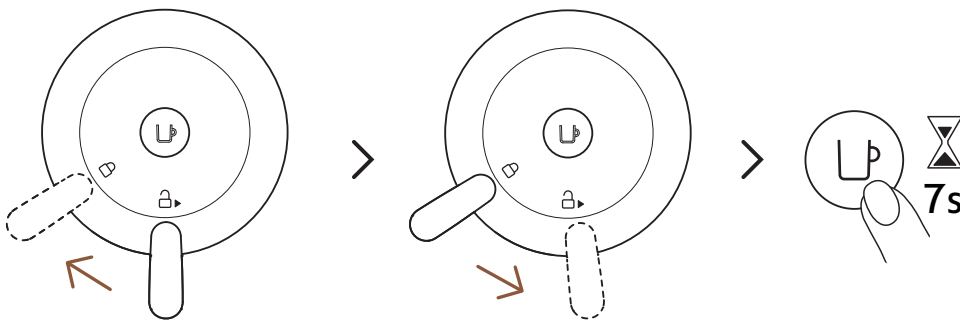

- 6** 將槓桿推向左邊至鎖定位置，鎖上機頭。將槓桿推向右邊至解鎖位置，解鎖機頭。長按按鈕最少7秒或至指示燈熄掉。按鈕會開始快速閃爍橙燈。

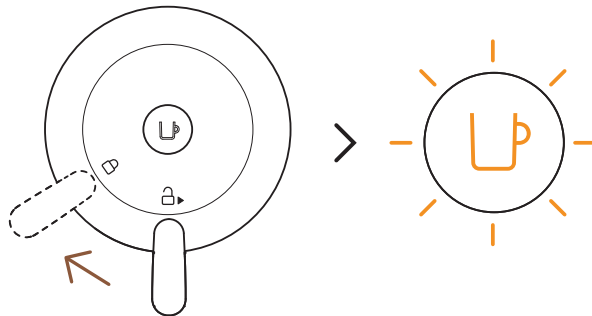

- 7** 如要進入除磷模式，將槓桿推向左邊至鎖定位置。指示燈會快速閃爍橙燈，表示已進入除磷模式。

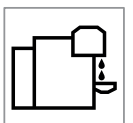
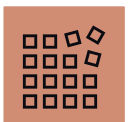

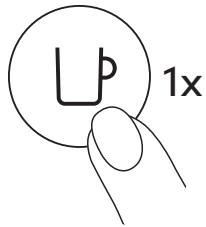

- 8** 按下咖啡按鈕一次，開始除磷程序。過程中，橙色指示燈會持續閃爍。

i 第一階段除磷程序完成後，咖啡機會自動停止運作。

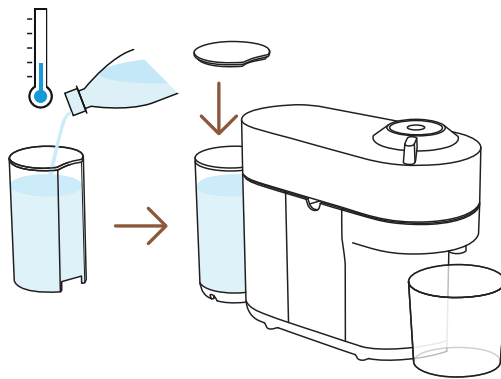

- 9** 除磷程序結束後，需要沖洗機器。徹底沖洗水箱及滴水盤。在水箱注入新鮮飲用水，並放回原位。清空容器，然後放回出口下方。

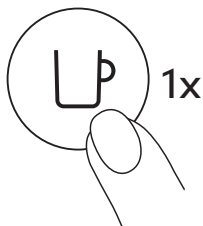

- 10** 按下按鈕開始沖洗咖啡機。當指示燈穩定並停止閃爍，代表除磷程序已經完成。

i 程序完成後，機器會自動停止。

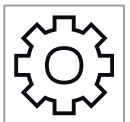

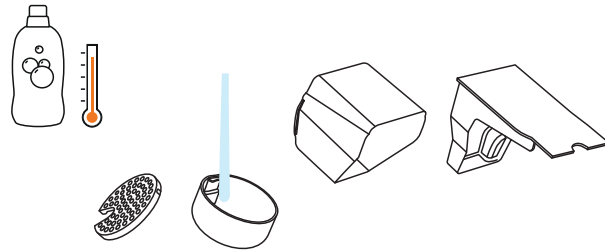

11 用熱水及溫和無味清潔劑沖洗粉囊棄置格、杯架及滴水盤。

注意: 請勿使用強力清潔劑、強力磨砂及溶劑清潔劑。請勿將咖啡機放入洗碗碟機。請勿將咖啡機其部分浸入水中。

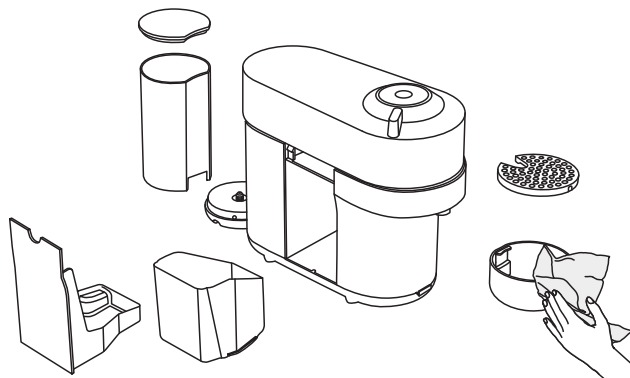

12 用乾淨的毛巾抹乾。使用前，讓咖啡機風乾10分鐘。

注意: 水可能在清潔時積聚在機頂內。如果此情況發生，請用清潔的乾抹布抹乾可見部分。

注意: 機器只可以在萃取30杯咖啡或以上之後，才可以進入除磷模式。

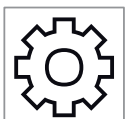
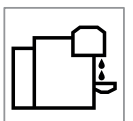
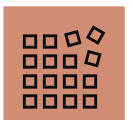
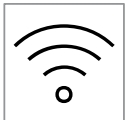

清空系統

清空系統以預備長期停用、作防霜保護或進行維修。

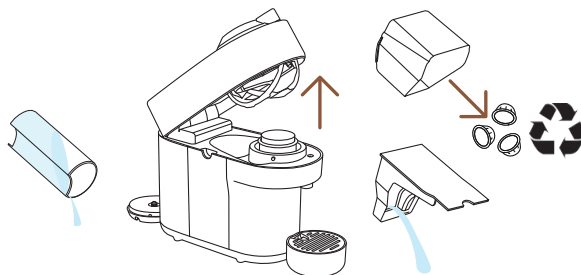

- 1** 清空水箱，打開機頭，讓已使用的粉囊退出。清空粉囊棄置格及滴水盤。請回收您的**Nespresso**粉囊*。

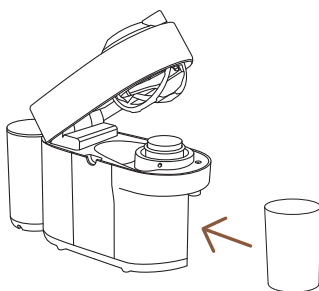

- 2** 將配件放回原位並移除杯架。在咖啡出口底下放置一個容量0.5公升的容器。

* 這是**Nespresso**。這是可回收的。更多有關回收**Nespresso**粉囊的信息，請瀏覽www.nespresso.com

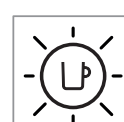
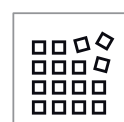
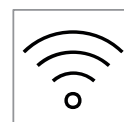

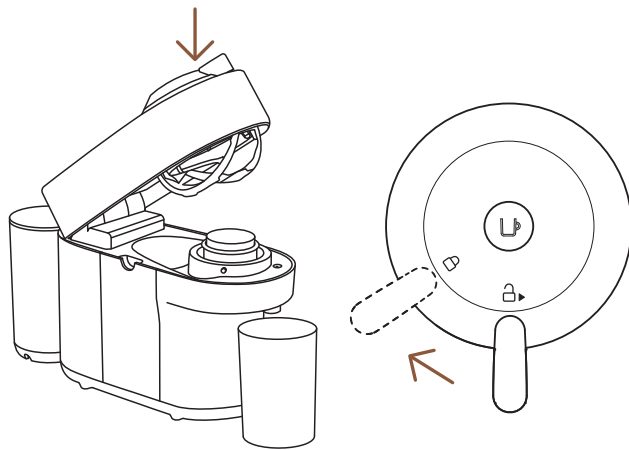

3 在連接電源及開機狀態下，將槓桿推至鎖定位置。

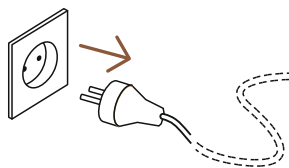

4 拔掉機器插頭。

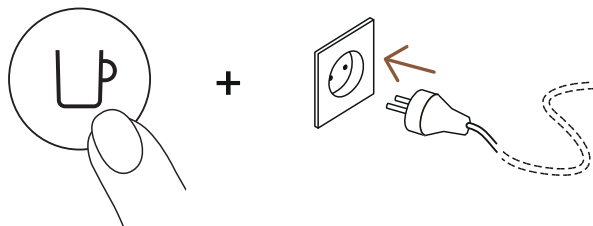

5 長按按鈕並插上電源。

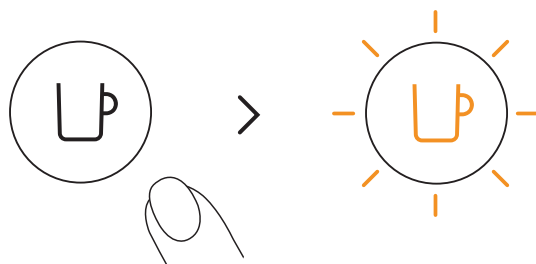

6 放開按鈕。橙色指示燈閃爍，代表清空程序開始。

i 完成清空程序需時大約30秒。當水已清空，咖啡機會自動關機。

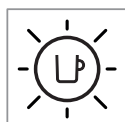
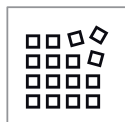
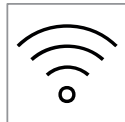

回復原廠設定

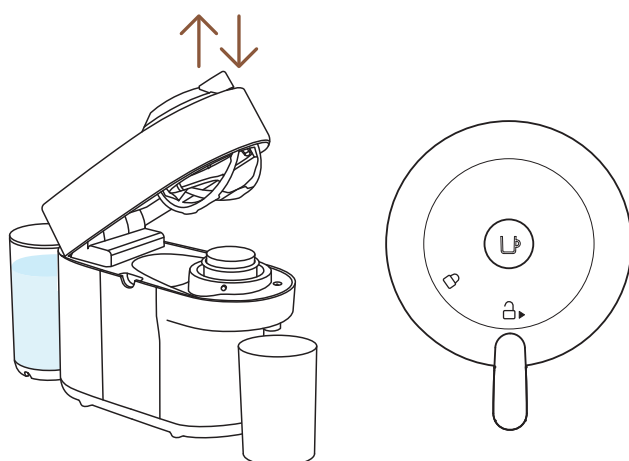

- 1** 連接電源的情況下，打開再合上機頭。然後將槓桿停留在解鎖位置。

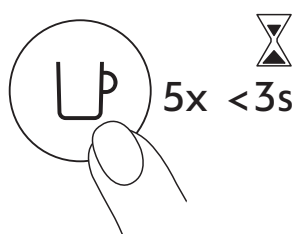

- 2** 3秒內按5次按鈕。咖啡機現在已回復原廠設定。

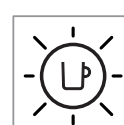
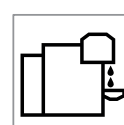
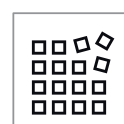
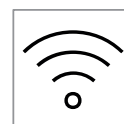

閃燈提示

想知道更多關於Vertuo Pop 的閃燈提示？
請觀看以下影片：



問題解答

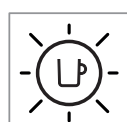
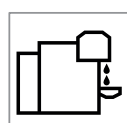
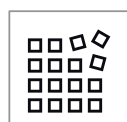
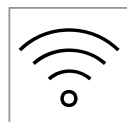

按鈕沒有亮起任何燈號

- 咖啡機自動關機；按下按鈕或解鎖咖啡機。
- 檢查總電源、電插座、電壓及保險絲。

沒有咖啡與水流出。

- 檢查水箱是否已加入食水。
- 檢查是否已正確放置新的粉囊，槓桿是否已鎖定並已按下開始按鈕。
- 如有需要，請為咖啡機除磷。
- 打開咖啡機頂部，退出粉囊，然後按照指引進行清洗。

咖啡不夠熱。

- 用加熱的食水預熱咖啡杯。
- 如有需要，請為咖啡機除磷。

漏水或咖啡流出速度異常。

- 檢查是否已正確放置水箱。
- 如有需要，請為咖啡機除磷。

咖啡機進入「關機模式」。

- 為了節省能源，咖啡機閒置2分鐘後會自動關機。
- 長按按鈕3秒，咖啡機即可手動關機（非使用中）。

杯中留有咖啡粉末。

- 進行2次清洗程序。
- 詳情請參閱「清洗」部分。

咖啡機未啟動，燈號已持續亮起。如燈號閃爍，請參閱以下數點。

- 檢查是否已正確鎖定槓桿。
- 如欲調製咖啡或 Espresso，請檢查是否已正確放置新的粉囊，槓桿是否已鎖定並已按下開始按鈕。
- 如您正在清洗、除磷或清空系統，請確認咖啡機內已沒有粉囊。然後關上頂部並鎖定咖啡機，再按下按鈕，開始進行有關程序。

咖啡機未啟動，燈號輪流閃爍；閃爍1次，再暫停1次。

- 為水箱加入食水，再按下按鈕開始。
- 檢查是否已正確鎖定槓桿。

咖啡機運作時燈號閃爍。

- 如咖啡正常流出，表示咖啡機運作正常。
- 如果只有水流，代表機器正執行用家指示（清洗、除磷或清空系統）。請參閱相關指引。
- 按下按鈕3秒關機。再按一次開機。稍等20秒，讓過度使用的咖啡機冷卻。

咖啡機未啟動，燈號持續閃爍。

- 咖啡將需要一段時間才流出，以讀取條碼及浸泡咖啡。
- 檢查是否已正確放置新的粉囊，槓桿是否已鎖定並已按下開始按鈕。
- 為水箱加入食水，再按下按鈕開始。
- 按下按鈕3秒關機。再按一次開機。稍等20秒，讓過度使用的咖啡機冷卻。

燈號持續輪流閃爍2次，再暫停 1次。咖啡機沒有運作。

- 調製咖啡 / Espresso 期間:
 - 1) 解鎖槓桿，打開咖啡機頂部，檢查是否已正確放置新而無損的粉囊。
 - 2) 檢查槓桿是否已調至「鎖定」位置。
 - 3) 檢查水箱是否已加入食水。
- 進行除磷、清空或清洗程序期間:
 - 1) 檢查粉囊是否已退出。
 - 2) 檢查槓桿是否已調至「鎖定」位置。
- 設定杯量大小期間:
 - 1) 檢查粉囊是否妥當放置。
 - 2) 請參閱相關指引。
- 如問題持續:
 - 1) 解鎖槓桿，打開咖啡機頂部。
 - 2) 重新放置粉囊 (如有需要)。
 - 3) 切斷電源，於10秒後再重新插上插頭。
 - 4) 關上咖啡機頂部，按下按鈕啟動咖啡機，再按一次開始調製。
 如果問題持續，請致電**Nespresso**。

燈號輪流閃爍3次，然後持續亮起。

- 需要除磷：出現此提示後，咖啡機仍可運作數次，隨後就需要進行除磷。

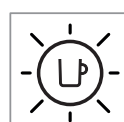
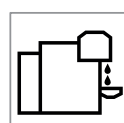
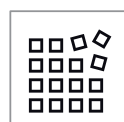
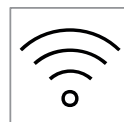

規格

功率	~220-240 V, 50-60 Hz, 1300-1500 W US, CA: 120 V, 60 Hz, 1500 W MX: 127 V~, 60 Hz, 1380 W
頻率	2.402-2.480 GHz
射頻輸出功率(EIRP)	藍牙 4dB 最大射頻輸出功率及無線熱點 <20 dMm 最大射頻輸出功率
待機	0.39 W/h
省電模式	自動關機: 2分鐘
預熱時間	30秒(機頭關閉及鎖上)
可移動杯架	可拆除單位
電線長度(由機身)	75 cm / 30 in
尺寸(濶 X 長 X 高)	13.6 x 42.6 x 25 cm / 5.3 x 16.7 x 9.8 in
重量	3.5 kg / 7.72 lbs
水箱容量	600 ml / 20 fl oz
粉囊棄置格容量	8 個 espresso 粉囊或 5 個 mug 粉囊

機器序號

Nespresso	Breville	Delonghi
GCV2, GDV2	BNV120, BNV150	ENV90
Krups	Magimix	
XN9201, XN9204, XN9205, XN9211	M800	



點擊並選擇您的語言

TW



安全須知



概述



連接功能



首次使用



調製咖啡



自訂咖啡杯量



清潔



除垢



清空系統



回復原廠設定



閃燈提示



故障排解



規格

安全須知

注意: 在操作咖啡機之前,請參閱安全指引手冊,以免造成傷害。

廢棄處理與環境保護

本產品符合歐盟指令2012/19/EU。包裝物料及咖啡機採用可回收或再利用的材質製成。您的咖啡機含有可恢復或循環再用的重要物料,將剩餘廢料分類,可有助回收此等可貴的物料。將咖啡機器至於收集點,建議您可向當地有關部門洽詢或索取棄置處理相關資料。

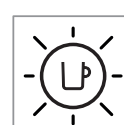
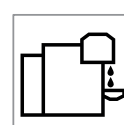
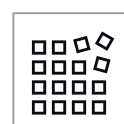
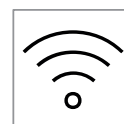

概述

機器概述

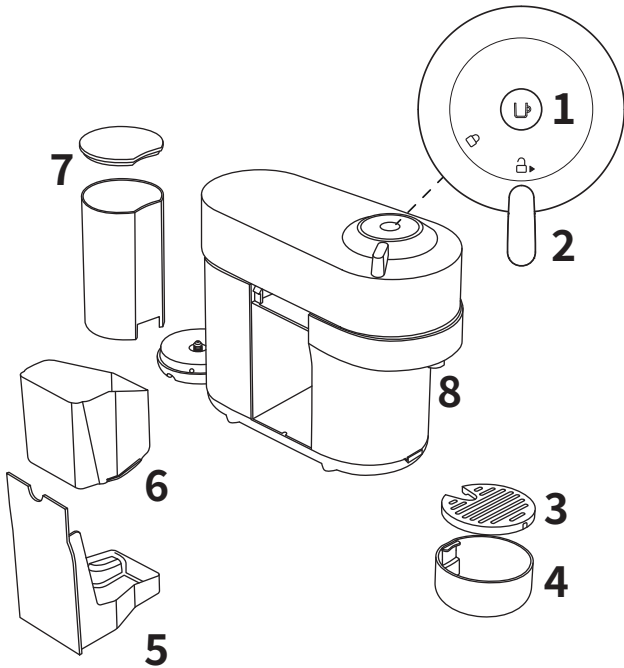

- 1 開／關及咖啡按鍵
- 2 鎖定／解鎖拉桿
- 3 滴水柵格
- 4 可調節式杯架
- 5 滴水盤
- 6 膠囊儲存盒
- 7 水箱和水箱蓋
- 8 咖啡出口

包裝內容



- 1 咖啡機
- 2 **Nespresso** 咖啡膠囊套裝
- 3 **Nespresso** 歡迎手冊
- 4 安全指引
- 5 快速入門指南
- 6 保固

i 開箱: 由於包裝中使用了回收材料, 機器表面可能會存在一些灰塵。這並不危險, 只需用軟紙巾清潔即可。

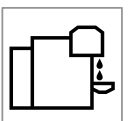
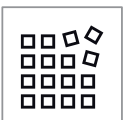
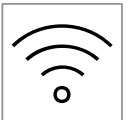

開 / 關

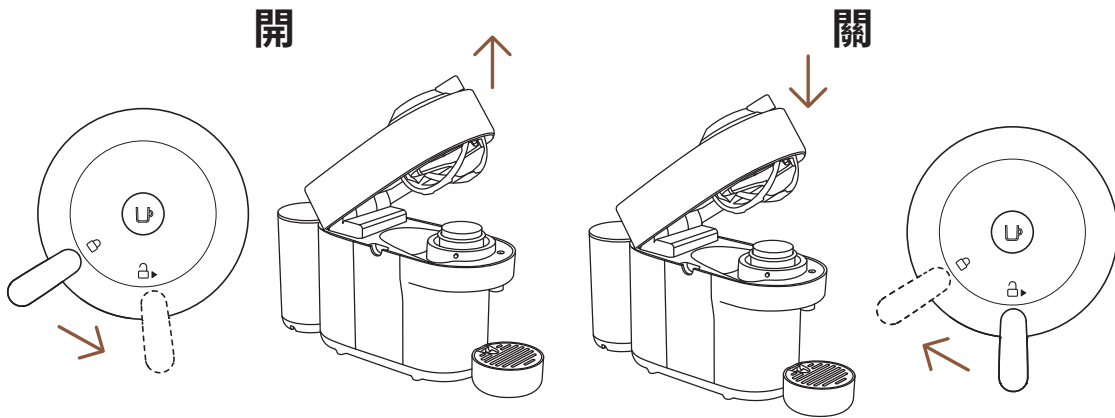

注意: 當咖啡機正在萃取咖啡時，在咖啡機完成萃取且白燈亮起前，請勿打開咖啡機上蓋。如果您想要提前停止萃取咖啡，可以隨時按咖啡按鍵，等待咖啡機停止運作，再打開上蓋。

VERTUO 系統

VERTUO系列膠囊



VERTUO系列配件

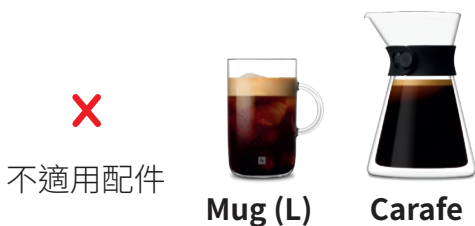

探索更多精美配件系列: www.nespresso.com

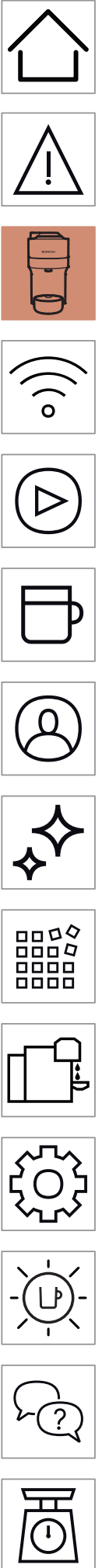

開／關

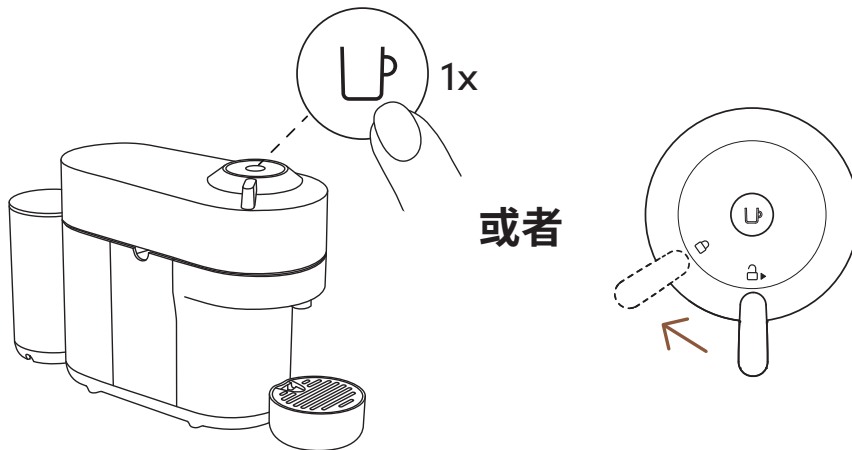

開

當咖啡機接上電源，請按咖啡按鍵或鎖定拉桿以啟動咖啡機。

- i** 當按鍵閃爍表示咖啡機正在暖機，過程約為30秒，直到白燈恆亮，代表咖啡機已準備就緒。

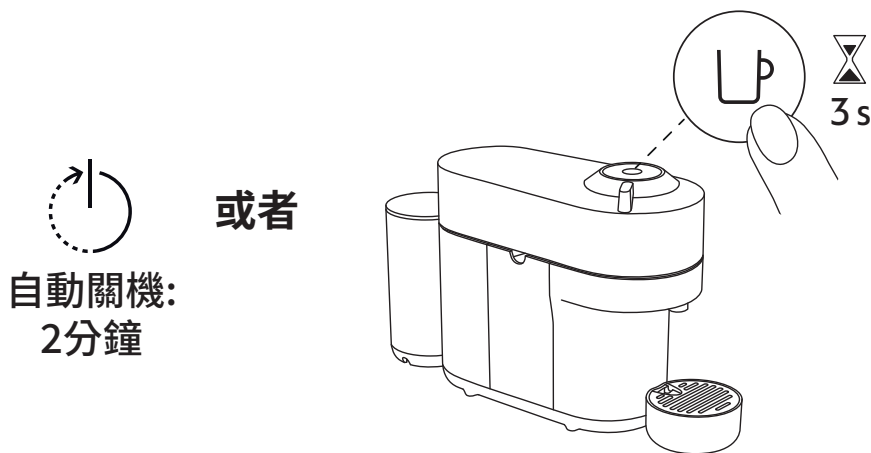

關

為了節省能源，咖啡機閒置2分鐘後會自動關機。

- i** 您可於咖啡機待機時，長按咖啡按鍵3秒以進行手動關機。

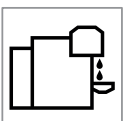
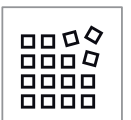

連接功能

為什麼要配對 VERTUO POP 機器



連接VERTUO POP 咖啡機的好處

- **智能咖啡:** 取得最新的咖啡機資訊讓機器始終保持更新。
- **專業建議:** 透過手機取得咖啡機使用教學影片，輕鬆上手。
- **咖啡機保養:** 提供疑難排解資訊，以及機器除垢、沖洗和清潔指引。

如何連接您的VERTUO POP 咖啡機？

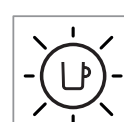
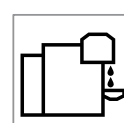
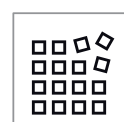

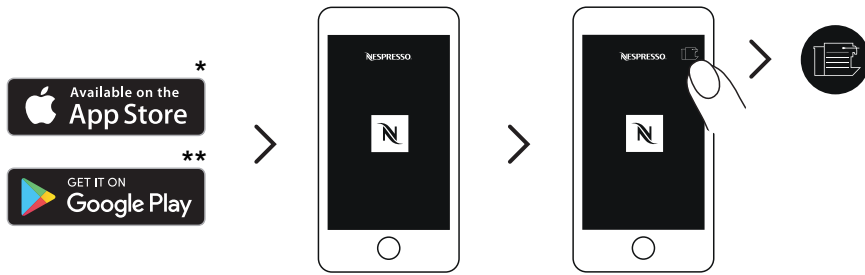

1 使用手機下載並開啟**Nespresso**應用程式，輕觸螢幕右上方的咖啡機圖示。

注意: 我們建議您使用Wi-Fi路由器進行連接配對，而不要使用手機熱點，以確保連接穩定。

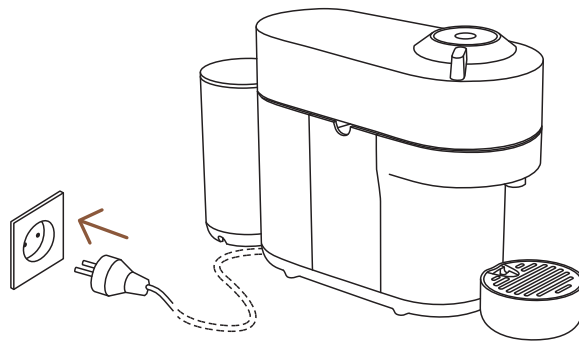

2 將插頭接上電源。



3 依照**Nespresso**應用程式指示進行操作。

注意: 請先參閱安全指引手冊並確保咖啡機插頭穩固地插上電源並確保接地線連接，以避免觸電危險或造成火災。

* App Store®是Apple Inc.在美國及其他國家和地區註冊的商標。
 ** Google Play 和 Google Play 標誌是 Google LLC. 的商標。

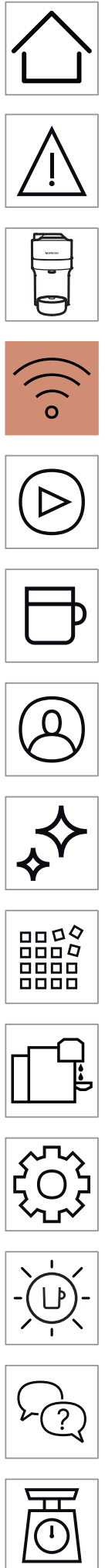

關閉咖啡機藍芽和WI-FI連接功能

咖啡機在原廠設定下，連接功能為開啟狀態，以提升咖啡體驗。如果您想要關閉連接功能，請依照以下指示：

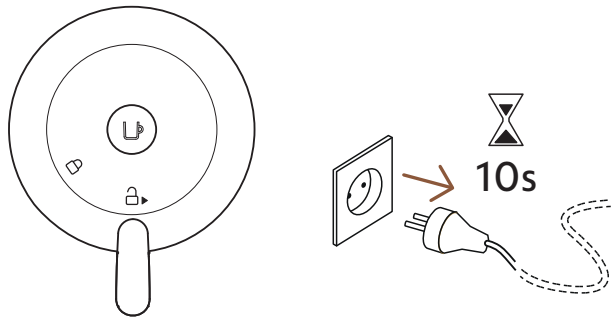

- 1** 關閉咖啡機上蓋並解鎖拉桿，拔掉插頭至少10秒鐘。

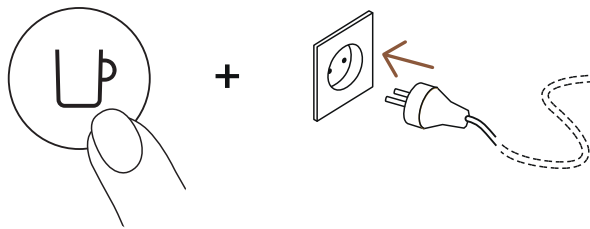

- 2** 長按按鍵並插上電源。咖啡按鍵閃爍橘燈表示連接功能已關閉。
- i** 您可依照以上相同的步驟重新開啟連接功能，咖啡按鍵亮起白燈即表示重啟成功。

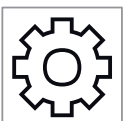
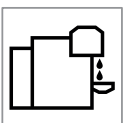
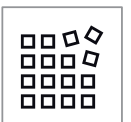

首次使用

首次清洗

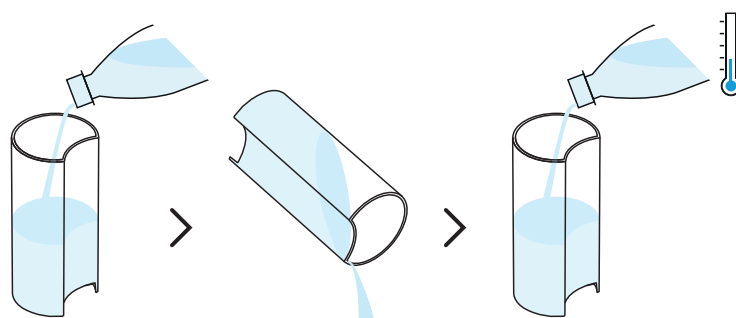

- 1** 請沖洗水箱及水箱蓋，並加入飲用水至水箱。

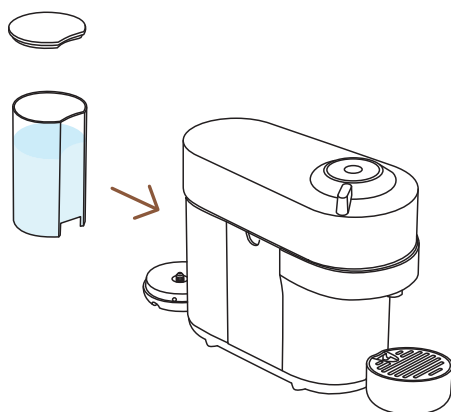

- 2** 蓋上水箱蓋並將水箱放回原位。

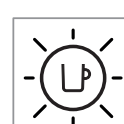
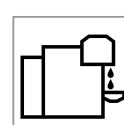
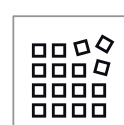
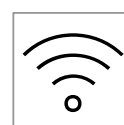

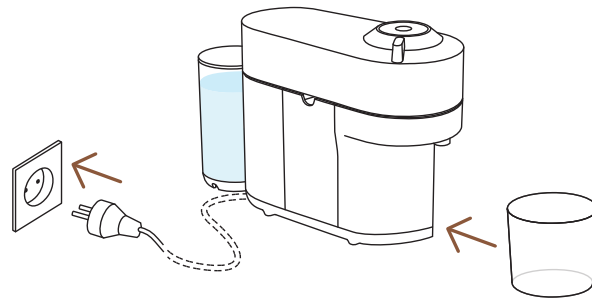

- 3** 接上咖啡機電源並移除杯架，放置一容器(至少1公升容量)於咖啡出口處。

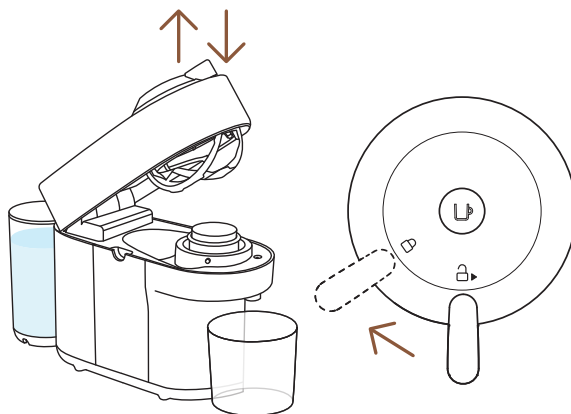

- 4** 打開並關閉咖啡機上蓋後，請將咖啡機拉桿鎖定。

- i** 當按鍵閃爍表示咖啡機正在暖機，過程約為30秒，直到白燈恆亮，代表咖啡機已準備就緒。請確保不要放置任何咖啡膠囊。

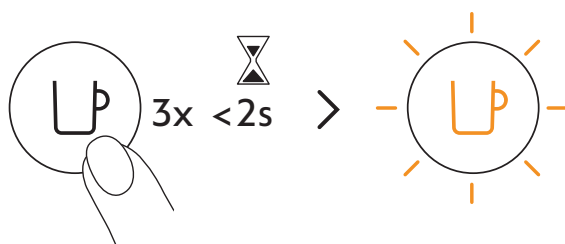

- 5** 請於2秒內連續按咖啡按鍵3次，機器將開始自動沖洗，此過程最多可能需要7分鐘。當白燈亮起，表示已完成清洗。

- i** 咖啡機將在2分鐘內開始進行清洗流程，此過程最多可能需要7分鐘。



調製咖啡

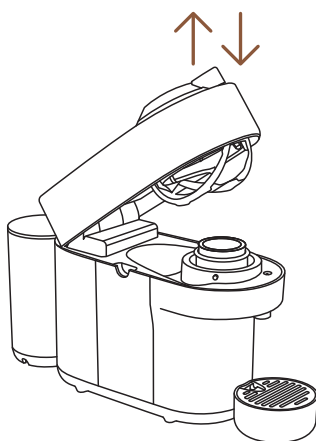

1 開啟並關閉咖啡機上蓋。

i 當按鍵閃爍表示咖啡機正在暖機，直到白燈恆亮，代表咖啡機已準備就緒。

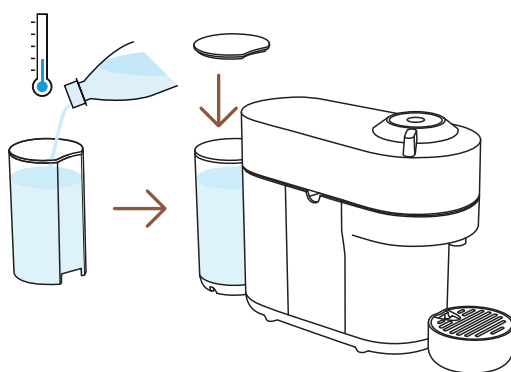

2 將飲用水倒入水箱並將水箱放回原位。

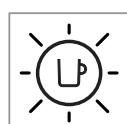
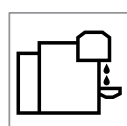
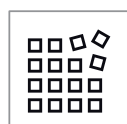
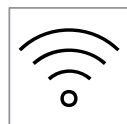

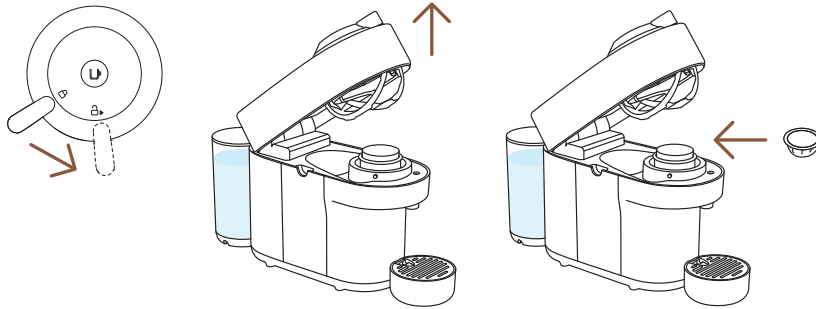

- 3** 解鎖拉桿並完全打開咖啡機上蓋，放入一顆Vertuo咖啡膠囊，膠囊圓弧球面朝下。

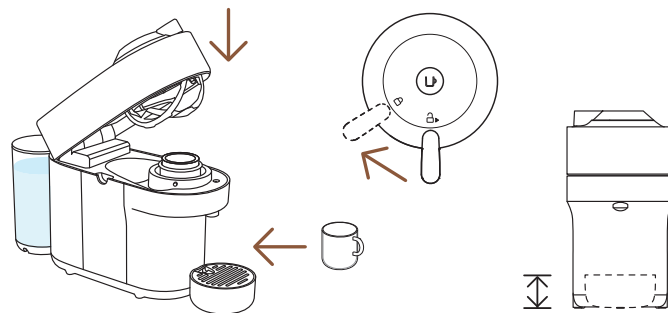

- 4** 關閉咖啡機上蓋並鎖定拉桿，放置一個咖啡杯於咖啡出口處，杯架位置可依據您杯子的大小做調整。

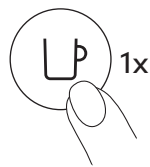

- 5** 按壓咖啡按鍵開始萃取。

注意：當咖啡機正在萃取咖啡時，在咖啡機完成萃取且白燈亮起前，請勿打開咖啡機上蓋。如果您想要提前停止萃取咖啡，可以隨時按咖啡按鍵，等到咖啡機停止運作，再打開上蓋。

- i** 我們的獨家條碼辨識技術，將完美萃取參數編碼至每顆膠囊中，咖啡開始萃取前需要一些預浸時間，搭配一鍵萃取系統，即可享受完美咖啡！

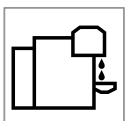

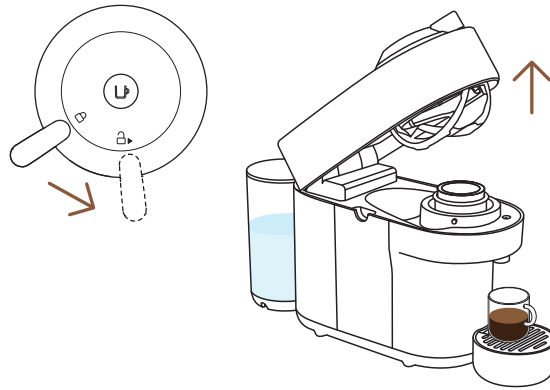

- 6** 咖啡機停止萃取時，解鎖拉桿並打開咖啡機上蓋，咖啡膠囊將自動退出至膠囊儲存盒，方可享用您的咖啡。



- 7** 別忘了回收您的**Nespresso**咖啡膠囊。*

* 這是**Nespresso**。這是可回收的。更多有關回收**Nespresso**咖啡膠囊的資訊，請瀏覽www.nespresso.com

探索「濃縮杯量模式」



搭配此款咖啡機，**Nespresso**提供您「濃縮杯量模式」萃取您最愛的咖啡食譜。

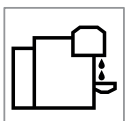
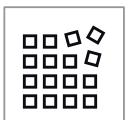
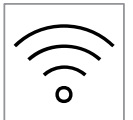

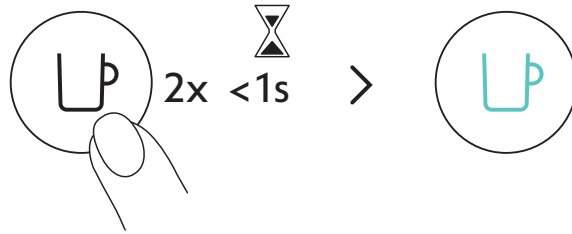

咖啡機於待機模式下，按兩下萃取鍵(閃藍燈)，可獲得更濃縮的杯量，為您的冰咖啡或牛奶咖啡食譜增添濃郁口感，享受無以倫比的咖啡體驗。

40 毫升	80 毫升	150 毫升	230 毫升	355 毫升	535 毫升
✓	✓	✓	✓	✗	✗
25 毫升	40 毫升	40 毫升	80 毫升		

我們建議機能性咖啡(Coffee+)、特大杯臻選咖啡(XL)、冷萃感咖啡(Cold Brew)和工藝精萃咖啡(Craft Brew)建議使用原廠最佳萃取杯量設定飲用，不適用此濃縮杯量模式，以達最佳口感。

注意: 必須於 **Nespresso** 應用程式更新系統版本，方能使用「濃縮杯量模式」。

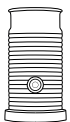

探索更多Aeroccino奶泡機系列以升級您的咖啡體驗：
www.nespresso.com

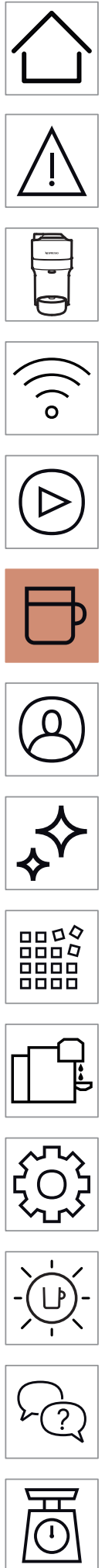

自訂咖啡杯量

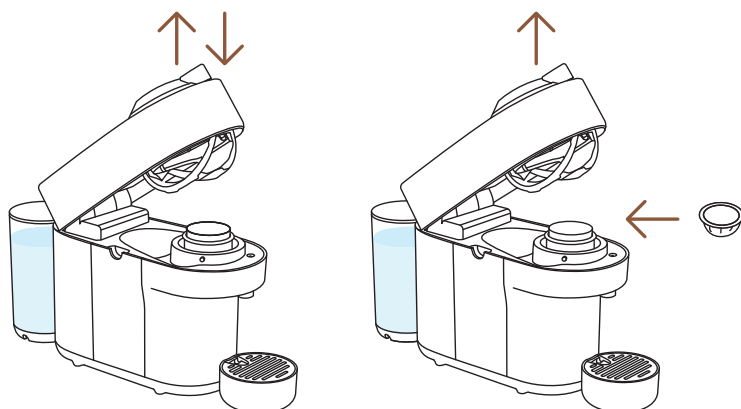

- 1** 打開機器上蓋並放入您想要設定杯量的咖啡膠囊。

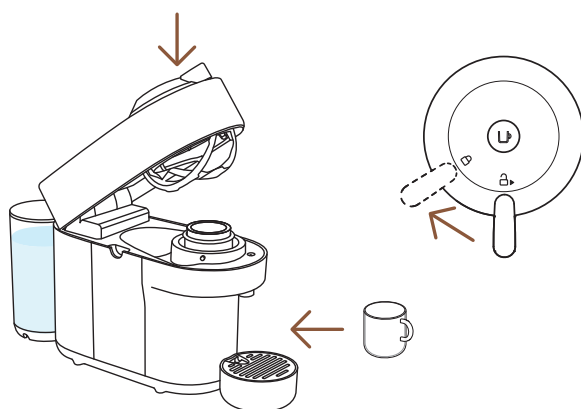

- 2** 關上機器上蓋，將拉桿向左轉至上鎖位置，並放上一個杯子。

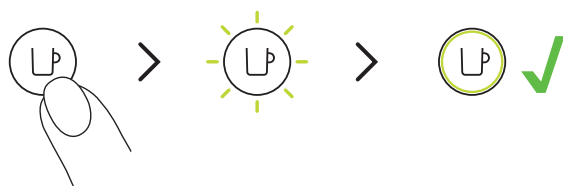

- 3** 長按咖啡按鍵萃取咖啡，達到理想杯量前幾秒，放開按鍵。此款咖啡膠囊的新杯量已完成設定。

- i** 此功能是根据放入的膠囊口味所設定。杯量自訂範圍為20毫升至535毫升。

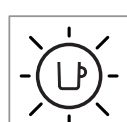
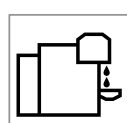
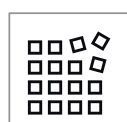
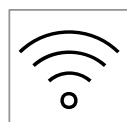

注意: 為正確使用咖啡機，請勿於咖啡萃取時，打開咖啡機上蓋。請待咖啡按鍵顯示白燈，再開啟咖啡機上蓋。如欲提早停止萃取，請於萃取過程中，按咖啡按鍵一次，等待咖啡機停止運作後，再打開咖啡機上蓋。

注意: 當您設定好杯量後，每當放入該膠囊口味，萃取杯量將根據設定的杯量而定。如想回復預設杯量，請參閱“[回復原廠設定](#)”。

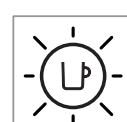
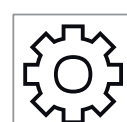
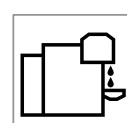
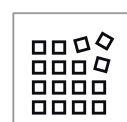
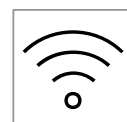

清潔

當您的咖啡機上蓋內部出現咖啡渣，或經長期停用之後，請每月清洗您的咖啡機。

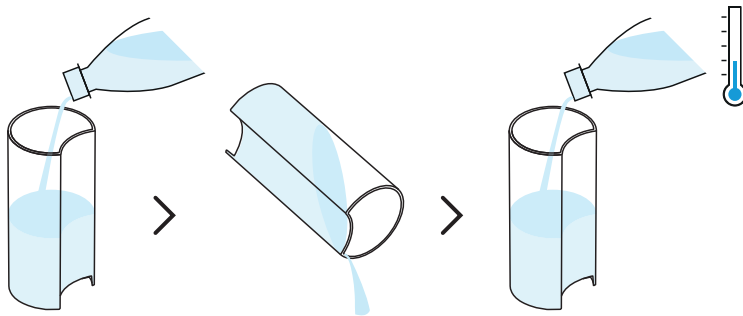

1 清洗水箱及水箱上蓋後，注入新鮮飲用水。

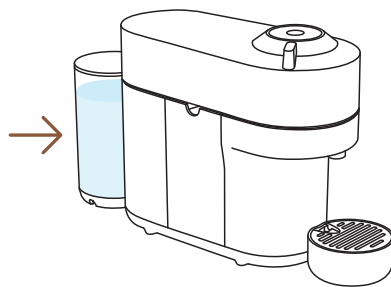

2 將水箱放回原位。

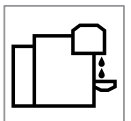
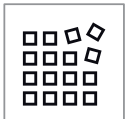

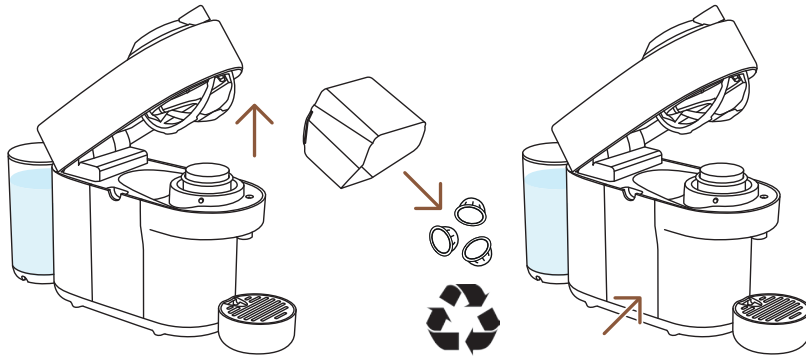

- 3** 解鎖並打開咖啡機上蓋，退出已使用的膠囊。清空並沖洗膠囊儲存盒和滴水盤，然後放回原位。別忘了回收您的 **Nespresso** 膠囊。*

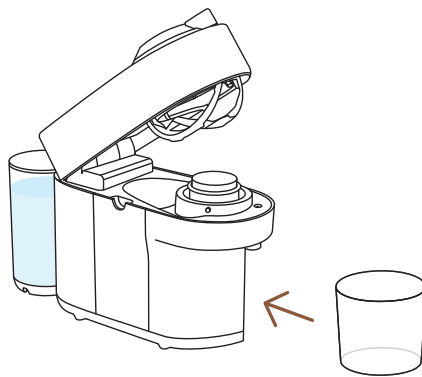

- 4** 移開杯架並在咖啡出水口處放置一個容量至少1公升的容器。

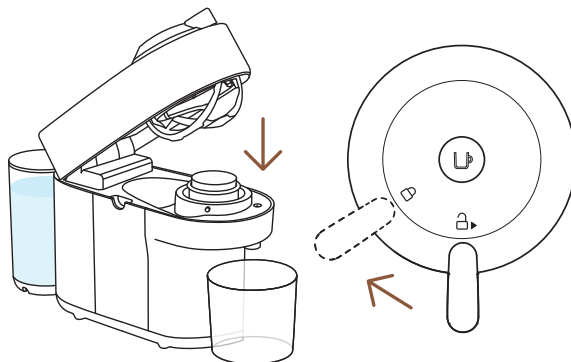

- 5** 關閉咖啡機上蓋並將拉桿向左轉至鎖定位置。清洗程序開始前，請確保沒有放置任何咖啡膠囊。

* 這是 **Nespresso**。這是可回收的。更多有關回收 **Nespresso** 咖啡膠囊的資訊，請瀏覽 www.nespresso.com

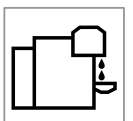
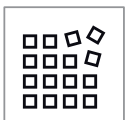

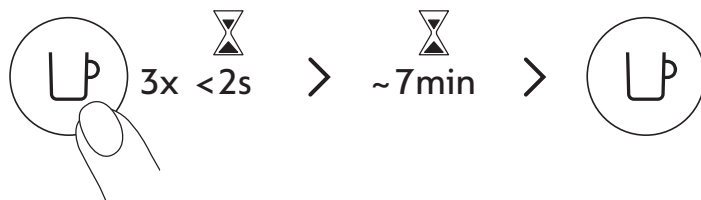

- 6** 於2秒內按咖啡按鍵3次以啟動沖洗程序，咖啡按鍵閃爍橘燈下，請讓沖洗程序自動完成。
- i** 在2分鐘內，咖啡機會開始進行清洗並有水流。清洗過程需時7分鐘，並會在完成之後自動停止。過程中也可以隨時按下咖啡按鍵停止。

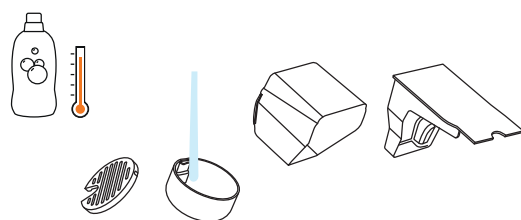

- 7** 用溫熱水及溫和無味的清潔劑沖洗膠囊儲存盒、杯架及滴水盤。

注意: 請勿使用強力清潔劑、強力磨砂及溶劑清潔劑。請勿將咖啡機放入洗碗機。請勿將咖啡機及其部分浸入水中。

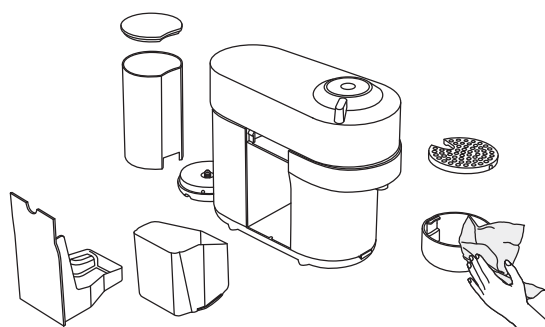

- 8** 用乾淨的毛巾擦乾

注意: 請定期使用乾淨的濕布清潔咖啡出水口。請務必使用柔軟的抹布清潔咖啡機。

注意: 水可能會殘留在咖啡機上蓋，請使用乾淨的乾布擦拭可見的部分。

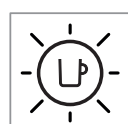
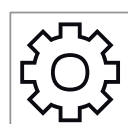
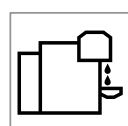
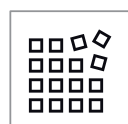
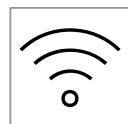

除垢

為您的咖啡機除垢以確保在使用壽命內正常運作，帶給您無與倫比的咖啡體驗。當咖啡機需要除垢時，在白色指示燈亮起前，會先閃爍橙色指示燈3次。



i 除垢程序需要大約20分鐘，且不能中斷。

注意：開始前，請仔細閱讀除垢指引。

您將需要：

- **Nespresso** 除垢劑，可於 www.nespresso.com 選購。
- 空容器 (1公升)

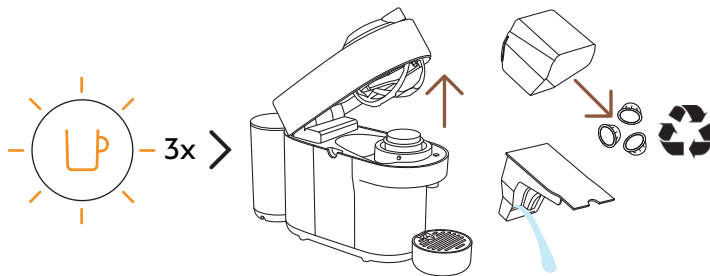

1 橙色指示燈閃爍3次：解鎖並打開咖啡機上蓋，退出已使用的膠囊。清空膠囊儲存盒及滴水盤，然後放回原位。別忘了回收您的 **Nespresso** 膠囊。*

* 這是 **Nespresso**。這是可回收的。更多有關回收 **Nespresso** 咖啡膠囊的資訊，請瀏覽 www.nespresso.com



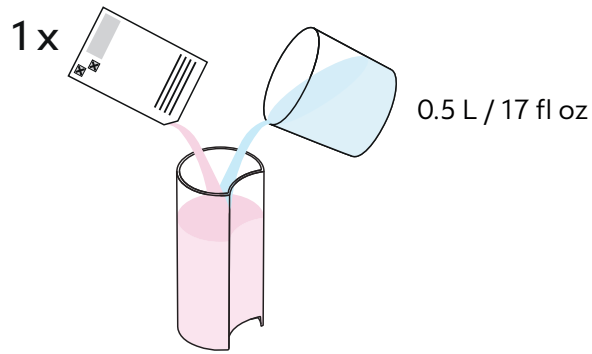

2 在水箱注入0.5公升飲用水，再加入一份除垢液。

注意：除垢液有危害風險。避免觸及眼睛、皮膚和其他表面。

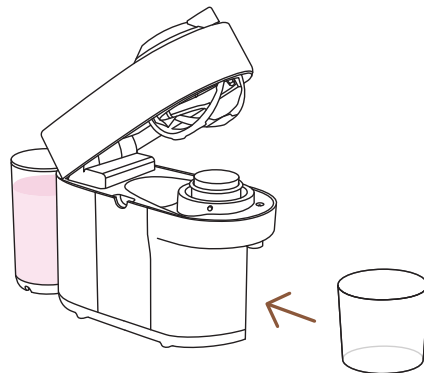

3 移除杯架並在咖啡出水口放置一個容量至少1公升的空容器。

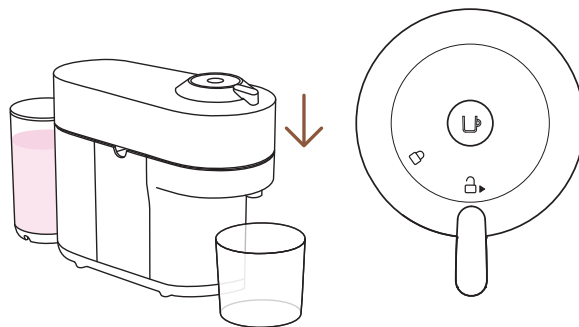

4 在開機狀態下，關閉咖啡機上蓋，並將拉桿停留在解鎖位置。

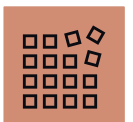

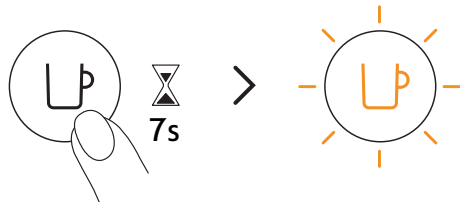

- 5** 長按咖啡按鍵至少7秒鐘，或直到指示燈熄滅。接著橙色指示燈會開始快速閃爍。

注意： 您有45秒的時間進入除磷模式，否則機器將回到待機模式。

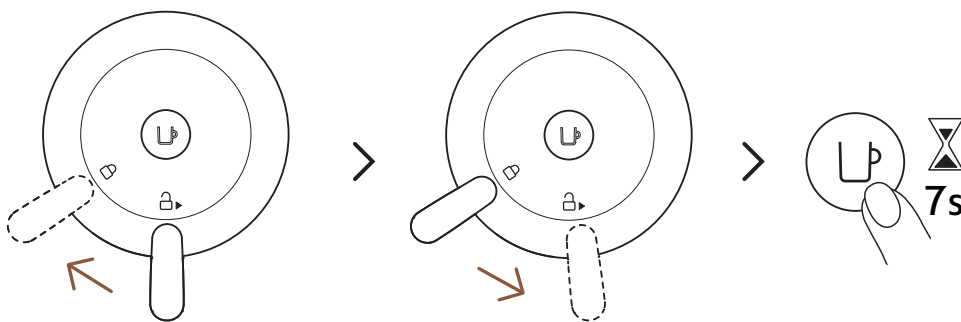

- 6** 將拉桿向左轉至鎖定位置，再將拉桿向右轉至解鎖位置。再次長按咖啡按鍵最少7秒或直到指示燈熄滅。接著橙色指示燈會再次快速閃爍。

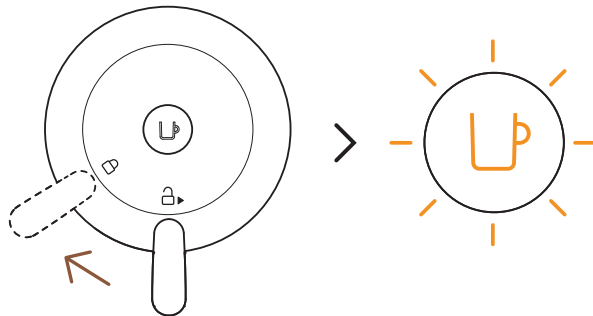

- 7** 如要進入除垢模式，請將拉桿向左轉至鎖定位置。橙色指示燈仍然會持續閃爍。此時咖啡機已進入除垢模式。

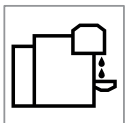
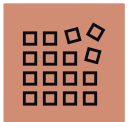

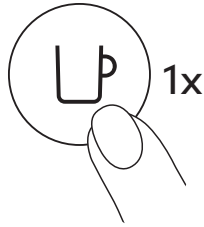

- 8** 按下咖啡按鍵一次，開始除垢程序。過程中，橙色指示燈會持續閃爍。

i 第一階段除垢程序完成後，咖啡機會自動停止運作。

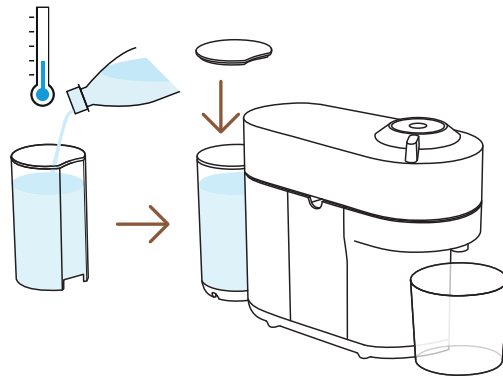

- 9** 除垢程序結束後，咖啡機要進行沖洗程序。請徹底清洗水箱及滴水盤。接著在水箱注滿新鮮飲用水，並放回原位。同時也必須清空容器，然後放回咖啡出水口下方。

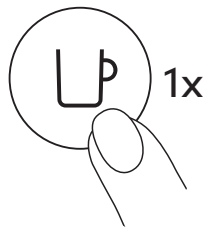

- 10** 按下咖啡按鍵開始沖洗咖啡機。當指示燈穩定並停止閃爍，代表除垢程序已經完成。

i 沖洗程序完成後，機器會自動停止。

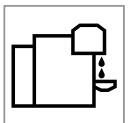

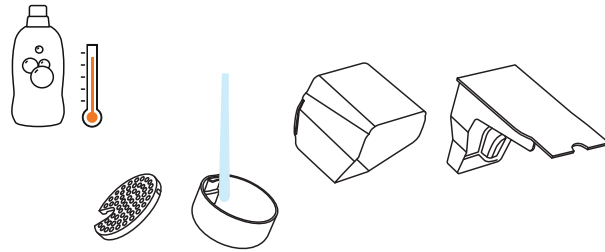

11 使用溫熱水及溫和無味清潔劑清洗膠囊儲存盒、杯架及滴水盤。

注意: 請勿使用強力清潔劑、強力磨砂及溶劑清潔劑。請勿將咖啡機放入洗碗機。請勿將咖啡機及其部分浸入水中。

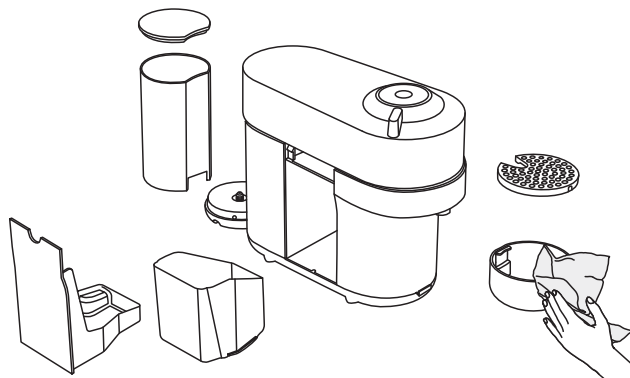

12 用乾淨的毛巾擦乾咖啡機。開始使用咖啡機前，請讓咖啡機風乾10分鐘。

注意: 水可能會殘留在咖啡機上蓋，請使用乾淨的乾布擦拭可見的部分。

注意: 咖啡機只能在萃取30份以上的咖啡後，才可以進入除垢模式。

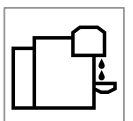
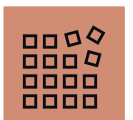
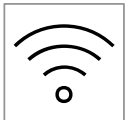

清空系統

欲長期停用、維修前或除霜保護需進行清空系統。

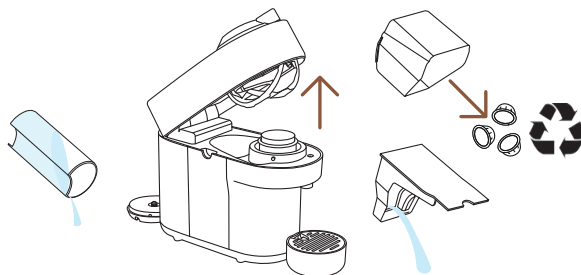

- 1** 清空水箱，並打開咖啡機上蓋，退出已使用的膠囊。清空膠囊儲存盒及滴水盤。別忘了回收您的 **Nespresso** 膠囊。*

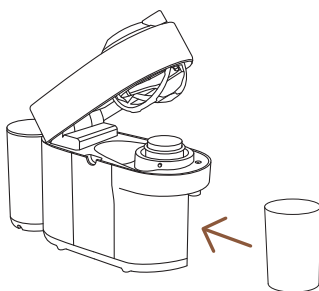

- 2** 將配件放回原位並移除杯架。在咖啡出水口下放置一個容量0.5公升的空容器。

* 這是 **Nespresso**。這是可回收的。更多有關回收 NESPRESSO 咖啡膠囊的資訊，請瀏覽 www.nespresso.com

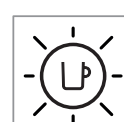
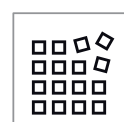
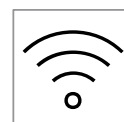

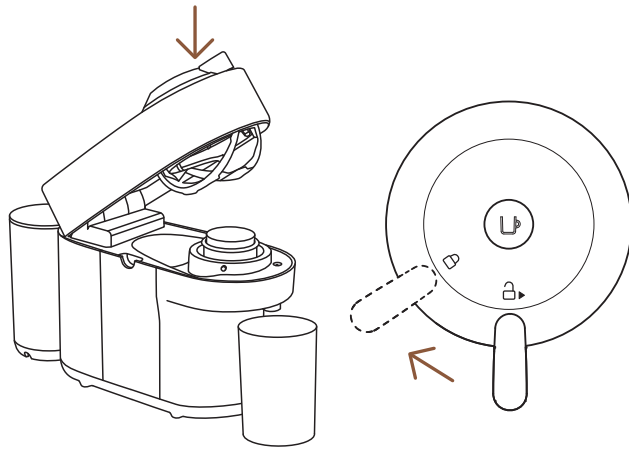

3 連接好電源並開機，闔上咖啡機上蓋，將拉桿轉至鎖定位
置。

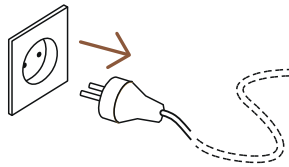

4 拔掉機器插頭

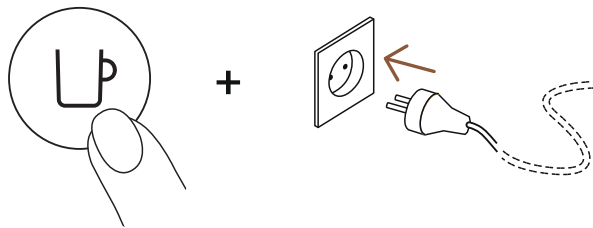

5 長按咖啡按鍵並插上電源

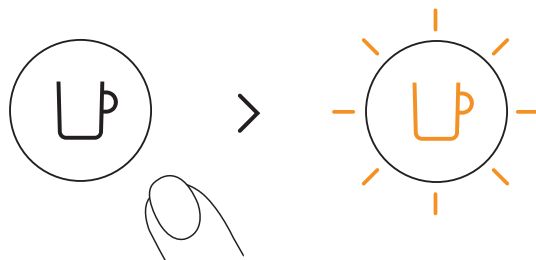

6 放開按鍵。橙色指示燈開始閃爍，代表進入清空程序。

i 清空程序需時大約30秒。完成時，咖啡機會自動關機。

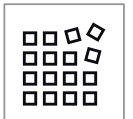
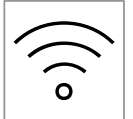

回復原廠設定

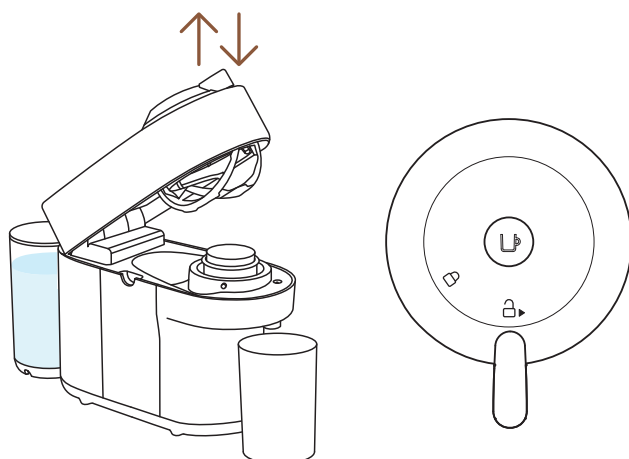

- 1** 連接好電源，打開再閉咖啡機上蓋。將拉桿停留在解鎖位置。

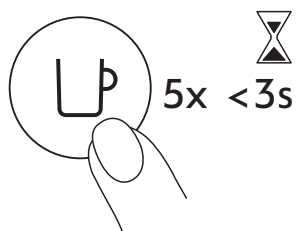

- 2** 於3秒內按下咖啡按鍵5次。咖啡機現在已回復原廠設定。

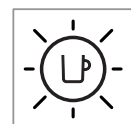
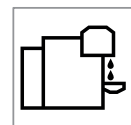
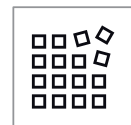
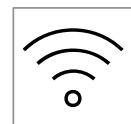

閃燈提示

想了解更多關於 Vertuo Pop 的閃燈提示？請觀看以下影片：



故障排解

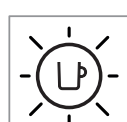
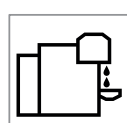
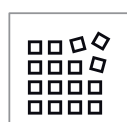
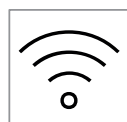

按鍵沒有亮起任何燈號

- 咖啡機已自動關機；按下按鍵或解鎖咖啡機。
- 檢查總電源、電插座、電壓及保險絲。

沒有咖啡，沒有水

- 檢查水箱是否已加入飲用水。
- 檢查是否已正確放入新的膠囊，拉桿是否已鎖定並已按下咖啡按鍵。
- 必要時，請進行除垢。
- 打開咖啡機上蓋，退出膠囊，然後依照指引進行清洗。

咖啡溫度不足

- 使用熱飲用水預熱咖啡杯。
- 必要時，請進行除垢。

漏水或咖啡流出速度異常。

- 檢查是否已正確放置水箱。
- 必要時，請進行除垢。

咖啡機進入「關機模式」。

- 為了節省能源，咖啡機閒置2分鐘後會自動關機。
- 咖啡機處於待機狀態下，長按咖啡按鍵3秒，可以將咖啡機關機。

杯中留有咖啡粉末。

- 進行2次清洗程序。
- 請參閱「清洗」部分。

咖啡機沒有啟動，燈號已持續亮起。如燈號閃爍，請參閱下一項疑難排解。

- 檢查是否已正確鎖定拉桿。
- 如欲萃取咖啡，請檢查是否已正確放置新的膠囊，拉桿是否已鎖定並已按下開始按鍵。
- 如您正在清洗、除垢或清空系統，請確認咖啡機內已沒有膠囊，然後關上咖啡機上蓋並鎖定咖啡機，再按下按鍵，開始進行相關程序。

咖啡機沒有啟動，燈號交替閃爍；閃爍1次，並暫停1次。

- 為水箱注入飲用水，再按下按鍵啟動咖啡機。
- 檢查是否已正確鎖定拉桿。



咖啡機運作時，燈號閃爍。

- 如咖啡正常流出，表示咖啡機運作正常。
- 若只有水流出，咖啡機可能正在進行清洗、除垢或清空系統。請參閱相關指引。
- 按下咖啡按鍵3秒使咖啡機進入「關機模式」，接著再按下按鍵啟動咖啡機。等待約20分鐘，使咖啡機得以在長時間過度運作冷卻。

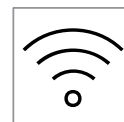

咖啡機沒有運作，燈號閃爍。

- 咖啡將需要一段時間才會流出，以讀取條碼及預浸泡咖啡。
- 檢查是否已正確放入新的膠囊，拉桿是否已鎖定並已按下開始按鍵。
- 為水箱注入飲用水，再按下按鍵開始。
- 按下咖啡按鍵3秒使咖啡機進入「關機模式」，接著再按下按鍵啟動咖啡機。等待約20分鐘，使咖啡機得以在長時間過度運作後冷卻。



燈號持續交替閃爍2次，並暫停1次。咖啡機沒有運作。

- 調製咖啡期間：
 - 1) 解鎖拉桿，打開咖啡機上蓋，檢查是否已正確放置新的且無損的膠囊。
 - 2) 檢查拉桿是否已調至「鎖定」位置。
 - 3) 檢查水箱是否已加入飲用水。
- 進行除垢、清空或清洗程序期間
 - 1) 檢查膠囊是否已退出。
 - 2) 檢查拉桿是否已調至「鎖定」位置。
- 設定杯量大小期間
 - 1) 檢查是否已正確放置膠囊。
 - 2) 請參閱相關指引。

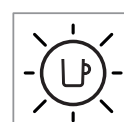
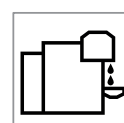
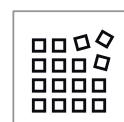

燈號閃爍3次,然後恆亮。

- 如問題持續:
 - 1) 解鎖拉桿,打開咖啡機上蓋。
 - 2) 重新放置膠囊(如有需要)。
 - 3) 切斷電源,於10秒後再重新插上插頭。
 - 4) 關閉咖啡機上蓋,按下按鍵啟動咖啡機,並再次按下按鍵開始調製咖啡。如問題持續,請聯絡 **Nespresso**。

- 需要除垢:出現此提示後,咖啡機仍可運作數次,隨後就需要進行除垢。

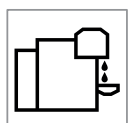

規格

電源	~220-240 V, 50-60 Hz, 1300-1500 W US, CA: 120 V, 60 Hz, 1500 W MX: 127 V~, 60 Hz, 1380 W TW: 110 V, 60 Hz, 1300 W
頻率	2.402-2.480 GHz
射頻輸出功率(EIRP)	藍芽 4 dBm 最大射頻輸出功率及無線網路 <20 dMm 最大射頻輸出功率
待機	0.39 W/h
省電模式	自動關機: 2分鐘
預熱時間	30秒 (咖啡機上蓋關閉並上鎖)
杯架	可移動式
電線長度 (由機身起)	75 公分
尺寸 (寬 X 長 X 高)	13.6 x 42.6 x 25 公分
重量	3.5 公斤
水箱容量	0.6 公升
膠囊儲存盒容量	8 顆濃縮咖啡或5顆大杯咖啡膠囊

機器代碼

Nespresso	Breville	Delonghi
GCV2, GDV2	BNV120, BNV150	ENV90
Krups	Magimix	
XN9201, XN9204, XN9205, XN9211	M800	

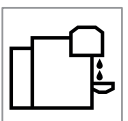

คลิกและเลือกภาษาของคุณ

TH



ความปลอดภัย



ภาพรวม



การเชื่อมต่อ



ขั้นตอนแรก



การเตรียมเครื่องดื่ม (กาแฟ)



ปรับระดับปริมาณกาแฟของคุณ



การทำความสะอาด



การขจัดคราบตะกรัน



การล้างระบบ (การถ่ายน้ำออกจากระบบ)



คืนค่าสู่การตั้งค่าจากโรงงาน



สถานะไฟกระพริบ



การแก้ไขปัญหาเบื้องต้น



ข้อมูลจำเพาะทางเทคนิค

ความปลอดภัย

ข้อควรระวัง: ก่อนใช้งานเครื่องชงกาแฟของคุณ โปรดดูเอกสารคำแนะนำด้านความปลอดภัยเพื่อหลีกเลี่ยงอันตรายและความเสียหายที่อาจเกิดขึ้น

การกำจัดและการรักษาสິงแวดล้อม

เครื่องใช้ไฟฟ้านี้เป็นไปตามระเบียบ EU Directive 2012/19/EC. บรรจุกัณฑ์และเครื่องใช้ไฟฟ้าของคุณประกอบด้วยวัสดุที่สามารถนำมาฟื้นฟูสภาพหรือนำกลับมาใช้ใหม่ได้โดยควรต้องได้รับการคัดแยกวัสดุอย่างถูกต้องเหมาะสมเสียก่อน กรุณาทิ้งเครื่องไว้กับจุดรับคืนซากเครื่องหรือจุดรับรีไซเคิลที่มีการประกาศไว้จากทางการของท้องถิ่นของท่าน

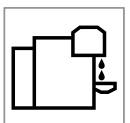

ภาพรวม

ภาพรวมของเครื่อง

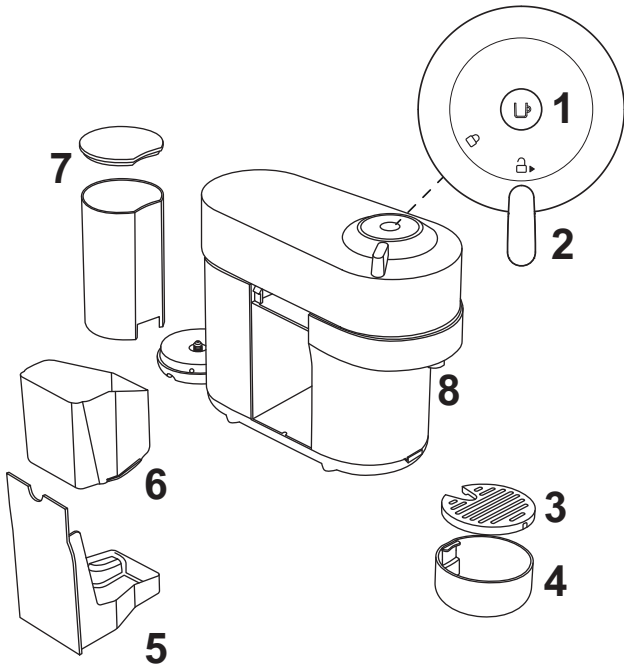

- 1 ปุ่มเปิด/ปิด และปุ่มทำกาแฟ
- 2 ก้านล็อกและปลดล็อก
- 3 ตะแกรงน้ำหยด
- 4 ฐานรองแก้วแบบปรับระดับได้
- 5 ถาดรองน้ำ
- 6 กล่องบรรจุแคปซูลที่ใช้แล้ว
- 7 ถังน้ำพร้อมฝาปิด
- 8 ช่องปล่อยกาแฟ

ส่วนประกอบของบรรจุภัณฑ์



- 1 เครื่องชงกาแฟ
- 2 ชุดแคปซูลกาแฟ Nespresso
- 3 หนังสือต้อนรับเข้าสู่ Nespresso
- 4 คำแนะนำด้านความปลอดภัย
- 5 คู่มือเริ่มต้นใช้งานฉบับย่อ
- 6 การรับประกัน

i การแกะกล่อง: เมื่อนำเครื่องชงกาแฟออกจากกล่องและนำพลาสติกที่ห่อหุ้มเครื่องออก อาจพบฝุ่นบนพื้นผิวของเครื่องซึ่งไม่เป็นอันตรายต่อผู้ใช้งาน เนื่องจากบรรจุภัณฑ์ทำจากวัสดุรีไซเคิล สามารถทำความสะอาดด้วยการใช้ผ้าสะอาดเช็ดทำความสะอาด

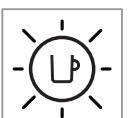
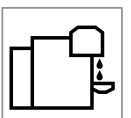
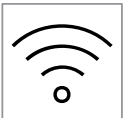

เปิด/ปิด

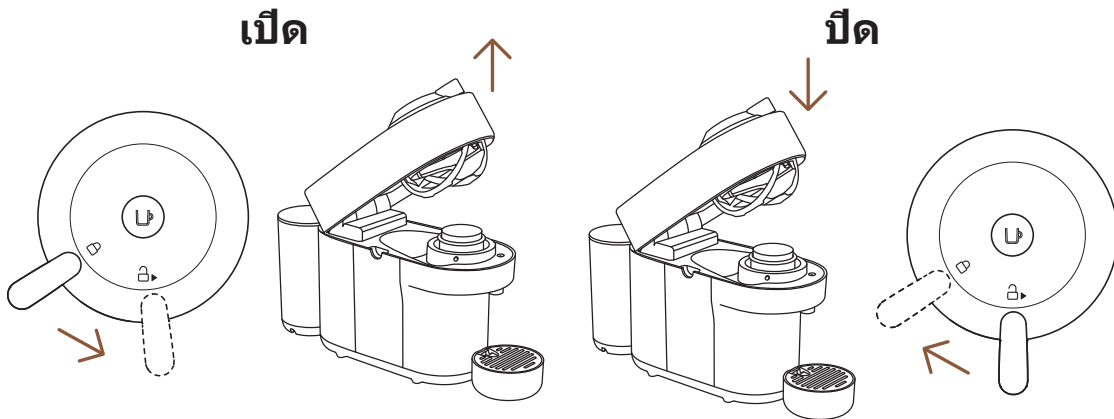

ข้อควรระวัง: เพื่อการใช้งานเครื่องที่เหมาะสม ห้ามเปิดหรือยกส่วนหัวของเครื่องชงกาแฟในขณะที่เครื่องกำลังทำกาแฟ ให้รอจนกว่าสถานะไฟที่ปุ่มทำกาแฟกลับไปเป็นสีขาวสว่างคงที่ หากคุณต้องการหยุดการทำกาแฟ ให้กดปุ่มทำกาแฟหนึ่งครั้งและรอจนกว่าเครื่องจะหยุดทำงาน จากนั้นถึงสามารถเปิดหรือยกส่วนหัวของเครื่องขึ้นได้

ระบบการทำงานของ VERTUO

ประเภทแคปซูลที่รองรับ

S	M	L	XL
เอสเพรสโซ	ดับเบิลเอสเพรสโซ	มัท	อัลโต, โคลด์บริว
40 มล. / 1.35 ออนซ์	80 มล. / 2.7 ออนซ์	230 มล. / 7.77 ออนซ์	355 มล. / 12 ออนซ์
	แกรนลุงโก		คาราฟ
	150 มล. / 5.07 ออนซ์		535 มล. / 18.8 ออนซ์

อุปกรณ์เสริมที่รองรับ



✓
อุปกรณ์เสริมที่รองรับ



เอสเพรสโซ



ดับเบิลเอสเพรสโซ



แกรนลุงโก



มัท (S)



มัท (M)



แก้ว

✗
อุปกรณ์เสริมที่ไม่เหมาะสม



มัท (L)



คาราฟ

ค้นหา คอลเลคชันอุปกรณ์เสริมทั้งหมดของเราที่ www.nespresso.com/th

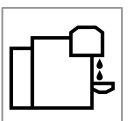
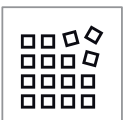

เปิด/ปิด

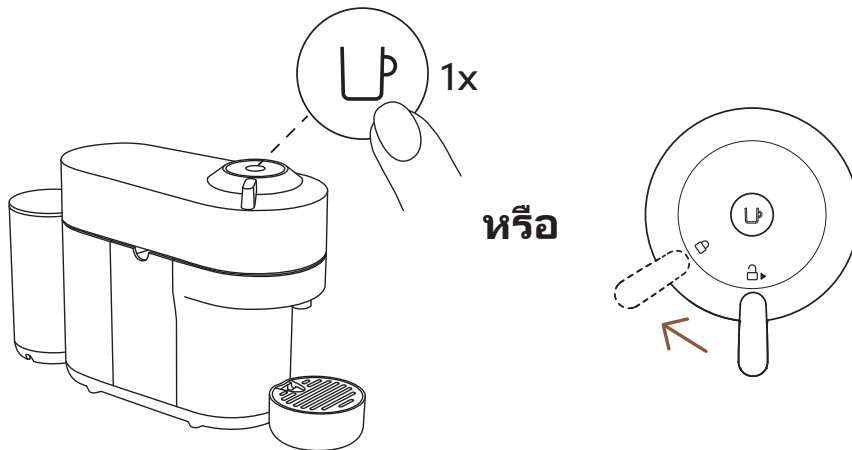

เปิด

เมื่อเสียบปลั๊กเครื่องเรียบร้อยแล้ว ให้เปิดเครื่องโดยกดปุ่มทำกาแฟ 1 ครั้งหรือบิดคันโยกไปยังตำแหน่งล็อก (หัวของเครื่องอยู่สถานะปิด)

- i** ไฟที่ปุ่มทำกาแฟจะกะพริบประมาณ 30 วินาที ในขณะที่เครื่องกำลังทำความร้อน เมื่อไฟสว่างคงที่แสดงว่าเครื่องพร้อมใช้งาน

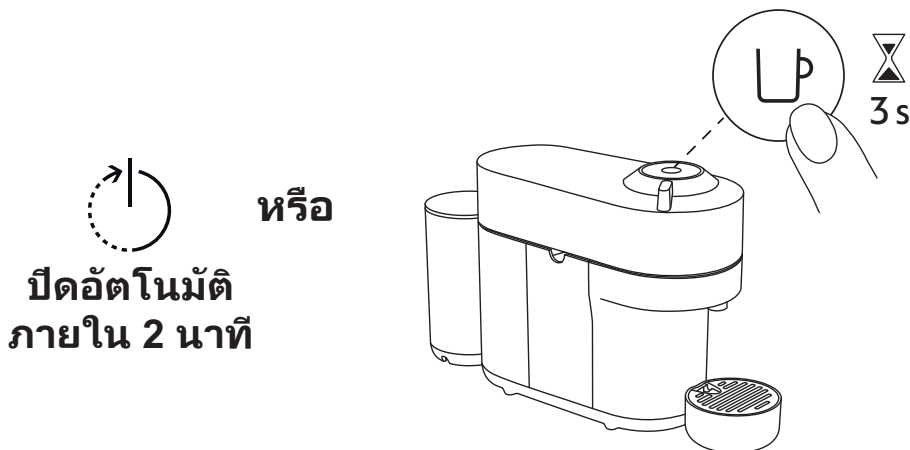

ปิด

เพื่อเป็นการประหยัดพลังงาน เครื่องจะปิดโดยอัตโนมัติหลังจากไม่ได้ใช้งานเป็นเวลา 2 นาที

- i** เครื่องสามารถ “ปิด” โดยผู้ใช้งานได้ตลอดเวลา(เมื่อไม่ได้ใช้งาน) โดยกดปุ่มทำกาแฟค้างไว้ 3 วินาที

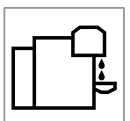

การเชื่อมต่อ

ทำไมคุณควรเชื่อมต่อเครื่อง VERTUO POP ของคุณ



สิทธิประโยชน์ของการเชื่อมต่อเครื่อง VERTUO POP ของคุณ

- **เลือกกาแฟที่เหมาะสมกับคุณ:** รับข้อมูลข่าวสารเกี่ยวกับนวัตกรรมการทำกาแฟล่าสุดของ **Nespresso** โดยอัปเดตเคล็ดลับต่างๆของเครื่องชงกาแฟของคุณอยู่เสมอ
- **คำแนะนำจากผู้เชี่ยวชาญ:** รองรับการสนับสนุนและวิดีโอการใช้งานเครื่องอย่างง่าย เพื่อติดตามและรวบรวมประสบการณ์การดื่มกาแฟของคุณผ่านสมาร์ทโฟน
- **การดูแลเครื่อง:** รับการแจ้งเตือนทันทีเกี่ยวกับวิธีการและรอบเวลาในการซ่อมบำรุงรักษาเครื่องของคุณด้วยคำแนะนำขั้นตอนอย่างง่าย เกี่ยวกับการขจัดคราบตะกอน, การกลั้วล้าง, การทำความสะอาด ฯลฯ

วิธีการเชื่อมต่อเครื่อง VERTUO POP ของคุณ?

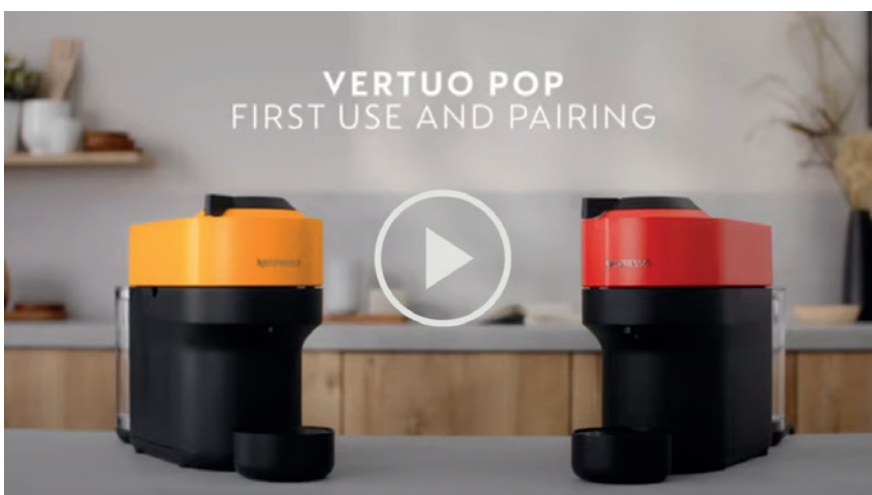



1 ดาวน์โหลดหรืออัปเดต **Nespresso**. เปิดใช้งานผ่านแอปพลิเคชัน **Nespresso** บนสมาร์ตโฟนหรือแท็บเล็ตของคุณ กดไอคอนที่รูปเครื่องชงกาแฟที่ด้านบนขวาของหน้าจอ

หมายเหตุ: เพื่อประสิทธิภาพสูงสุดและประสบการณ์ที่ดี เราขอแนะนำให้เชื่อมต่อเครื่องของคุณกับเราเตอร์ Wi-Fi (Wi-Fi router) แทนการใช้ฮอตสปอต (hotspot) ของสมาร์ตโฟน

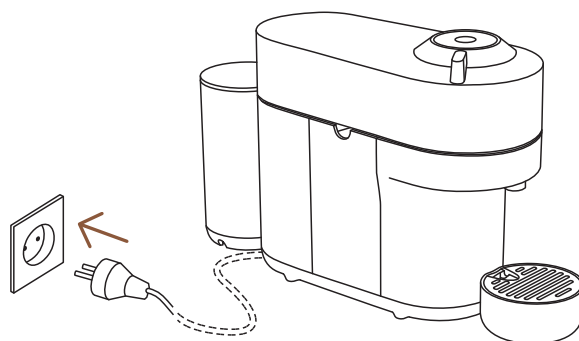

2 เสียบปลั๊กไฟ



3 ทำตามคำแนะนำผ่านแอปพลิเคชัน **Nespresso**

ข้อควรระวัง: ก่อนใช้เครื่องชงกาแฟ โปรดอ่านข้อควรระวังด้านความปลอดภัยเพื่อหลีกเลี่ยงความเสี่ยงจากไฟฟ้าช็อตและไฟไหม้ที่อาจเกิดขึ้น. โปรดตรวจสอบการต่อสายดินก่อนเสียบปลั๊กเครื่องชงกาแฟเข้ากับเต้ารับ

* AppStore® เป็นเครื่องหมายการค้าของ Apple Inc. ซึ่งจดทะเบียนในสหรัฐอเมริกาและประเทศอื่นๆ
 ** Google Play และโลโก้ Google Play เป็นเครื่องหมายการค้าของ Google LLC



การปิดการใช้งานบลูทูธและ WI-FI ของเครื่อง

เครื่องมาพร้อมกับโมดูลการเชื่อมต่อซึ่งเปิดใช้งานโดยค่าเริ่มต้น ช่วยให้เข้าถึงคุณสมบัติเพิ่มเติม ยกเว้นระดับประสบการณ์การดื่มกาแฟของคุณ หากต้องการปิดใช้งานโมดูลการเชื่อมต่อ ให้ทำตามขั้นตอนเหล่านี้:

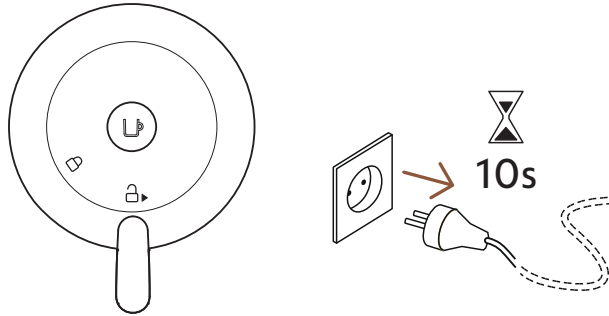

- 1** เมื่อปิดเครื่องและบิดก้านล๊อคไปยังตำแหน่งปลดล๊อค ให้ถอดปลั๊กออก เป็นเวลาอย่างน้อย 10 วินาที

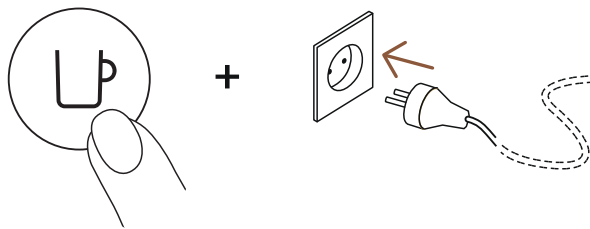

- 2** กดปุ่มทำกาแฟค้างไว้ในขณะเสียบปลั๊ก
ปุ่มทำกาแฟจะกะพริบเป็นไฟสีส้ม เพื่อยืนยันว่าโมดูลการเชื่อมต่อถูกปิดใช้งานแล้ว

- i** ทำตามขั้นตอนเดิม เพื่อตั้งค่าโมดูลการเชื่อมต่ออีกครั้ง กดปุ่มทำกาแฟจะกะพริบเป็นไฟสีขาวเพื่อยืนยันว่าโมดูลได้รับการเปิดใช้งานอีกครั้ง

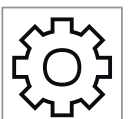
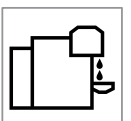
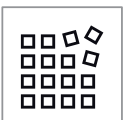

ขั้นตอนแรก

การล้างทำความสะอาดครั้งแรก

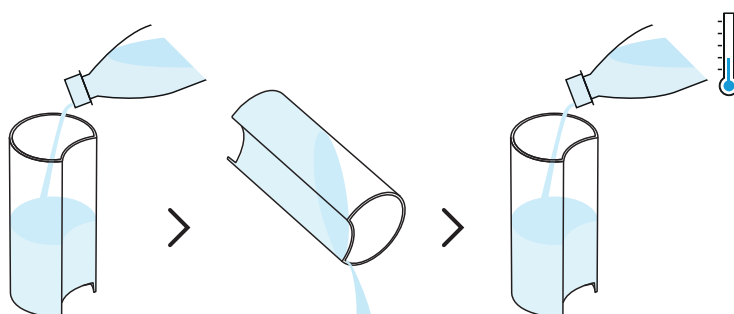

- 1 การล้างและทำความสะอาดถังน้ำและฝาปิดครั้งแรกก่อนเติมน้ำดื่มสะอาด

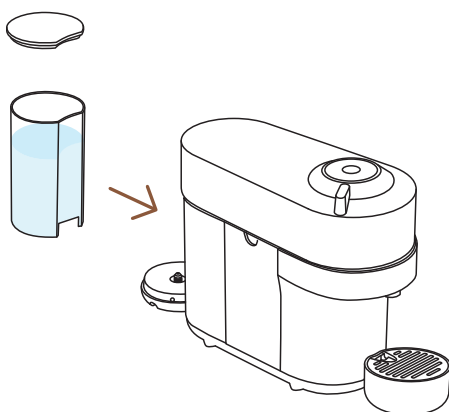

- 2 ปิดฝาทิ้งน้ำและวางถังน้ำเข้าที่และตรวจดูให้แน่ใจว่าได้ติดตั้งถังน้ำตรงตำแหน่งที่ถูกต้อง

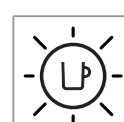
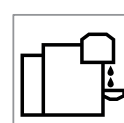
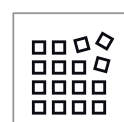
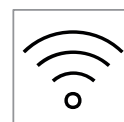

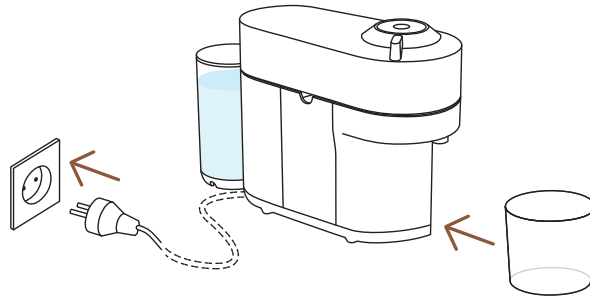

- 3** เสียบปลั๊กไฟ ถอดฐานรองแก้วออก และวางภาชนะเปล่า (ขนาดอย่างน้อย 1 ลิตร / 34 ออนซ์) ไว้ช่องปล่อยกาแฟ

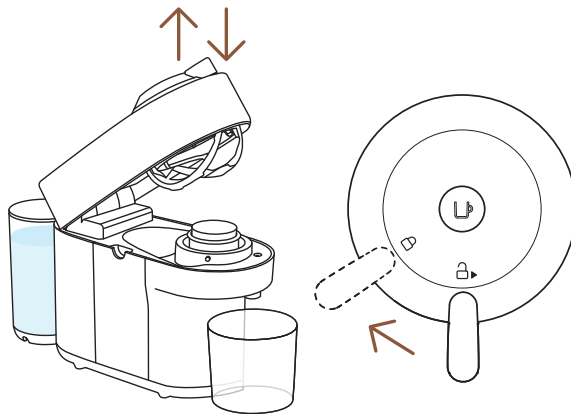

- 4** เปิดและปิดส่วนหัวของเครื่อง ตรวจสอบให้แน่ใจว่าคันโยกอยู่ในตำแหน่งล็อก

- i** ไฟที่ปุ่มทำกาแฟจะกระพริบในขณะที่เครื่องกำลังทำความร้อน จะใช้เวลาประมาณ 30 วินาที เมื่อไฟที่ปุ่มทำกาแฟเปลี่ยนเป็นสว่างคงที่ แสดงว่าเครื่องพร้อมใช้งาน ตรวจสอบให้แน่ใจว่าไม่มีแคปซูลอยู่ในเครื่อง

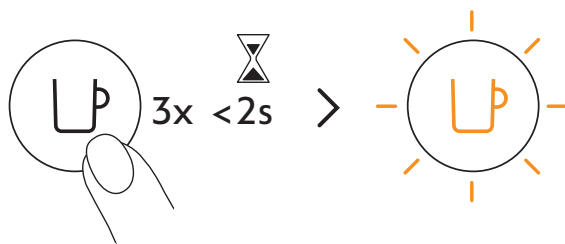

- 5** กดปุ่มทำกาแฟ 3 ครั้ง ภายใน 2 วินาที เพื่อเริ่มกระบวนการล้าง โดยไฟที่ปุ่มทำกาแฟจะกระพริบเป็นสีส้ม เมื่อขั้นตอนเสร็จสิ้นไฟที่ปุ่มทำกาแฟจะกลับมาสว่างคงที่ แสดงว่าการล้างเสร็จสมบูรณ์

- i** ใช้เวลาอย่างน้อยกว่า 2 นาทีก่อนที่กระบวนการล้างจะเริ่มขึ้นและมีน้ำเริ่มไหลออกมา ขั้นตอนนี้อาจใช้เวลาถึง 7 นาที

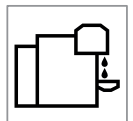
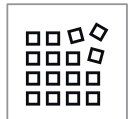

การเตรียมเครื่องดื่ม (กาแฟ)

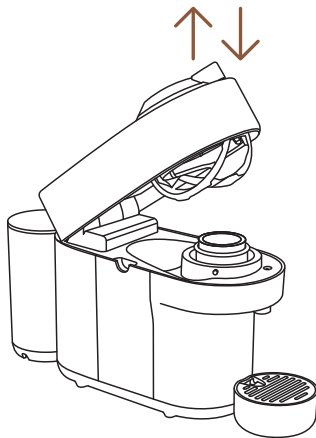

1 เปิดและปิดส่วนหัวของเครื่อง

- i** ไฟที่ปุ่มทำกาแฟจะกะพริบในขณะที่เครื่องกำลังทำความร้อน เมื่อไฟที่ปุ่มทำกาแฟนิ่งหรือสว่างคงที่แสดงว่าเครื่องพร้อมใช้งาน

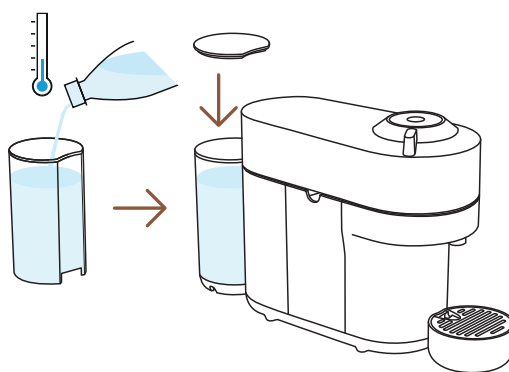

2 เติมน้ำดื่มสะอาดลงในถังน้ำและวางกลับเข้าที่เดิม



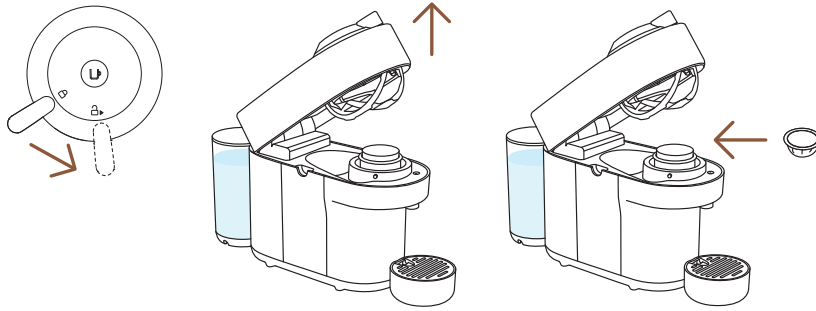

- 3** ปลดล็อกและยก/เปิดส่วนหัวของเครื่องทำกาแฟ ขึ้น แล้วใส่แคปซูลVertuo ในลักษณะโดมคว่ำลง

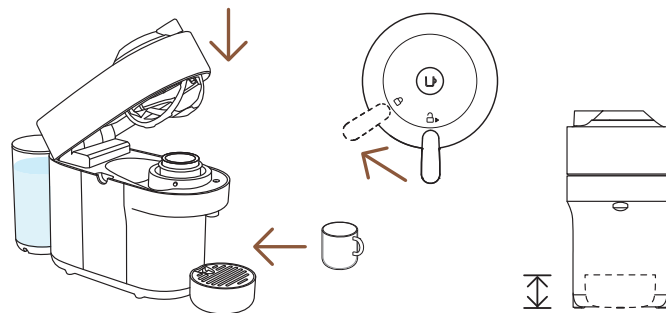

- 4** ปิด/กดส่วนหัวของเครื่องลงและหมุนก้านล็อกไปทางซ้ายจนถึงตำแหน่งล็อก แล้ววางแก้วกาแฟใต้ช่องปล่อยกาแฟ ที่วางแก้วสามารถปรับระดับให้เหมาะกับขนาดแก้วกาแฟของคุณได้

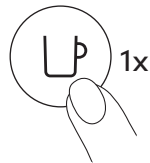

- 5** เริ่มการสกัดกาแฟ โดยกดปุ่มทำกาแฟ 1 ครั้ง

ข้อควรระวัง: เพื่อการใช้งานเครื่องที่เหมาะสม ห้ามเปิดหรือยกส่วนหัวของเครื่องชงกาแฟในขณะที่เครื่องกำลังทำกาแฟ ให้รอจนกว่าสถานะไฟที่ปุ่มทำกาแฟกลับไปเป็นสีขาวสว่างคงที่ หากคุณต้องการหยุดการทำกาแฟ ให้กดปุ่มทำกาแฟหนึ่งครั้งและรอจนกว่าเครื่องจะหยุดทำงาน จากนั้นถึงสามารถเปิดหรือยกส่วนหัวของเครื่องขึ้นได้

- i** เนื่องจากกระบวนการสกัดกาแฟของเครื่องนี้ ประกอบไปด้วยการอ่านรหัสบาร์โค้ดที่แคปซูล, การทำให้กาแฟเปียกก่อนเริ่มสกัด และเวลาในการสกัดกาแฟ ดังนั้นจะใช้เวลาสักครู่ก่อนที่กาแฟจะเริ่มไหล เครื่องจะจดจำแคปซูลที่ใส่เข้าไปโดยอัตโนมัติ และเลือกพารามิเตอร์การเตรียมกาแฟ และขนาดแก้วที่กำหนดโดยผู้เชี่ยวชาญด้านกาแฟของNespresso เพื่อสกัดกาแฟออกมาให้มีความหอมและรสชาติที่ดีที่สุด

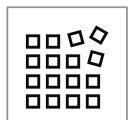

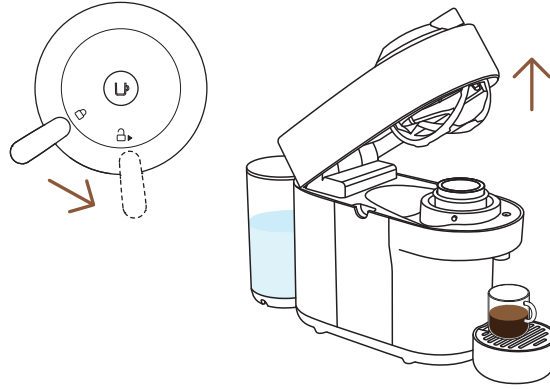

- 6** เมื่อกาแฟหยุดสกัด ให้ยก/เปิดส่วนหัวเครื่องขึ้น โดยหมุนก้าน ล็อคไปทางขวาไปยังตำแหน่งปลดล็อค เพื่อนำแคปซูลกาแฟ ออกโดยอัตโนมัติและเพลิดเพลลิ่งกับกาแฟของคุณ



- 7** อย่าลืมรีไซเคิลแคปซูลNespresso ของคุณ*

* เครื่องนี้เป็นของเนสเพรสโซ ซึ่งสามารถรีไซเคิลได้ สอบถามรายละเอียดเพิ่มเติมเกี่ยวกับการรีไซเคิลแคปซูลกาแฟได้ที่ www.nespresso.com/th

ค้นหา โหมดการสร้างสรรค์กาแฟของเรา



ด้วยเครื่องชงกาแฟNespressoนี้ มีฟังก์ชันเฉพาะในการสกัดกาแฟเพื่อสร้างสูตรหรือเมนูกาแฟของคุณ

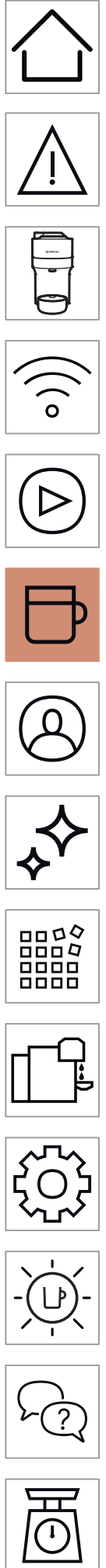

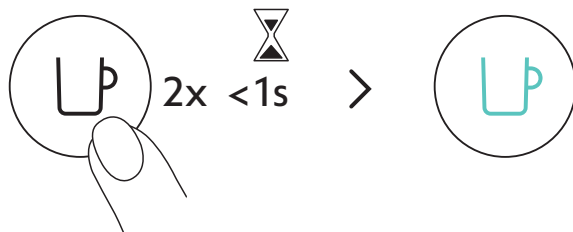

เมื่อเปิดเครื่อง ให้กดปุ่มทำกาแฟสองครั้งต่อเนื่อง ไฟจะกะพริบเป็นสีฟ้าครามและกาแฟของคุณจะเข้มข้น, ปรับรสชาติกาแฟให้เหมาะสมกับสูตรที่มีส่วนผสมเพิ่ม (นม ครีมเทียม น้ำแข็ง...) เพื่อสร้างประสบการณ์การดื่มกาแฟที่หาที่เปรียบมิได้

40 มล. / 1.35 ออนซ์	80 มล. / 2.7 ออนซ์	150 มล. / 5.07 ออนซ์	230 มล. / 7.77 ออนซ์	355 มล. / 12 ออนซ์	535 มล. / 18.8 ออนซ์
✓	✓	✓	✓	✗	✗
25 มล. / 0.85 ออนซ์	40 มล. / 1.35 ออนซ์	40 มล. / 1.35 ออนซ์	80 มล. / 2.7 ออนซ์		

เพื่อให้ได้รับความเพลิดเพลินกับประโยชน์อย่างเต็มที่ เราขอแนะนำให้สกัดกาแฟขนาดต่างๆ โดยใช้แก้วขนาดต่างๆที่เหมาะสมตามที่เรแนะนำเท่านั้น เพื่อให้ได้ผลลัพธ์ที่ดีที่สุด เราไม่แนะนำให้สกัดกาแฟขนาด XL (Alto Ambrato, Alto Onice), Cold Brew Style & Carafe Pour Over Style ด้วยโหมดนี้

หมายเหตุ: อาจจำเป็นต้องอัปเดตเครื่องของคุณผ่านแอปNespresso เพื่อเปิดใช้งานโหมดนี้



ค้นหา วิธีอัปเดตเครื่องของคุณด้วยผลิตภัณฑ์ Aeroccino ของเราที่ www.nespresso.com/th

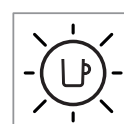
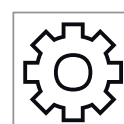
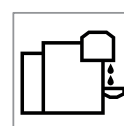
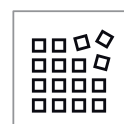
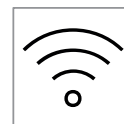

ปรับปริมาณกาแฟของคุณ

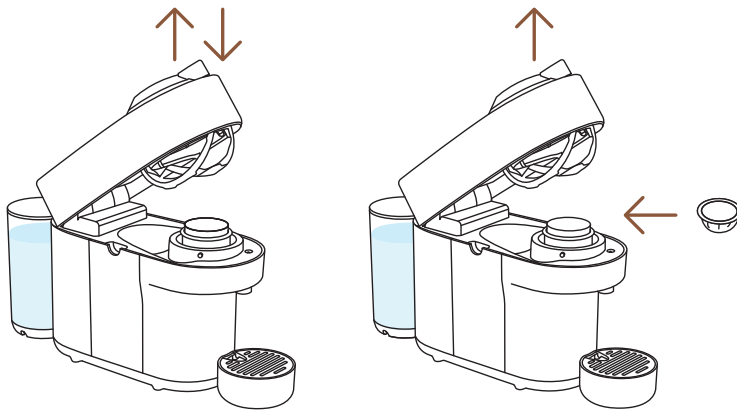

- 1** เมื่อเครื่องอยู่ในสถานะเปิด ให้ยกหัวเครื่องชงกาแฟขึ้นและใส่แคปซูลที่คุณต้องการปรับปริมาณเข้าไป

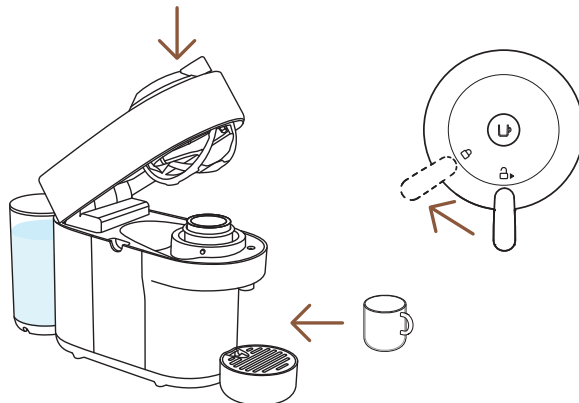

- 2** กด/ปิดส่วนหัวของเครื่อง แล้วหมุนก้านล็อคไปทางซ้ายไปยังตำแหน่งล็อค แล้ววางแก้วใต้ช่องปล่อยกาแฟ

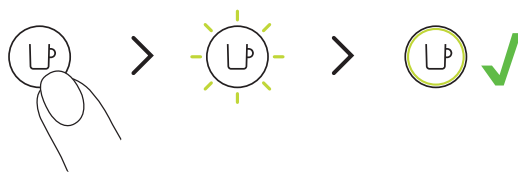

- 3** กดปุ่มทำกาแฟค้างไว้ รอสักพักประมาณ 2-3 วินาที ก่อน จากนั้นปรับปริมาณกาแฟจนได้ปริมาณที่ต้องการ ระหว่างการตั้งค่า การปรับปริมาณกาแฟ ปริมาณน้ำใหม่จะถูกบันทึกตามประเภทของแคปซูลกาแฟที่ใช้เรียบร้อยแล้ว

- i** การตั้งโปรแกรมการปรับปริมาณกาแฟจะตั้งค่าตามขนาดของแคปซูล แต่ละประเภท ขนาดกาแฟต่อแก้ว สามารถตั้งโปรแกรมการปรับปริมาณได้ตั้งแต่ 20 มล. / 0.7 ออนซ์ ถึง 535 มล. / 18 ออนซ์

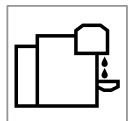
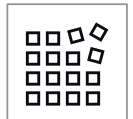

ข้อควรระวัง: เพื่อการใช้งานเครื่องที่เหมาะสม ห้ามเปิดหรือยกส่วนหัวของเครื่องชงกาแฟในขณะที่เครื่องกำลังทำกาแฟ ให้รอจนกว่าสถานะไฟที่ปุ่มทำกาแฟกลับไปเป็นสีขาวสว่างคงที่ หากคุณต้องการหยุดการทำกาแฟ ให้กดปุ่มทำกาแฟหนึ่งครั้งและรอจนกว่าเครื่องจะหยุดทำงาน จากนั้นถึงสามารถเปิดหรือยกส่วนหัวของเครื่องขึ้นได้

ข้อสังเกต: เมื่อผู้ใช้งานตั้งโปรแกรมการปรับปริมาณกาแฟเฉพาะของผู้ใช้งาน ทุกครั้งที่ใส่แคปซูลประเภทนั้นลงในเครื่อง การสกัดกาแฟจะหยุดที่ปริมาณกาแฟที่ผู้ใช้งานตั้งโปรแกรมไว้ หากคุณต้องการกลับมาใช้พารามิเตอร์การสกัดเดิม(ค่าเริ่มต้น) โปรดดูหน้า “คืนค่าสู่การตั้งค่าจากโรงงาน”

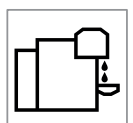

การทำความสะอาด

ทำความสะอาดเครื่องเป็นประจำอย่างน้อยทุกเดือน เมื่อคุณพบเศษหรือกากกาแฟตกค้างภายในส่วนหัวของเครื่องหรือหลังจากไม่ได้ใช้งานเป็นเวลานาน

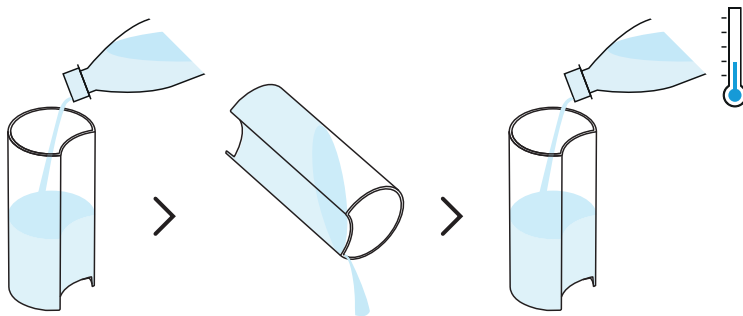

1 ล้างและทำความสะอาดถังน้ำและฝาปิด ก่อนเติมน้ำดื่มสะอาด

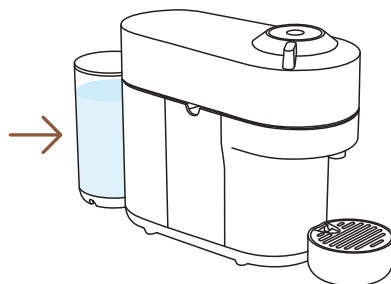

2 ใส่ถังน้ำกลับเข้าที่ตำแหน่งเดิมที่ตัวเครื่อง



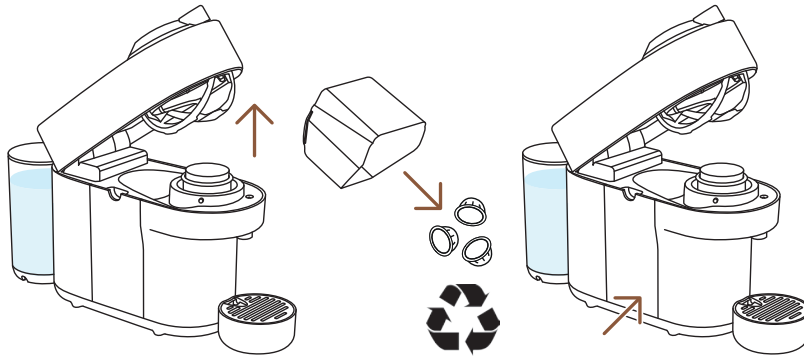

- 3** เมื่อเปิดเครื่อง ให้ปลดล็อกและยก/เปิดส่วนหัวของเครื่องขึ้น และนำแคปซูลที่ใช้แล้วออก นำแคปซูลที่ใช้แล้วออกและล้าง ถังบรรจุแคปซูลที่ใช้แล้วและถาดรองน้ำหยด แล้วใส่กลับเข้าที่เดิม อย่าลืมรีไซเคิลแคปซูล Nespresso ของคุณ*

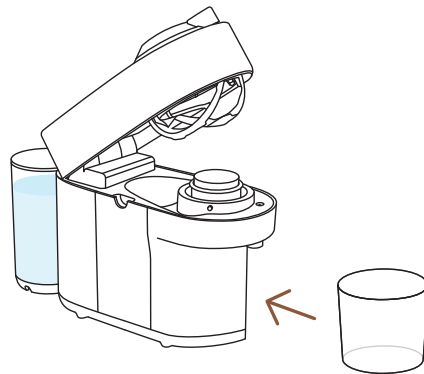

- 4** ถอดฐานรองแก้วออกและวางภาชนะเปล่า (อย่างน้อย 1 ลิตร / 34 ออนซ์) ไว้ใต้ช่องปล่อยกาแฟ

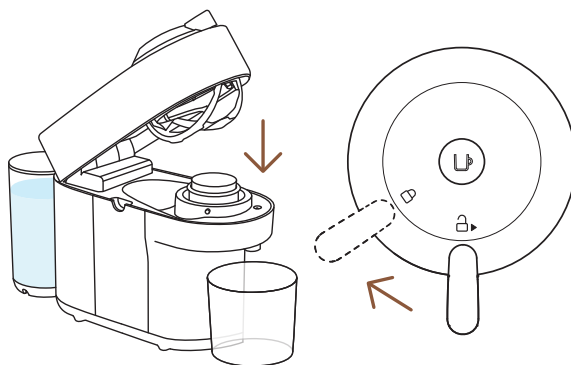

- 5** กด/ปิดส่วนหัวของเครื่องลงและบิดก้านล็อกไปทางซ้ายไปยังตำแหน่งล็อก ตรวจสอบให้แน่ใจว่าไม่มีแคปซูลอยู่ในเครื่อง ก่อนที่จะเริ่มขั้นตอนการล้าง

* เครื่องนี้เป็นของเนสเพรสโซ่ ซึ่งสามารถรีไซเคิลได้ สอบถามรายละเอียดเพิ่มเติมเกี่ยวกับการรีไซเคิลแคปซูลกาแฟได้ที่ www.nespresso.com/th

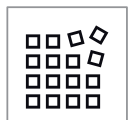

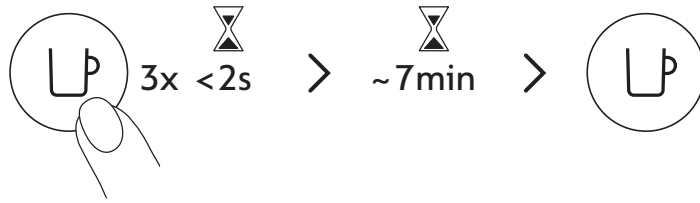

- 6** กดปุ่มทำกาแฟ 3 ครั้งภายใน 2 วินาที เพื่อเริ่มการล้าง ในระหว่างการล้างไฟจะเป็นไฟสีส้มกะพริบ ขั้นตอนการล้างจะเสร็จสิ้นโดยอัตโนมัติ
- i** ควรใช้เวลาน้อยกว่า 2 นาทีก่อนที่กระบวนการล้างจะเริ่มขึ้นและน้ำเริ่มไหล การดำเนินการนี้อาจใช้เวลาถึง 7 นาที และจะหยุดโดยอัตโนมัติเมื่อรอบการทำงานเสร็จสิ้น สามารถหยุดขั้นตอนได้ตลอดเวลาโดยกดปุ่มทำกาแฟ

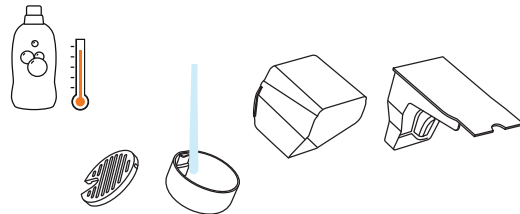

- 7** ล้างกล่องบรรจุแคปซูลที่ใช้แล้ว ถูานร่องแก้ว และถาดรองน้ำ ด้วยน้ำและน้ำยาทำความสะอาดแบบอ่อนไร้กลิ่น

คำเตือน: ห้ามใช้สารทำความสะอาดที่แรงหรือมีฤทธิ์กัดกร่อนหรือตัวทำละลายใดๆ ห้ามล้างหรือใส่เครื่องลงในเครื่องล้างจาน ห้ามนำอุปกรณ์หรือส่วนหนึ่งของอุปกรณ์ไปจุ่มน้ำโดยเด็ดขาด

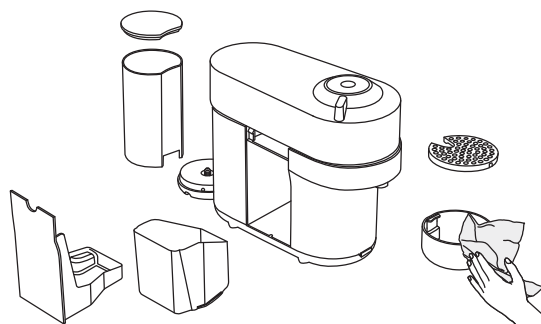

- 8** เช็ดเครื่องให้แห้งด้วยผ้าใหม่ที่สะอาด

คำเตือน: ทำความสะอาดช่องปล่อยกาแฟเป็นประจำด้วยผ้าสะอาดชุบน้ำหมาดๆ ใช้ผ้าที่มีขนนุ่มทำความสะอาดเครื่องเสมอ

ข้อสังเกต: อาจมีน้ำหลงเหลือหรือสะสมภายในส่วนหัวของเครื่องระหว่างการทำความสะอาด หากสิ่งนี้เกิดขึ้น โปรดเช็ดส่วนที่มองเห็นให้แห้งด้วยผ้าแห้งที่สะอาด

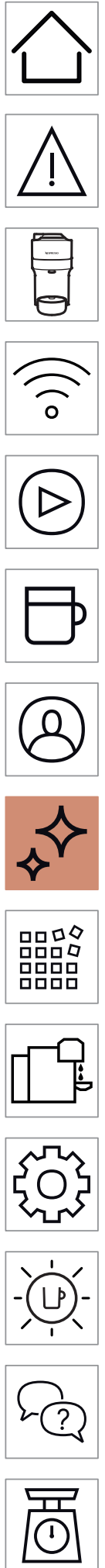

การขจัดคราบตะกรัน

การขจัดคราบตะกรันจะทำให้เครื่องทำงานได้อย่างถูกต้องตลอดอายุการใช้งาน และจะทำให้ประสบการณ์การดื่มกาแฟของคุณเหมือนกับวันแรก เครื่องของคุณจะแจ้งเตือนด้วยไฟกะพริบสีส้ม 3 ครั้งก่อนจะเป็นสีขาวนิง เมื่อจำเป็นต้องล้างตะกรัน



i ขั้นตอนการขจัดตะกรันใช้เวลาประมาณ 20 นาทีและไม่สามารถหยุดกระบวนการหรือขัดจังหวะได้

หมายเหตุ: โปรดอ่านคำแนะนำและทำความเข้าใจในการขจัดคราบตะกรันอย่างถ่องแท้ก่อนที่จะเริ่ม

สิ่งที่ต้องเตรียม:

- สามารถสั่งซื้อน้ำยาขจัดตะกรันที่ www.nespresso.com/th
- ภาชนะเปล่า (ขนาด 1 ลิตร / 34 ออนซ์)

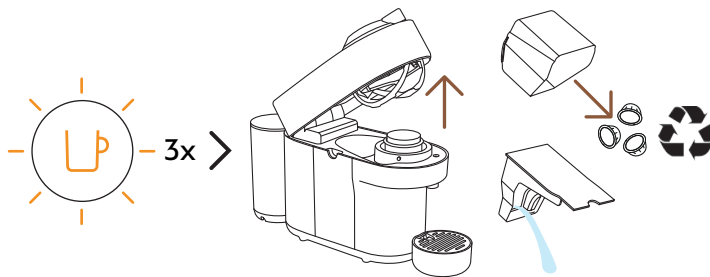

1 โดยปุ่มทำกาแฟจะกะพริบเป็นสีส้ม 3 ครั้ง: ปลดลิ้นและยก/เปิดส่วนหัวของเครื่องขึ้นเพื่อนำแคปซูลที่ใช้แล้วออก ล้างภาชนะกรองบรรจุแคปซูลที่ใช้แล้วและถอดรอกน้ำ แล้ววางกลับเข้าที่อย่างสริมรีไซเคิลแคปซูล Nespresso ของคุณ*

* เครื่องนี้เป็นของเนสเพรสโซ ซึ่งสามารถรีไซเคิลได้ สอบถามรายละเอียดเพิ่มเติมเกี่ยวกับการรีไซเคิลแคปซูลกาแฟได้ที่ www.nespresso.com/th

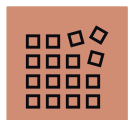

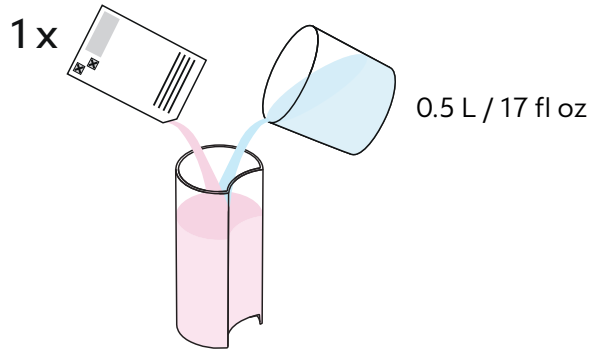

- 2** เติมน้ำ 0.5 ลิตร / 17 ออนซ์ลงในถังน้ำ และเติมน้ำยาขจัดคราบตะกรัน Nespresso 1 ถุง

ข้อควรระวัง: โปรดทราบว่าน้ำยาขจัดคราบตะกรันอาจเป็นอันตรายได้ หลีกเลี่ยงการสัมผัสกับดวงตา ผิวหนัง และพื้นผิวต่างๆ

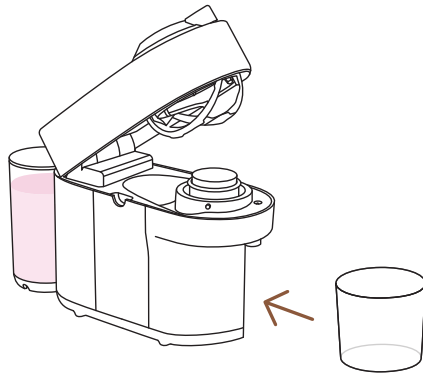

- 3** ถอดฐานรองแก้วออกและวางภาชนะเปล่า (อย่างน้อย 1 ลิตร / ชั้น 34 ออนซ์) ไว้ใต้ช่องปล่อยกาแฟ

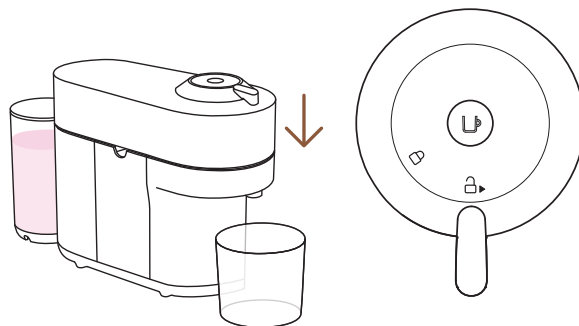

- 4** เมื่อเครื่องเปิดอยู่ ให้กด/ปิดส่วนหัวของเครื่องลงและหมุนก้าน ล็อคไปยังตำแหน่งปลดล็อค

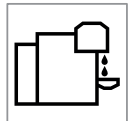

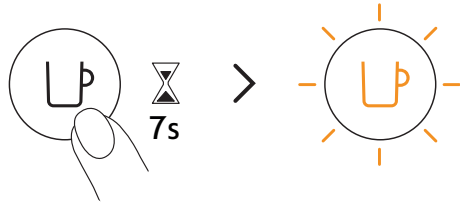

5 กดปุ่มค้างไว้อย่างน้อย 7 วินาทีหรือจนกว่าคุณจะเห็นไฟดับ ปุ่มทำกาแฟจะเริ่มกะพริบเป็นสีส้มอย่างรวดเร็ว

ข้อควรระวัง: ขั้นตอนนี้คุณมีเวลา 45 วินาทีในการเข้าสู่โหมดขจัดคราบตะกรัน มิฉะนั้นเครื่องจะกลับสู่โหมดการสกัดกาแฟ

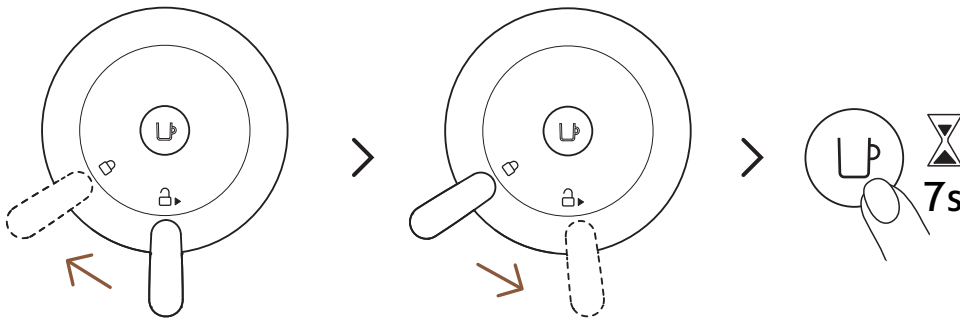

6 ล็อคส่วนหัวของเครื่องโดยหมุนก้านล็อคไปทางซ้ายจนถึงสัญลักษณ์ล็อค จากนั้นปลดล็อคก้านล็อคไปยังตำแหน่งปลดล็อค กดปุ่มทำกาแฟค้างไว้อีกครั้งประมาณ 7 วินาทีหรือจนกว่าไฟจะดับ ปุ่มทำกาแฟจะเริ่มกะพริบเป็นสีส้มอย่างรวดเร็ว

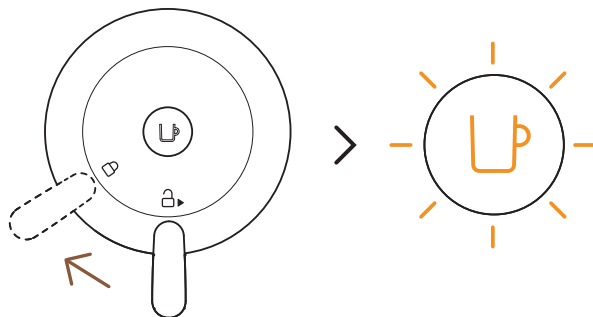

7 ในการเข้าสู่โหมดขจัดคราบตะกรัน ให้ล็อคเครื่องโดยก้านล็อคไปทางซ้ายไปยังตำแหน่งล็อค ไฟจะยังคงกะพริบเป็นสีส้มอย่างรวดเร็ว นี่เป็นข้อบ่งชี้ว่าคุณเข้าสู่โหมดการขจัดคราบตะกรันแล้ว

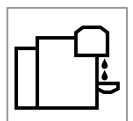

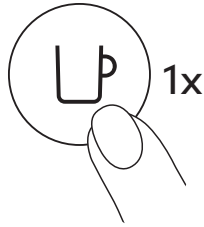

8 กดปุ่มทำกาแพหนึ่งครั้งเพื่อเริ่มกระบวนการขจัดคราบตะกรัน ไฟจะกะพริบเป็นสีส้มอย่างต่อเนื่องตลอดกระบวนการ

i เครื่องจะหยุดโดยอัตโนมัติ เมื่อขั้นตอนแรกของการขจัดตะกรันเสร็จสิ้น

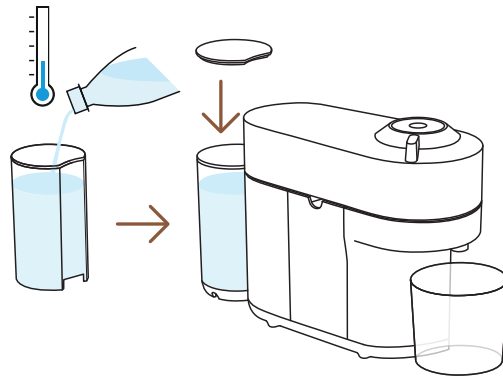

9 เมื่อสิ้นสุดกระบวนการขจัดคราบตะกรัน จากนั้นถึงเวลาล้างเครื่องด้วยน้ำสะอาด ล้างถังน้ำและถาดรองน้ำให้สะอาด เติมน้ำดื่มสะอาดลงในถังน้ำแล้วใส่กลับเข้าที่ เหน้ในภาชนะสำหรับล้างออก แล้ววางกลับเข้าไปใต้ช่องปล่อยกาแพ

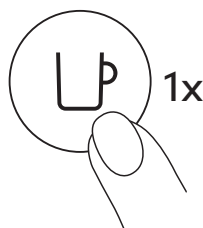

10 กดปุ่มทำกาแพเพื่อล้างเครื่อง เมื่อไฟที่ปุ่มหยุดกะพริบอย่างรวดเร็วและกลายเป็นสว่างคงที่ จะถือว่าขั้นตอนการขจัดคราบตะกรันเสร็จสิ้น

i เครื่องจะหยุดโดยอัตโนมัติ เมื่อขั้นตอนการขจัดคราบตะกรันเสร็จสิ้น

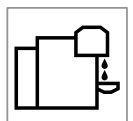

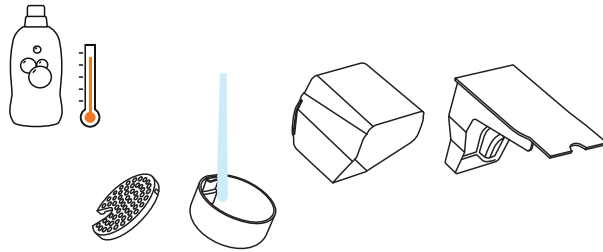

11 ล้างกล่องบรรจุแคปซูลที่ใช้แล้วและฐานรองแก้ว และถาดรองน้ำด้วยน้ำและน้ำยาล้างทำความสะอาดแบบอ่อนไว้ก่ลิน

ข้อควรระวัง: ห้ามใช้สารทำความสะอาดที่แรงหรือมีฤทธิ์กัดกร่อนหรือตัวทำละลายใดๆ ห้ามล้างหรือใส่เครื่องลงในเครื่องล้างจาน ห้ามนำอุปกรณ์หรือส่วนหนึ่งของอุปกรณ์ไปจุ่มน้ำโดยเด็ดขาด

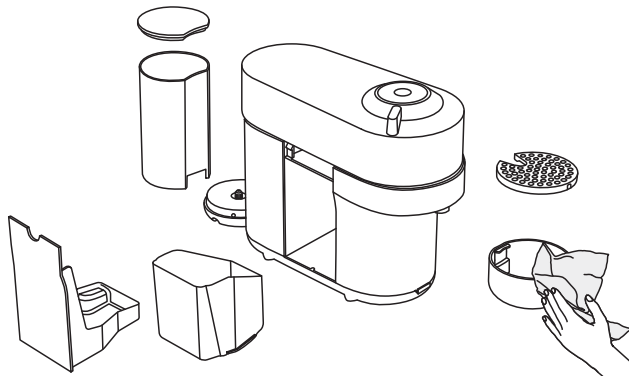

12 เช็ดเครื่องให้แห้งด้วยผ้าใหม่ที่สะอาด ปล่อยให้เครื่องแห้งเป็นเวลา 10 นาทีก่อนใช้งาน

ข้อสังเกต: อาจมีน้ำหลงเหลือหรือสะสมภายในส่วนหัวของเครื่องระหว่างการทำความสะอาด หากสิ่งนี้เกิดขึ้น โปรดเช็ดส่วนที่มองเห็นให้แห้งด้วยผ้าแห้งที่สะอาด หากสิ่งนี้เกิดขึ้น โปรดเช็ดส่วนที่มองเห็นให้แห้งด้วยผ้าแห้งที่สะอาด

หมายเหตุ: เครื่องสามารถเข้าสู่โหมดการขัดตะกรันได้หลังจากสัปดาห์ 30 แก้วขึ้นไป

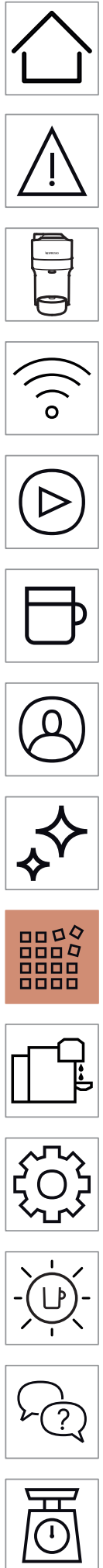

การถ่ายน้ำออกจากระบบ

การถ่ายน้ำออกจากระบบ เป็นกระบวนการล้างระบบก่อนที่จะไม่ได้ใช้งานเครื่องเป็นระยะเวลานานหรือก่อนส่งเครื่องไปซ่อม เพื่อป้องกันน้ำค้างในระบบ

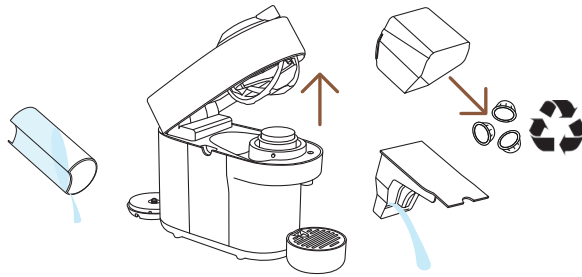

- 1 ล้างถังน้ำ. ยก/เปิดส่วนหัวของเครื่องขึ้นเพื่อนำแคปซูลที่ใช้แล้วออก ล้างภาชนะกักเก็บบรรจุแคปซูลที่ใช้แล้วและถาดรองน้ำอย่าลืมรีไซเคิลแคปซูลNespresso ของคุณ*

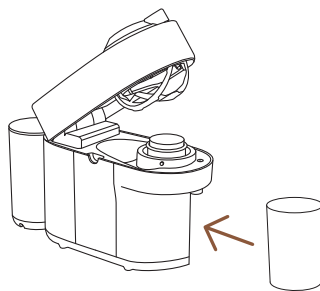

- 2 วางกลับเข้าที่ตำแหน่งเดิมของเครื่อง ถอดฐานรองแก้วออก และวางภาชนะเปล่า (0.5 ลิตร / 17 ออนซ์) ไว้ใต้ช่องปล่อยกาแฟ

* เครื่องนี้เป็นของเนสเพรสโซ่ ซึ่งสามารถรีไซเคิลได้ สอบถามรายละเอียดเพิ่มเติมเกี่ยวกับการรีไซเคิลแคปซูลกาแฟได้ที่ www.nespresso.com/th



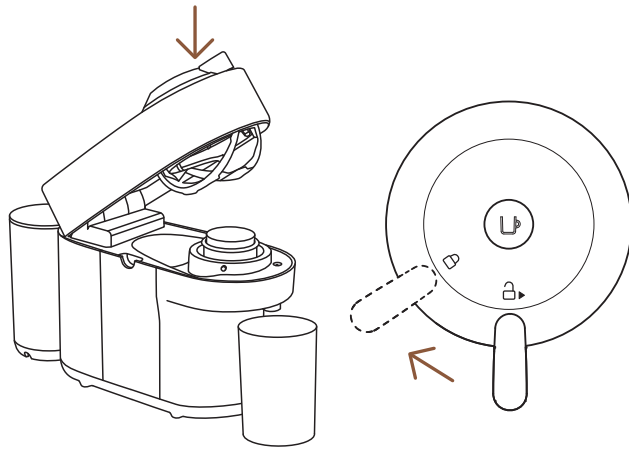

3 เมื่อเสียบปลั๊กและเปิดเครื่องแล้ว ให้หมุนก้านล็อคไปยังตำแหน่ง ล็อค

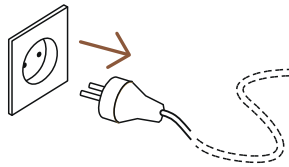

4 ถอดปลั๊กเครื่อง

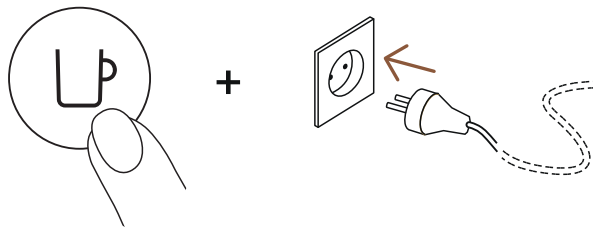

5 กดปุ่มทำกาแฟค้างไว้ขณะเสียบปลั๊กเครื่อง

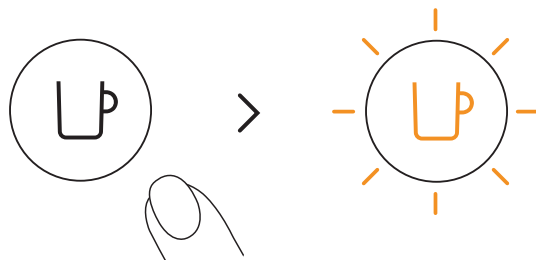

6 เลิกกดปุ่มทำกาแฟ ไฟที่ปุ่มทำกาแฟจะกะพริบเป็นสีส้มและ กระบวนการถ่ายน้ำออกจากระบบจะเริ่มขึ้น

i เครื่องจะใช้เวลาประมาณ 30 วินาทีในการดำเนินการให้เสร็จสิ้น เครื่อง จะปิดโดยอัตโนมัติเมื่อถ่ายน้ำออกจากระบบหมด



คืนค่าสู่การตั้งค่าจากโรงงาน

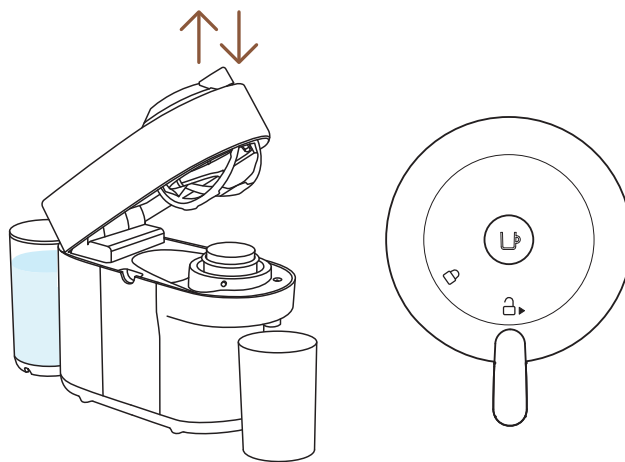

- 1 เมื่อเสียบปลั๊กเครื่องแล้ว ให้เปิดแล้วปิดส่วนหัวของเครื่องก่อน บิดก้านล๊อคไปที่ตำแหน่งปลดล๊อค

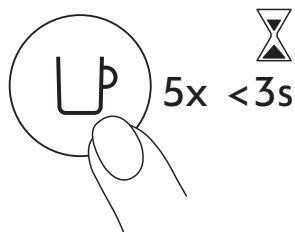

- 2 กดปุ่มท่ากาแฟ 5 ครั้งภายใน 3 วินาที ขณะนี้เครื่องได้รับการตั้งโปรแกรมด้วยการคืนค่าสู่การตั้งค่าจากโรงงาน

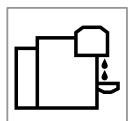
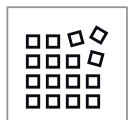

สถานะไฟกระพริบ

คุณต้องการเรียนรู้เพิ่มเติมเกี่ยวกับการกะพริบของ Vertuo Pop หรือไม
โปรดศึกษาคลิปวิดีโอได้ดังนี้:

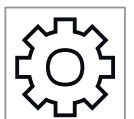
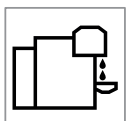

การแก้ไขปัญหาเบื้องต้น

ไม่มีไฟที่ปุ่มทำกาแฟ

- เครื่องปิดอัตโนมัติ; กดปุ่มทำกาแฟหรือหมุนก้านล๊อคไปยังตำแหน่ง “ปลดล๊อค” เครื่อง
- ตรวจสอบแหล่งจ่ายไฟ, ปลั๊ก, แรงดันไฟฟ้าและฟิวส์

ไม่มีกาแฟ/น้ำ

- ตรวจสอบว่ามีน้ำในถังน้ำหรือไม่
- ตรวจสอบว่าใส่แคปซูลใหม่เข้าไปในตำแหน่งที่ถูกต้อง ล๊อคก้านล๊อคอย่างถูกต้องหรือไม่ และกดปุ่มทำกาแฟเพื่อเริ่มต้น
- ขจัดตะกอนหากจำเป็น
- ยก/เปิดส่วนหัวของเครื่องเพื่อนำแคปซูลที่ใช้แล้วออก จากนั้นทำความสะอาดตามขั้นตอนการทำล้างทำความสะอาด

กาแฟไม่ร้อน/ไม่ร้อนพอ

- อุ่นแก้วกาแฟด้วยน้ำดื่มร้อน
- ขจัดตะกอนหากจำเป็น

กาแฟรั่วหรือไหลผิดปกติ

- ตรวจสอบว่าถังน้ำอยู่ในตำแหน่งที่ถูกต้องหรือไม่
- ขจัดตะกอนหากจำเป็น

เครื่องเปลี่ยนเป็น “โหมดปิด”

- เพื่อประหยัดพลังงาน เครื่องจะปิดหลังจากไม่ได้ใช้งานเป็นเวลา 2 นาที
- เครื่องสามารถ “ปิด” โดยผู้ใช้งานได้ตลอดเวลา (เมื่อไม่ได้ใช้งาน) โดยกดปุ่มทำกาแฟค้างไว้ 3 วินาที

พบกากกาแฟในแก้ว

- ทำตามขั้นตอนการทำความสะอาดสองครั้งหรือจนกว่าน้ำสุดท้ายที่ออกมาจะใส (ไม่พบกากกาแฟ)
- โปรดศึกษาหัวข้อ “การทำความสะอาด”

เครื่องไม่เริ่มทำงานแต่ไฟปุ่มทำกาแฟสว่างคงที่ หากไฟกะพริบให้ดูหัวข้อถัดไป

- ตรวจสอบว่าก้านล๊อคอยู่ในตำแหน่งล๊อคที่ถูกต้องหรือไม่
- หากคุณต้องการสก๊ตกาแฟหรือเอสเพรสโซให้ตรวจสอบว่าใส่แคปซูลใหม่ในตำแหน่งที่ถูกต้อง ก้านล๊อคล๊อคที่ตำแหน่งที่ถูกต้อง และกดปุ่มทำกาแฟเพื่อเริ่มสก๊ต
- หากคุณกำลังทำความสะอาด ขจัดตะกอนหรือการถ่ายน้ำออกจากระบบ ให้ตรวจสอบว่าไม่มีแคปซูลใดถูกใส่เข้าไป จากนั้นล๊อคเครื่อง โดนม้วนก้านล๊อคไปยังตำแหน่งล๊อค และกดปุ่มทำกาแฟเพื่อเริ่มการทำงานอย่างใดอย่างหนึ่งเหล่านี้

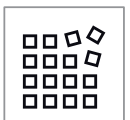

เครื่องไม่เริ่มทำงาน และไฟกะพริบสลับกัน กะพริบ 1 ครั้งและหยุดชั่วคราว 1 ครั้ง

ไฟกะพริบขณะเครื่องกำลังทำงาน

ไฟกะพริบและเครื่องไม่ทำงาน

ไฟจะกะพริบสลับกัน กะพริบ 2 ครั้ง และหยุดชั่วคราว 1 ครั้งอย่างต่อเนื่อง. เครื่องไม่ทำงาน

- เติมน้ำลงในถังน้ำและกดปุ่มทำกาแฟเพื่อเริ่มต้นกระบวนการ
- ตรวจสอบว่าหมუნก้านลอคไปยังตำแหน่งลอคอย่างถูกต้อง
- ถ้ากาแฟไหลตามปกติ แสดงว่าเครื่องทำงานปกติ
- หากมีเพียงน้ำเท่านั้นที่ไหล แสดงว่าเครื่องกำลังดำเนินการตามคำขอของผู้ใช้สำหรับการทำความสะอาด ขจัดคราบตะกรัน หรือการถ่ายน้ำออกจากระบบ โปรดศึกษาส่วนที่เกี่ยวข้องในคู่มือผู้ใช้นี้
- ตั้งค่าเครื่องให้เครื่องอยู่ในสถานะ “ปิด” โดยกดปุ่มทำกาแฟค้างไว้ 3 วินาทีแล้วกดปุ่มทำกาแฟอีกครั้งเพื่อเปิดเครื่อง รอประมาณ 20 นาทีเพื่อให้เครื่องเย็นลงหลังจากใช้งานเป็นเวลานาน
- จะใช้เวลาสักครู่ก่อนที่กาแฟจะไหลออกมา (เนื่องจากการอ่านบาร์โค้ดและการแช่กาแฟก่อนเริ่มสกัด)
- ตรวจสอบว่าใส่แคปซูลในตำแหน่งที่ถูกต้อง บิดก้านลอคไปยังตำแหน่งลอคอย่างถูกต้อง และกดปุ่มทำกาแฟเพื่อเริ่มการทำงาน
- เติมน้ำในถังน้ำและกดปุ่มทำกาแฟเพื่อเริ่ม
- ตั้งค่าเครื่องให้เครื่องอยู่ในสถานะ “ปิด” โดยกดปุ่มทำกาแฟค้างไว้ 3 วินาทีแล้วกดปุ่มทำกาแฟอีกครั้งเพื่อเปิดเครื่อง รอประมาณ 20 นาทีเพื่อให้เครื่องเย็นลงหลังจากใช้งานเป็นเวลานาน
- ระหว่างการเตรียมกาแฟแก้วใหญ่/เอสเพรสโซ:
 - 1) ปลดลอคก้านลอคและยก/เปิดส่วนหัวของเครื่องเพื่อตรวจสอบว่าใส่แคปซูลใหม่ที่ไม่มีเสียหายในตำแหน่งที่ถูกต้อง
 - 2) ตรวจสอบว่าก้านลอคอยู่ในตำแหน่ง “ลอค”
 - 3) ตรวจสอบว่าถังน้ำมีน้ำอยู่ในระดับเต็ม
- ระหว่างการขจัดคราบตะกรัน การถ่ายน้ำออกจากระบบ และการล้างทำความสะอาด
 - 1) ตรวจสอบว่าแคปซูลถูกกำจัดออกจากเครื่องชงกาแฟ
 - 2) ตรวจสอบว่าก้านลอคอยู่ในตำแหน่ง “ลอค”
- ระหว่างการปรับปริมาณกาแฟ
 - 1) ตรวจสอบว่าใส่แคปซูลดีแล้วหรือไม่
 - 2) โปรดศึกษาหัวข้อที่เกี่ยวข้อง **“ปรับระดับปริมาณกาแฟของคุณ”**

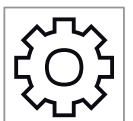
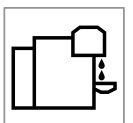

ไฟกระพริบสลับกัน 3 ครั้งแล้วสว่างคงที่

- หากปัญหายังคงอยู่:
 - 1) ปลดลอคก้านลอคและยก/เปิดส่วนหัวของเครื่องขึ้น
 - 2) เปลี่ยนแคปซูลใหม่ (หากจำเป็น)
 - 3) ถอดปลั๊กไฟออกจากเต้าเสียบรอ 10 วินาที จากนั้นเสียบปลั๊กเครื่องกลับเข้าที่เต้ารับ
 - 4) กด/ปิดส่วนหัวของเครื่องลงเพื่อเปิดเครื่อง และกดปุ่มทำกาแฟเพื่อเริ่มสกัดกาแฟ
 หากยังพบปัญหา โปรดติดต่อ **Nespresso**.
- จำเป็นต้องล้างตะกรัน: สามารถใช้เครื่องได้เพียงไม่กี่ครั้งหลังจากที่การแจ้งเตือนการขจัดตะกรันปรากฏขึ้น ก่อนที่จะจำเป็นต้องล้างคราบตะกรัน

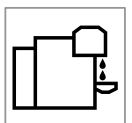

ข้อมูลจำเพาะทางเทคนิค

กำลังไฟ	~220–240 V, 50–60 Hz, 1300–1500 W US, CA: 120 V, 60 Hz, 1500 W MX: 127 V~, 60 Hz, 1380 W
ความถี่	2.402–2.480 GHz
กำลังในการส่งสัญญาณที่ส่งออก (EIRP)	Bluetooth 4 dBm Max. e.i.r.p. และ Wi-Fi <20 dMm max. e.i.r.p.
Standby	0.39 W/h
โหมดประหยัดพลังงาน	ปิดอัตโนมัติหลังจากไม่ได้ใช้งาน 2 นาที
ระยะเวลาทำความร้อน	30 วินาที (เปิดส่วนหัวของเครื่องและก้านลือคอยู่ตำแหน่งลือค)
ฐานรองแก้วสามารถเคลื่อนย้ายได้ สำหรับกาแฟขนาดใหญ่	ตำแหน่งเดียวที่ถอดออกได้
ความยาวสายเคเบิลจากตัวเครื่อง	75 ซม. / 30 นิ้ว
ขนาด (กว้างxยาวxสูง)	13.6 x 42.6 x 25 cm / 5.3 x 16.7 x 9.8 in
น้ำหนัก	3.5 kg / 7.72 lbs
ความจุถังน้ำ	600 ml / 20 fl oz
ความจุของภาชนะบรรจุแคปซูลที่ใช้แล้ว	8 เอสเพรสโซแคปซูล หรือ 5 มัคแคปซูล

รหัสเครื่อง

Nespresso	Breville	Delonghi
GCV2, GDV2	BNV120, BNV150	ENV90
Krups	Magimix	
XN9201, XN9204, XN9205, XN9211	M800	

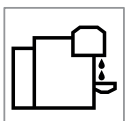
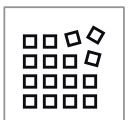

CLIQUE E ESCOLHA SUA LÍNGUA

BR



SEGURANÇA



VISÃO GERAL



CONECTIVIDADE



PRIMEIRAS ETAPAS



PREPARO DO CAFÉ



ADAPTE O TAMANHO DOS SEUS CAFÉS



LIMPEZA



DESCALCIFICAÇÃO



ESVAZIANDO O SISTEMA



RESTAURAR AS CONFIGURAÇÕES DE FÁBRICA



ÍNDICE DAS LUZES PISCANTES



SOLUÇÃO DE PROBLEMAS



ESPECIFICAÇÕES

SEGURANÇA

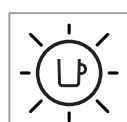
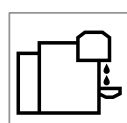
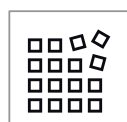
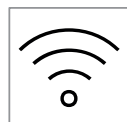

CUIDADO: Antes de utilizar sua máquina de café, consulte o folheto de instruções de segurança para evitar possíveis danos e prejuízos.

DESCARTE E PROTEÇÃO AMBIENTAL

Este aparelho está em conformidade com a Diretiva da UE 2012/19/EC. As embalagens e o aparelho contêm materiais recicláveis. Seu aparelho contém materiais valiosos que podem ser recuperados ou reciclados. A separação de materiais residuais em diferentes tipos facilita a reciclagem de matérias-primas valiosas. Deixe o aparelho em um ponto de coleta. Você pode obter mais informações sobre descarte com as autoridades locais responsáveis.



VISÃO GERAL

VISÃO GERAL DA MÁQUINA

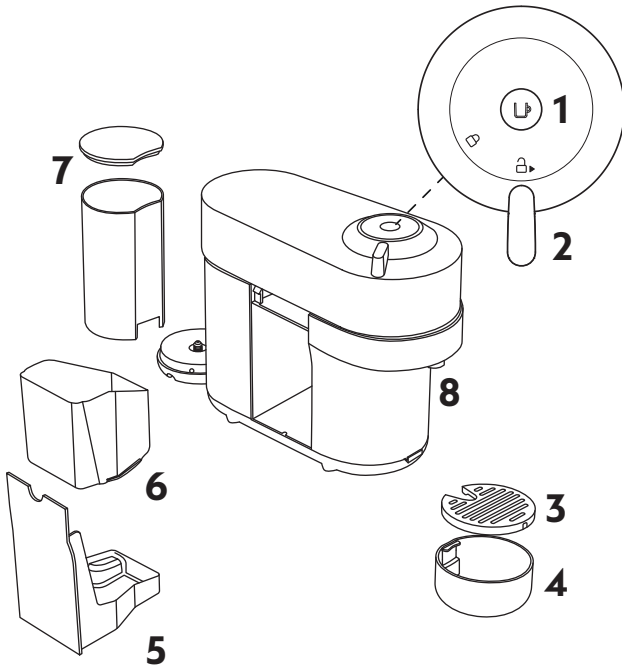

- 1 Botão liga/desliga e de café
- 2 Trava/destrava da alavanca
- 3 Grade de gotejamento
- 4 Suporte ajustável de copo
- 5 Bandeja de gotejamento
- 6 Coletor de cápsulas usadas
- 7 Reservatório de água e tampa
- 8 Saída de café

CONTEÚDO DA EMBALAGEM



- 1 Máquina de café
- 2 Caixa de cápsulas **Nespresso**
- 3 Material de boas-vindas da **Nespresso**
- 4 Instruções de segurança
- 5 Guia de início rápido
- 6 Garantia

i Desembalando: pode haver poeira na superfície da máquina, devido aos materiais de embalagem reciclados utilizados. Isso não representa perigo, apenas limpe com um tecido macio.

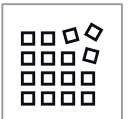

ABRIR/ FECHAR

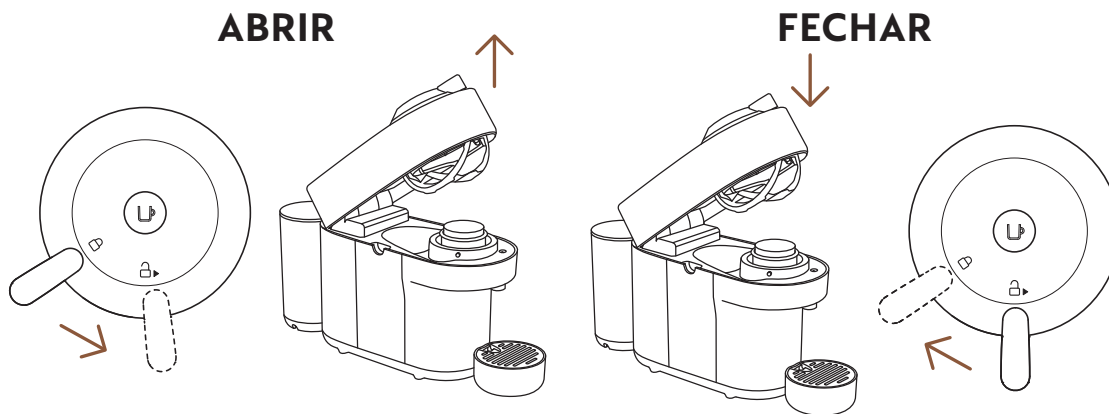

ATENÇÃO: Para o uso correto da máquina, não abra enquanto o café estiver sendo extraído, aguarde até que a máquina pare e o botão esteja aceso com uma luz branca. Se você desejar parar a extração antes da máquina finalizar, pressione o botão e aguarde até que ele pare de piscar.

O SISTEMA VERTUO

CÁPSULAS COMPATÍVEIS



ACESSÓRIOS COMPATÍVEIS



Acessórios
compatíveis



Acessórios
incompatíveis



Descubra nossa coleção de acessórios em www.nespresso.com

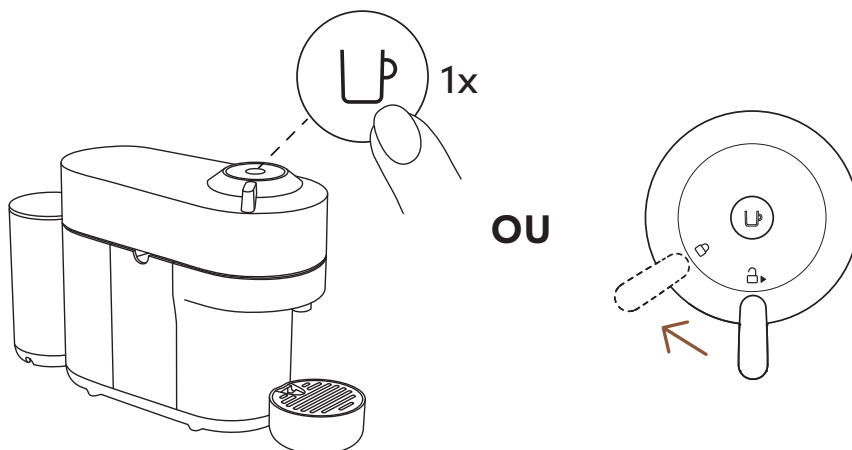

LIGA/DESLIGA

**LIGA**

Assim que a máquina estiver conectada na tomada, ligue-a pressionando o botão de café uma vez ou fechando a alavanca na posição travada.

- i** A luz piscará por aproximadamente 30 segundos enquanto a máquina estiver esquentando. Quando a luz estiver estática, a máquina estará pronta para uso.

**DESLIGA**

Para economizar energia, a máquina será desligada após 2 minutos de inatividade.

- i** A máquina pode ser desligada de forma manual (quando não estiver em uso) pressionando o botão por 3 segundos.

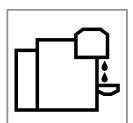

CONECTIVIDADE

POR QUE VOCÊ DEVE PAREAR SUA VERTUO POP



BENEFÍCIOS DE CONECTAR SUA MÁQUINA VERTUO POP

- **Café inteligente:** Esteja sempre atualizado sobre as últimas inovações de café **Nespresso**
- **Conselho de especialista:** Tenha suporte e tutoriais simples em seu smartphone para acompanhar sua jornada em cafés.
- **Cuidados com a máquina:** Receba notificações instantâneas de como e quando fazer manutenções em sua máquina com guia passo a passo fácil sobre como descalcificar, enxaguar, realizar limpeza, etc.

COMO CONECTAR SUA MÁQUINA VERTUO POP?



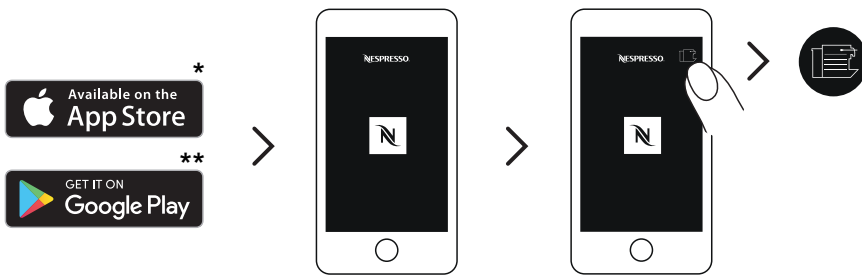

- 1** Faça o download ou atualize o seu Aplicativo **Nespresso**. Abra o App e clique no ícone de máquina no canto superior direito da tela.

OBSERVAÇÃO: para uma melhor experiência, nós recomendamos que conecte sua máquina a um roteador Wi-Fi ao invés de usar a rede do celular.

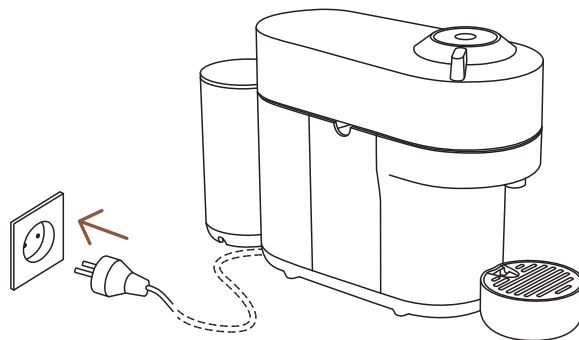

- 2** Conecte o cabo na tomada.



- 3** Siga as instruções no Aplicativo **Nespresso**.

CUIDADO: Antes de tudo, leia as instruções de segurança para evitar riscos fatais de choque elétrico e incêndio.

- * App Store® é uma marca comercial da Apple Inc., registrada nos EUA e em outros países.
- ** Google Play e o logotipo do Google Play são marcas registradas da Google LLC.



DESATIVANDO BLUETOOTH E WIFI DA MÁQUINA

A máquina vem com o módulo de conectividade padrão, que te dá acesso a funcionalidades adicionais para elevar sua experiência em cafés. Para desativar o módulo de conectividade, siga os passos abaixo:

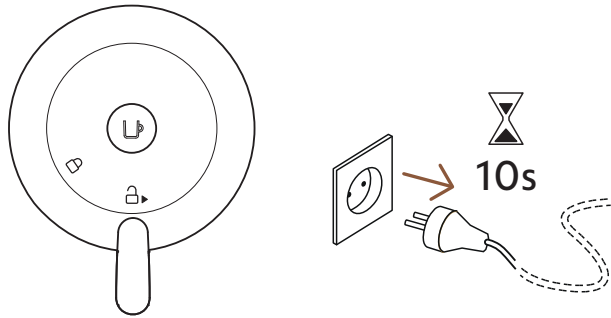

- 1** Com a máquina fechada e a alavanca destravada, desligue a máquina da tomada por pelo menos 10 segundos.

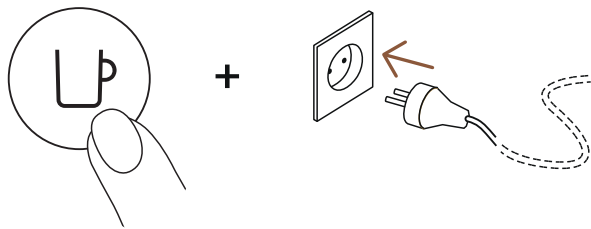

- 2** Pressione e segure o botão enquanto conecta. O botão ficará laranja para confirmar que a conectividade foi desativada.
- i** Siga os mesmos passos para ativar novamente a conectividade. O botão ficará branco para confirmar que o módulo foi reativado.

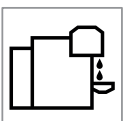
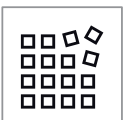

PRIMEIRAS ETAPAS

PRIMEIRO USO

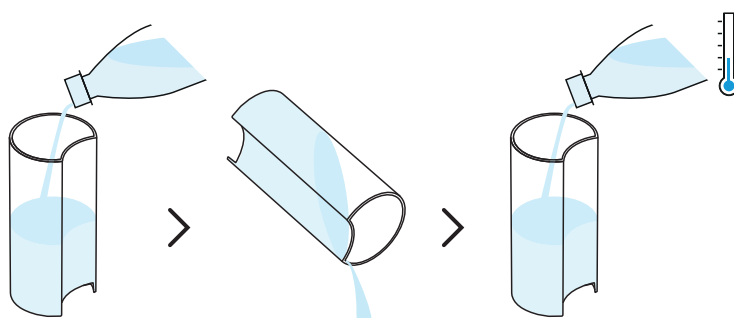

- 1** Enxague e limpe o tanque antes de enchê-lo com água potável.

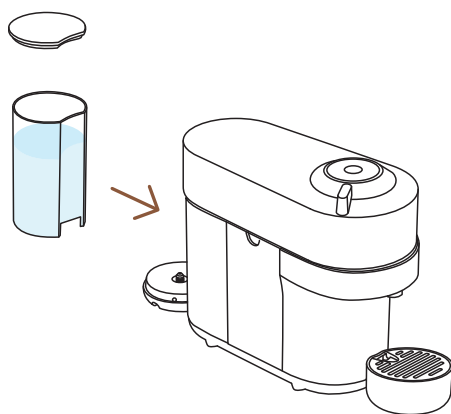

- 2** Feche o tanque com a tampa e certifique-se que está bem encaixado.

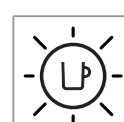
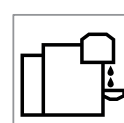
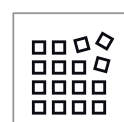
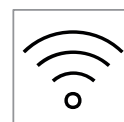

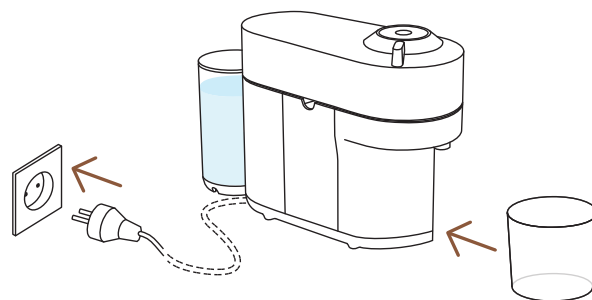

- 3** Conecte o cabo de alimentação, remova o suporte para copos e coloque um recipiente vazio (de pelo menos 1 L/ 34 fl oz) na saída do café.

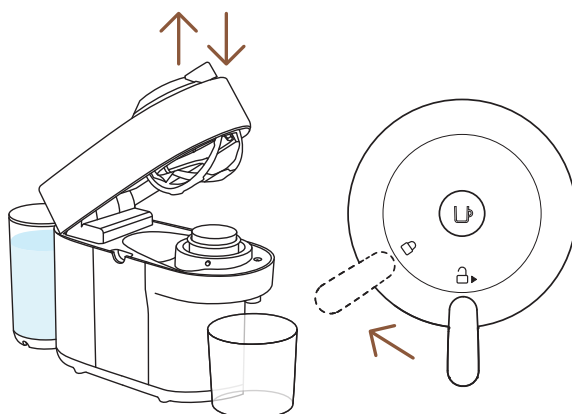

- 4** Abra e feche a máquina. Certifique-se que a alavanca está na posição correta e travada.

- i** A luz piscará enquanto a máquina estiver esquentando. Levará aproximadamente 30 segundos. Quando a luz ficar estável, a máquina está pronta. Certifique-se de que nenhuma cápsula esteja inserida.

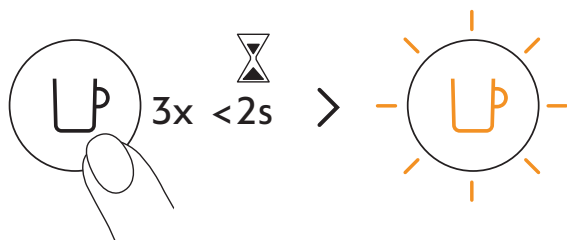

- 5** Pressione o botão 3 vezes em 2 segundos para iniciar o enxágue. Deixe o procedimento de enxágue ser concluído automaticamente. Quando a luz fica branca constante, o ciclo está completo.

- i** Deve demorar menos de 2 minutos antes do início do processo de enxágue e a água começa a fluir. Este procedimento pode levar mais de 7 minutos.

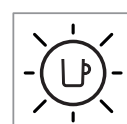
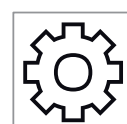
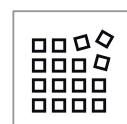
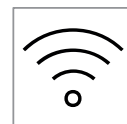

PREPARO DO CAFÉ

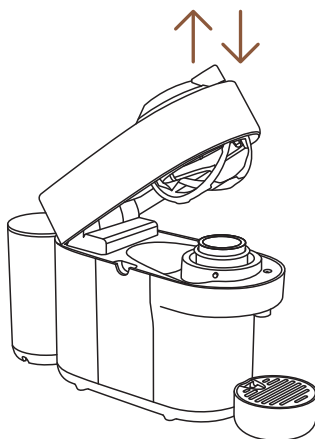

1 Abra e feche a máquina.

i A luz do botão de café piscará enquanto a máquina estiver aquecendo. Quando a luz ficar estável, a máquina estará pronta para uso.

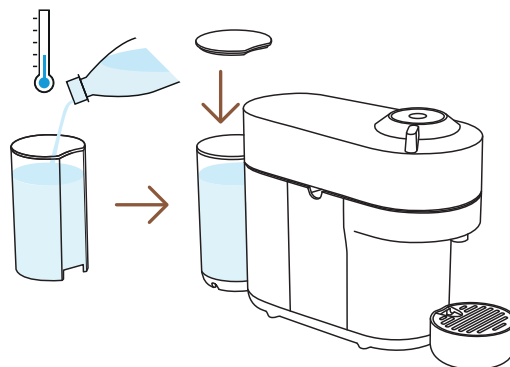

2 Encha o tanque com água potável e coloque-o de volta na posição correta.

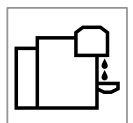
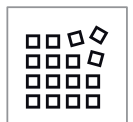

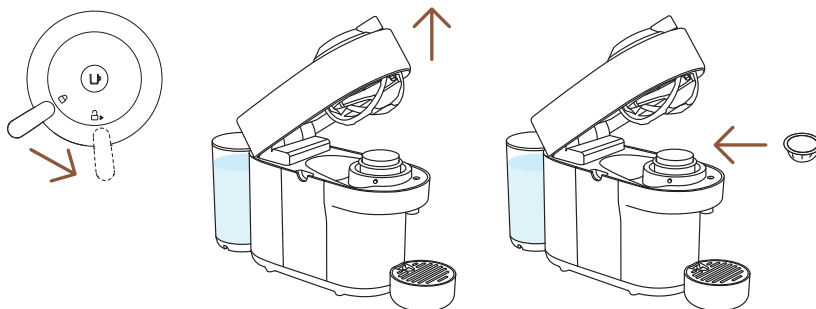

- 3** Destrave e abra completamente a parte superior da máquina e insira uma Cápsula Vertuo com formato da cúpula voltado para baixo.

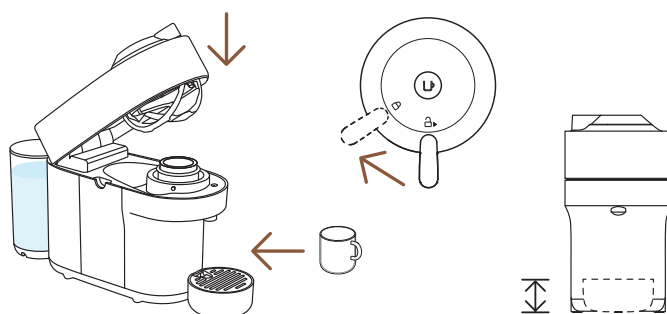

- 4** Feche a parte superior da máquina e trave girando a alavanca para a esquerda até a posição travada e coloque uma xícara. O suporte para copos pode ser ajustado para acomodar o tamanho do seu copo.

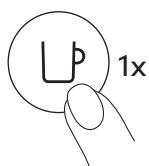

- 5** Comece a extração pressionando o botão uma vez.

CUIDADO: para uso correto da máquina, não abra a parte superior da máquina enquanto o café está sendo preparado, espere até que a máquina pare e o botão de café esteja estável e branco. Se você quiser parar a preparação antes, pressione o botão uma vez e espere até que o café pare de sair e o botão fique com a luz branca e constante.

- i** Devido à leitura do código de barras, pré-umedecimento do café e tempo de infusão, levará um tempo antes que o café comece a ser extraído. A máquina irá reconhecer automaticamente a cápsula inserida e selecionar o tamanho ideal para a preparação.

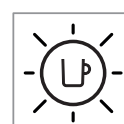
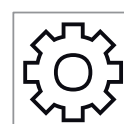
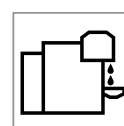
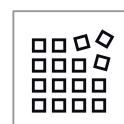
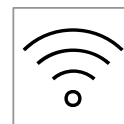

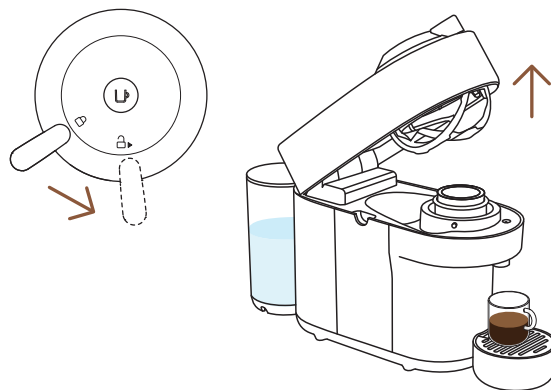

- 6** Quando o café parar de ser preparado, abra a parte superior da máquina girando a alavanca para a direita em direção à posição destravada para sua cápsula ser descartada automaticamente.



- 7** Não se esqueça de reciclar suas cápsulas **Nespresso**.*

* SE É **NESPRESSO**, É RECICLÁVEL. Para mais informações sobre como reciclar suas cápsulas **Nespresso**, acesse www.nespresso.com/reciclagem

DESCUBRA NOSSAS CRIAÇÕES DE CAFÉ



Com esta máquina, a **Nespresso** oferece uma função específica para concentrar suas extrações de café e criar suas próprias receitas.

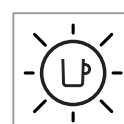
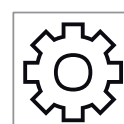
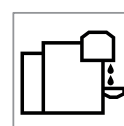
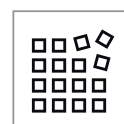
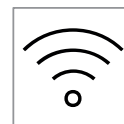

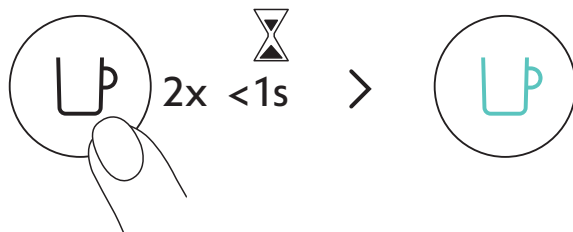

Com a máquina ligada, clique duas vezes no botão café. Piscará em turquesa e sua bebida de café ficará concentrada, otimizando o sabor do café em receitas com complementos (leite, creme, com gelo...).

40 ml	80 ml	150 ml	230 ml	355 ml	535 ml
✓	✓	✓	✓	✗	✗
25 ml	40 ml	40 ml	80 ml		

Para aproveitar ao máximo os benefícios, recomendamos preparar nossa família de cafés Coffee+, usando apenas os tamanhos oficiais de xícaras. Para obter os melhores resultados na xícara, não recomendamos preparar nosso XL (Alto Ambrato, Alto Onice), Cold Brew Style e Jarra Pour Over Style com este modo.

NOTA: Uma atualização da sua máquina através do aplicativo **Nespresso** é necessária para ativar este modo.



Descubra como atualizar sua máquina com nosso Aeroccino conectado www.nespresso.com

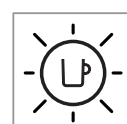
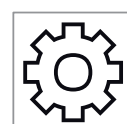
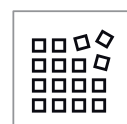
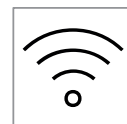

ADAPTE O TAMANHO DOS SEUS CAFÉS

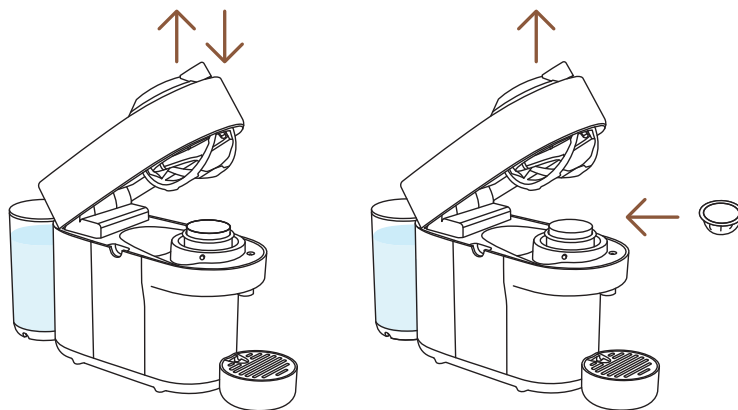

- 1** Abra a máquina e insira a cápsula que deseja configurar a dose.

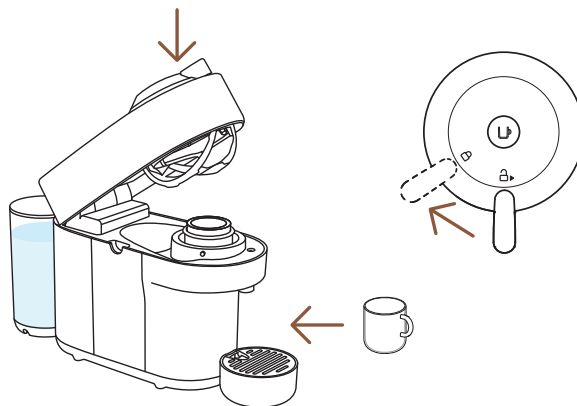

- 2** Feche a parte superior da máquina, gire a alavanca para a esquerda em direção à trava e posicione um copo.

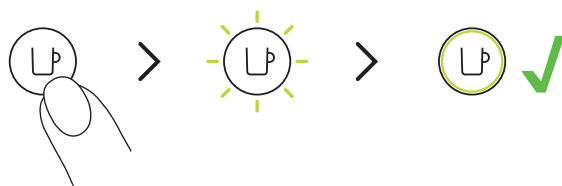

- 3** Pressione e mantenha pressionado o botão até que a quantidade desejada seja atingida. O novo volume de água agora está programado para o tipo de cápsula usada durante a extração.

- i** A programação é específica para cada tipo de cápsula. Os tamanhos dos copos podem ser programados de 20 ml até 535 ml.

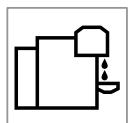

CUIDADO: para uso correto da máquina, não abra a parte superior enquanto o café está sendo preparado, espere até que a máquina pare e o botão de café esteja estável e branco. Se você quiser parar a preparação antes, pressione o botão uma vez e espere até que o café pare de sair e o botão volte para branco estável.

NOTA: Uma vez que um volume específico é programado pelo usuário, cada vez que esse tipo de cápsula é inserido na máquina, o preparo irá parar no tamanho do copo programado pelo usuário. Se você quiser voltar para o parâmetro padrão, consulte o parágrafo **“Redefinir as configurações de fábrica”**.

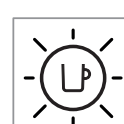
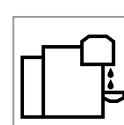
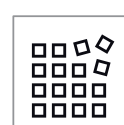
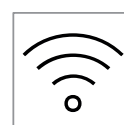

LIMPEZA

Limpe sua máquina mensalmente, quando começar a ter resíduo de café dentro da parte superior da máquina ou após um longo período de não utilização.

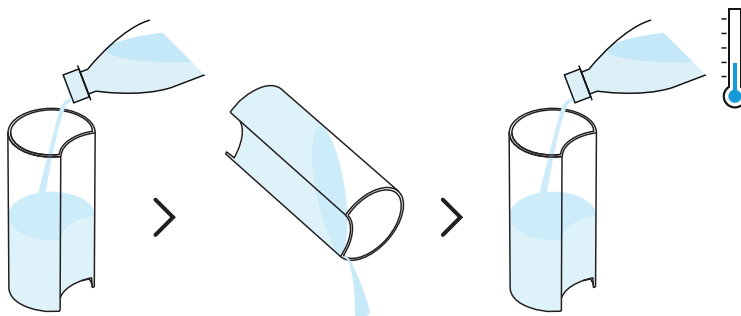

- 1** Enxágue e limpe o reservatório de água e a tampa antes de enchê-lo com água potável.

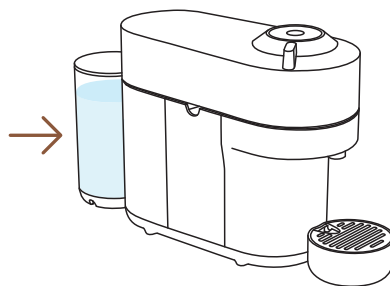

- 2** Coloque o recipiente de água de volta na posição correta.

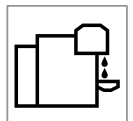
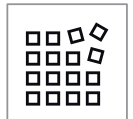

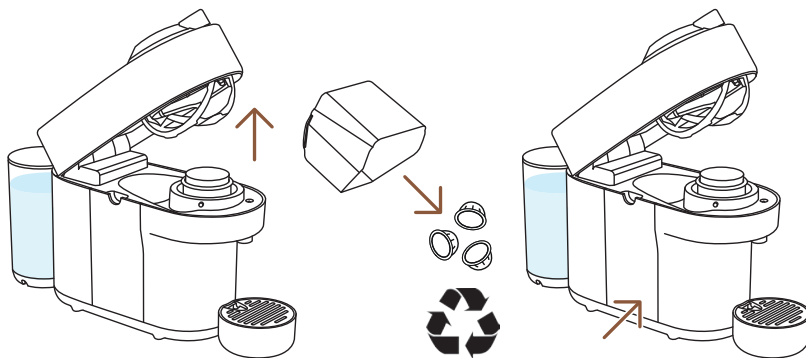

- 3** Desbloqueie e abra a máquina e deixe a cápsula usada ser ejetada. Esvazie e enxágue o recipiente da cápsula e a bandeja de gotejamento e coloque-os de volta no lugar. Não se esqueça de reciclar suas cápsulas **Nespresso**.*

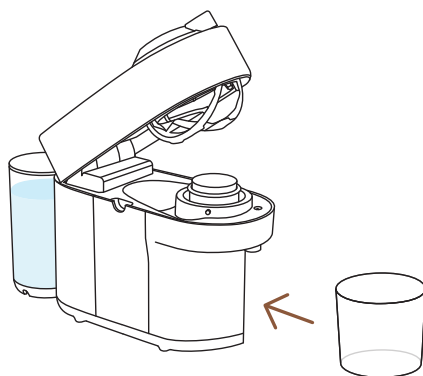

- 4** Retire o suporte para copos e coloque um recipiente vazio (de pelo menos 1 L/34 fl oz) sob a saída de café.

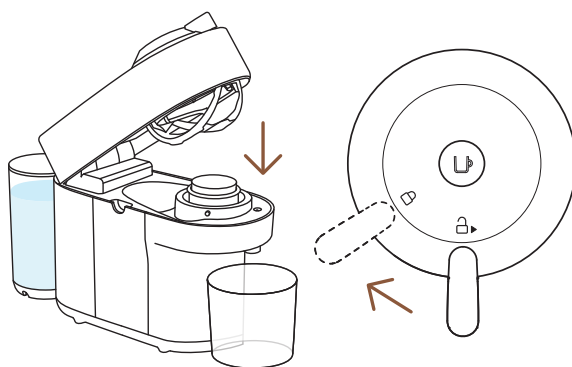

- 5** Feche a parte superior da máquina e gire a alavanca para a esquerda para travar. Certifique-se de que nenhuma cápsula esteja presente na máquina antes de iniciar o procedimento de limpeza.

* SE É **NESPRESSO**, É RECICLÁVEL. Para mais informações sobre como reciclar suas cápsulas **Nespresso**, acesse www.nespresso.com/reciclagem

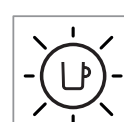
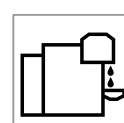
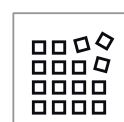
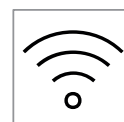

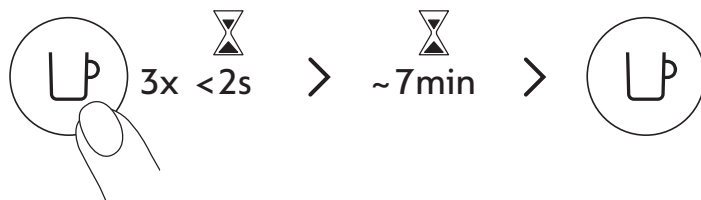

- 6** Pressione o botão 3 vezes em 2 segundos para iniciar o enxágue. Deixe que o procedimento de limpeza seja concluído automaticamente.

- i** Deve demorar menos de 2 minutos antes do início do processo de limpeza e a água começar a fluir. Esta operação pode levar até 7 minutos e irá parar automaticamente quando o ciclo for concluído. O procedimento pode ser encerrado a qualquer momento, pressionando o botão.

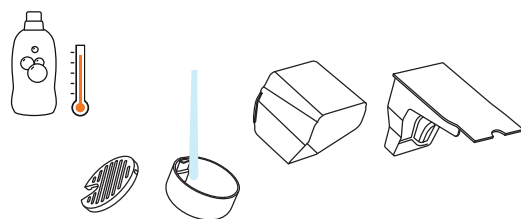

- 7** Lave o recipiente das cápsulas, o suporte do copo ea bandeja de gotejamento com água quente e detergente neutro.

CUIDADO: Não use nenhum agente de limpeza ou solvente forte ou abrasivo limpador. Não coloque a máquina na máquina de lavar louça. Nunca mergulhe o aparelho ou parte dele em água.

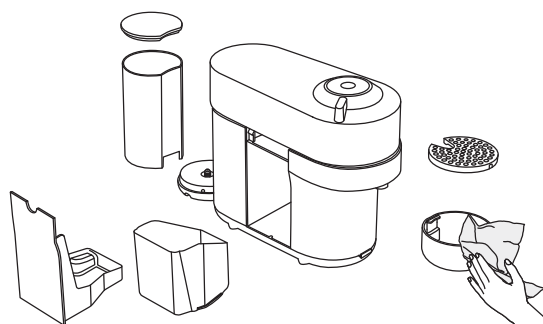

- 8** Seque com uma toalha limpa

CUIDADO: Limpe regularmente a saída de café com um pano limpo e húmido. Utilize sempre panos macios para limpar a máquina.

NOTA: É possível que a água se acumule no interior da unidade de extração. Por favor, seque as partes visíveis com um pano limpo e seco.

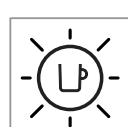
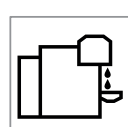
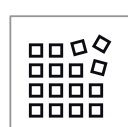
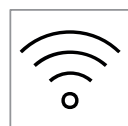

DESCALCIFICAÇÃO

A descalcificação da sua máquina garantirá que ela funcione corretamente durante toda a sua vida útil e tornará a sua experiência de café tão incomparável como foi o primeiro dia. Sua máquina indicará quando a descalcificação for necessária, piscando em laranja 3 vezes antes branco constante.



i O procedimento de descalcificação demora cerca de 20 minutos e **não pode ser interrompido**.

NOTA: Leia atentamente as instruções da descalcificação antes de começar.

Você precisará de:

- Um kit de descalcificação disponível em www.nespresso.com
- Um recipiente vazio (de 1 L/34 fl oz)

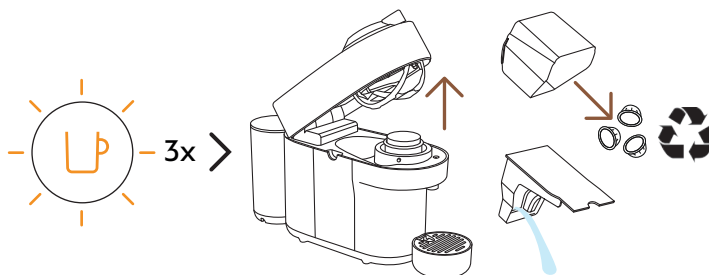

1 Com o botão laranja piscando 3 vezes: Desbloqueie e abra a parte superior da máquina e deixe a cápsula usada ser ejetada. Esvazie o recipiente das cápsulas e a bandeja coletora e coloque-os de volta na posição correta. Não se esqueça de reciclar suas cápsulas **Nespresso**.*

* SE É **NESPRESSO**, É RECICLÁVEL. Para mais informações sobre como reciclar suas cápsulas **Nespresso**, acesse www.nespresso.com/reciclagem

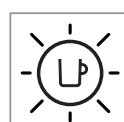
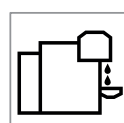
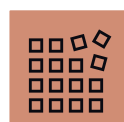
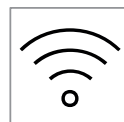

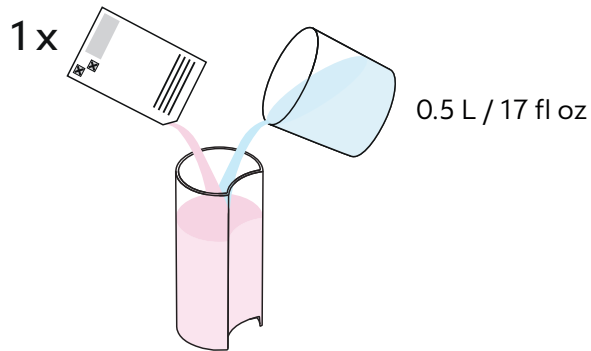

- 2** Encha o tanque de água com 0,5 L/17 fl oz de água e adicione 1 unidade de líquido descalcificante **Nespresso**.

CUIDADO: Fique atento, a solução descalcificante pode ser prejudicial. Evite contato com olhos, pele e superfícies.

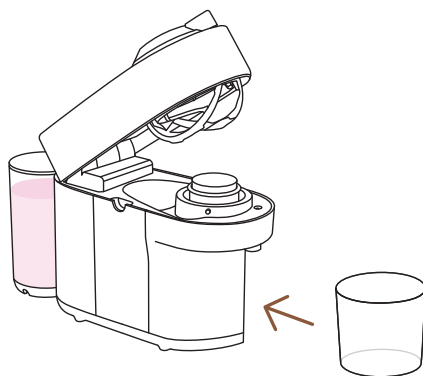

- 3** Retire o suporte para copos e coloque um recipiente vazio (de pelo menos 1 L/fl 34 onças) sob a saída de café.

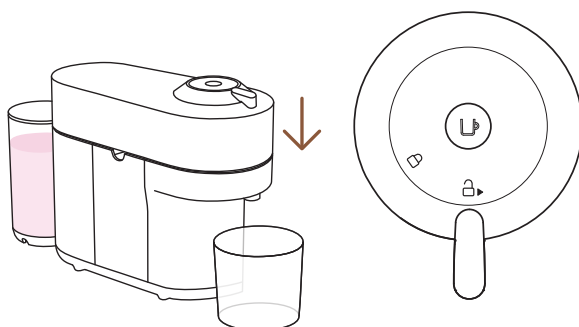

- 4** Com a máquina ligada, feche a parte superior da máquina e deixe a alavanca na posição destravada.

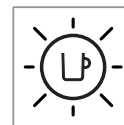
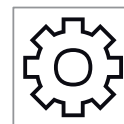
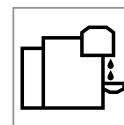
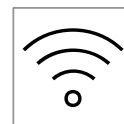

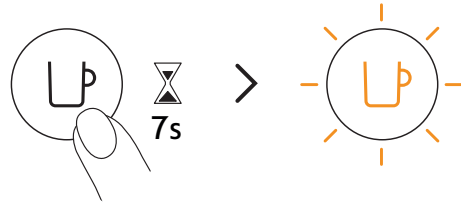

- 5** Segure o botão por pelo menos 7 segundos ou até ver o a luz apagar. O botão começará a piscar em laranja rapidamente.

CUIDADO: Agora você tem 45 segundos para entrar no modo de descalcificação, caso contrário, a máquina retornará ao modo de preparação.

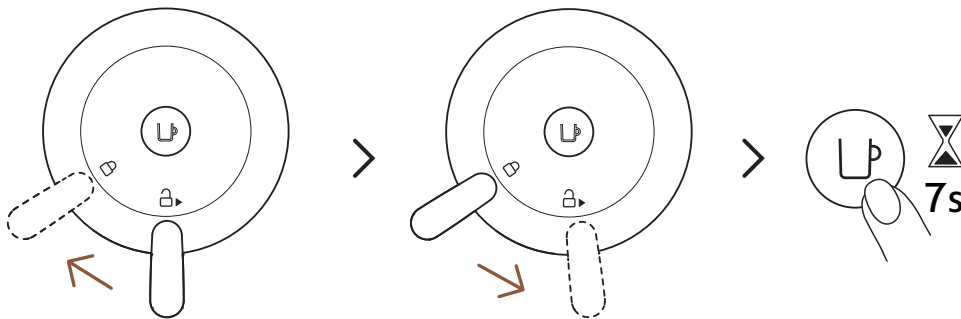

- 6** Trave o cabeçote da máquina girando a alavanca para a esquerda até que símbolo de bloqueio e, em seguida, destrave a alavanca girando para a direita para a posição de desbloqueio. Pressione e segure o botão novamente por aproximadamente 7 segundos ou até que a luz se apague. O botão começará a piscar em laranja rapidamente.

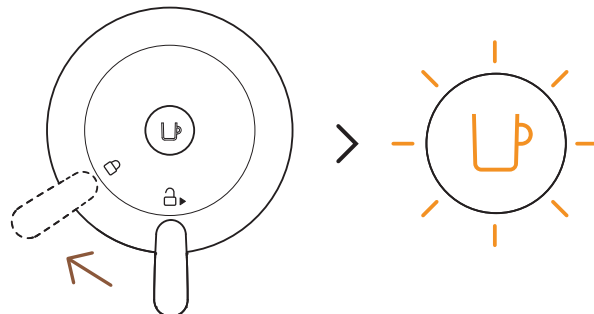

- 7** Para entrar no modo de descalcificação, bloqueie a máquina girando a alavanca para a esquerda em direção à posição travada. A luz ainda deve estar piscando em laranja rapidamente. Esta é uma indicação de que você tem entrado no modo de descalcificação.

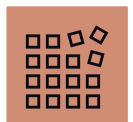

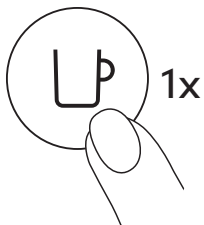

- 8** Pressione o botão de café uma vez para iniciar o processo de descalcificação. A luz piscará continuamente em laranja durante todo o processo.

- i** A máquina irá parar automaticamente quando o procedimento for concluído.

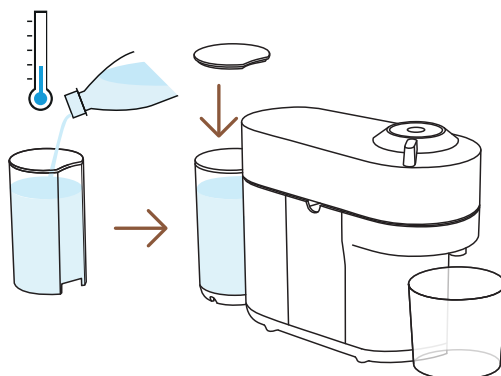

- 9** Ao final do processo de descalcificação, é hora de enxaguar o máquina. Enxágue bem o tanque de água, encha-o novamente com água potável e coloque-o de volta no lugar. Esvazie o recipiente e encaixe-o novamente.

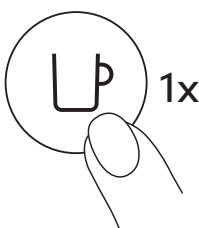

- 10** Pressione o botão para enxaguar a máquina. Quando o botão parar de piscar rapidamente e ficar estável, o indicador de processo de descalcificação está concluído.

- i** A máquina irá parar automaticamente quando o procedimento for concluído.

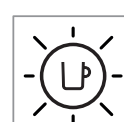
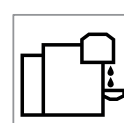
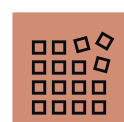
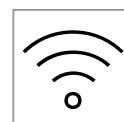

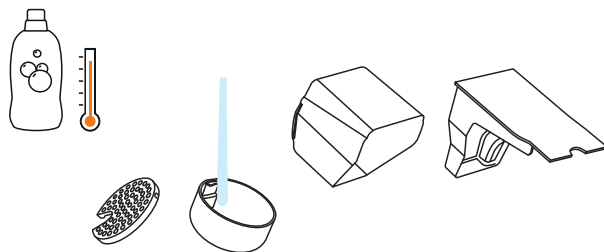

- 11** Lave o recipiente das cápsulas, o suporte do copo e o gotejador bandeja com água quente e detergente neutro sem aroma adicionado.

CUIDADO: Não use nenhum agente de limpeza ou solvente forte ou abrasivo limpador. Não coloque a máquina na máquina de lavar louça. Nunca mergulhe aparelho ou parte dele em água.

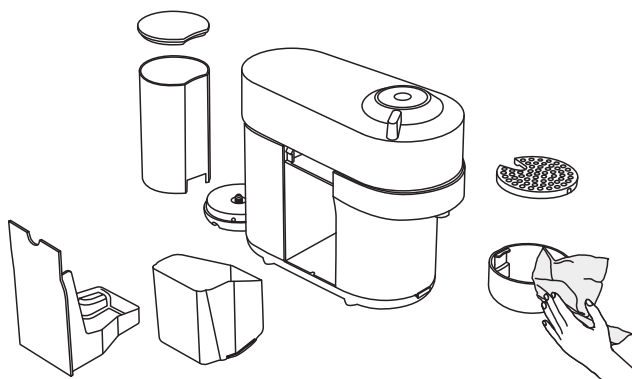

- 12** Seque a máquina com uma toalha limpa e seca. Após realizar o processo, aguarde 10 minutos para usa-la novamente.

NOTA: A água pode acumular-se dentro da parte superior da máquina durante a limpeza. Se isso acontecer, seque as partes visíveis com um pano limpo e seco.

NOTA: a máquina só pode entrar no modo de descalcificação após 30 ou mais cafés preparados.

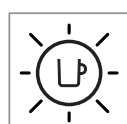
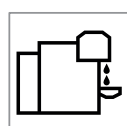
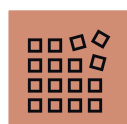
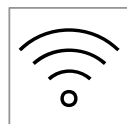

ESVAZIANDO O SISTEMA

Esvaziar o sistema é um processo que pode ser feito antes de um período de não utilização, para proteção contra congelamento ou antes de enviar o máquina para reparo.

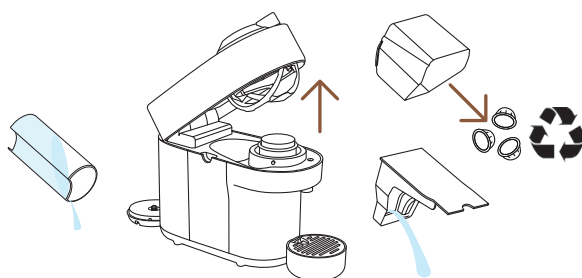

- 1** Esvazie o tanque de água, abra a parte superior da máquina e deixe que cápsula usada seja ejetada. Esvazie o recipiente da cápsula e a bandeja coletora. Não se esqueça de reciclar suas cápsulas **Nespresso**.*

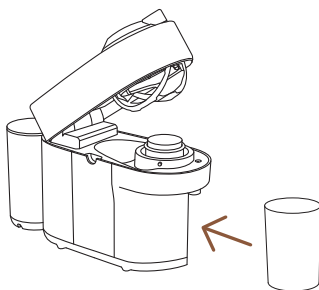

- 2** Coloque-os de volta na máquina, retire o suporte de copo e coloque um recipiente vazio (0,5 L / 17 fl oz) sob a saída do café.

* SE É **NESPRESSO**, É RECICLÁVEL. Para mais informações sobre como reciclar suas cápsulas **Nespresso**, acesse www.nespresso.com/reciclagem

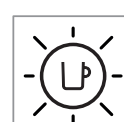
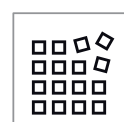
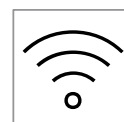

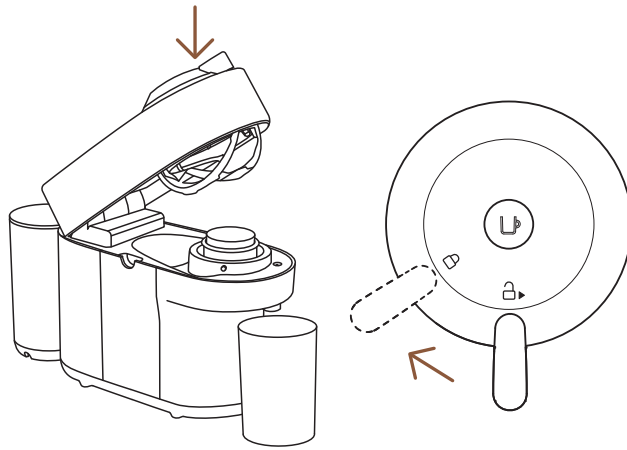

- 3** Com a máquina conectada, abra e feche a parte superior da máquina e gire a alavanca para a posição travada.

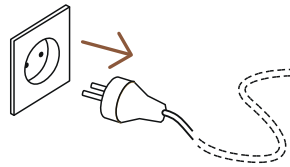

- 4** Desconecte a máquina

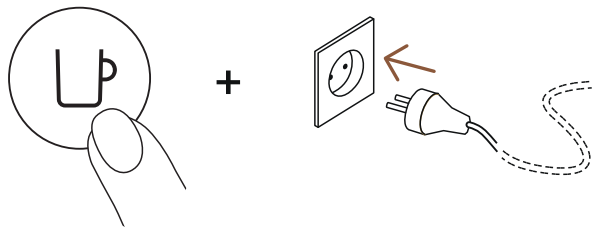

- 5** Pressione e segure o botão enquanto conecta



- 6** Solte o botão. Ele piscará em laranja e processo de esvaziamento será iniciado.

- i** A máquina levará aproximadamente 30 segundos para concluir o processo de esvaziamento. A máquina desliga automaticamente quando estiver vazio.

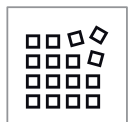

REDEFINIÇÃO DAS CONFIGURAÇÕES DE FÁBRICA

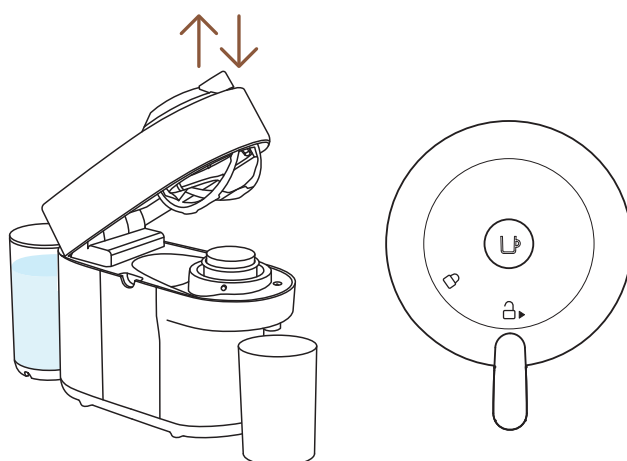

- 1 Com a máquina conectada, abra e feche a parte superior da máquina e gire a alavanca para a posição **travada**.

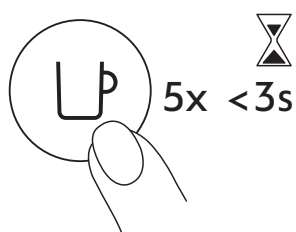

- 2 Pressione o botão cinco vezes dentro de três segundos. A máquina está programada com as configurações de fábrica.

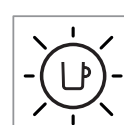
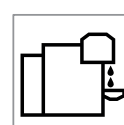
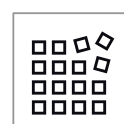
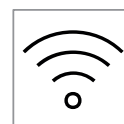

ÍNDICE DAS LUZES PISCANTES

Quer entender melhor sobre o painel de luzes de Vertuo Pop?
Assista o vídeo abaixo.

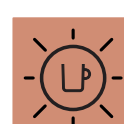
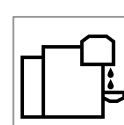
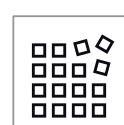
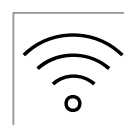

SOLUÇÃO DE PROBLEMAS

Botão apagado:

- A máquina desligou automaticamente; aperte o botão ou destrave a máquina
- Verifique a tomada, o conector, a voltagem e o fusível.

Sem café, sem água.

- Verifique se o reservatório de água está cheio
- Verifique se há uma cápsula nova inserida na posição correta e se a alavanca está devidamente travada e aperte o botão para iniciar.
- Se necessário, faça a descalcificação.
- Abra a tampa da máquina para que a cápsula seja ejetada. Em seguida, faça a limpeza segundo as instruções da seção correspondente.

O café não está suficientemente quente.

- Preequeça a xícara com água potável quente da torneira.
- Se necessário, faça a descalcificação.

Vazamento ou fluxo de café incomum.

- Verifique se o reservatório de água está posicionado corretamente.
- Se necessário, faça a descalcificação.

A máquina é desligada.

- Para economizar energia, a máquina será desligada após 2 minutos de inatividade.
- A máquina pode ser desligada de forma manual (quando não estiver em uso) pressionando o botão por 3 segundos.

Há pó de café na xícara.

- Realize o procedimento de limpeza duas vezes.
- Consulte o parágrafo sobre “Limpeza”

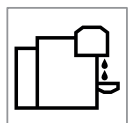

A máquina não começa a funcionar e a luz está acesa. Se a luz estiver piscando, consulte os itens a seguir.

A máquina não começa a funcionar e a luz pisca alternadamente: uma piscada e uma pausa.

A luz pisca com a máquina em operação.

A máquina não começa a funcionar e a luz pisca alternadamente: uma piscada e uma pausa.

- Verifique se a alavanca está devidamente travada.
- Se quiser preparar um Café ou um Espresso, verifique se há uma cápsula nova inserida na posição correta e se a alavanca está devidamente travada e aperte o botão para iniciar.
- Se estiver fazendo limpeza, descalcificando ou esvaziando o sistema, verifique se não há uma cápsula inserida e, em seguida, trave a máquina e aperte o botão para iniciar uma dessas operações.
- Encha o reservatório de água e aperte o botão para começar
- Verifique se a alavanca está devidamente travada.
- Se o café estiver fluindo normalmente, isso indica que a máquina está funcionando da forma correta
- Se houver fluxo apenas de água, a máquina está executando uma solicitação do usuário de limpeza, descalcificação ou esvaziamento do sistema. Consulte o capítulo correspondente.
- Coloque a máquina no modo DESLIGADO apertando o botão por 3 segundos e, em seguida, apertando-o novamente para ligar a máquina. Agora, aguarde aproximadamente 20 minutos até que a máquina esfrie após o uso intensivo.
- Levará algum tempo até que o fluxo de café comece (devido à leitura do código de barras e à pré-umidificação do café).
- Verifique se há uma cápsula nova inserida na posição correta e se a alavanca está devidamente travada e aperte o botão para iniciar.
- Encha o reservatório de água e aperte o botão para começar
- Coloque a máquina no modo DESLIGADO apertando o botão por 3 segundos e, em seguida, apertando-o novamente para ligar a máquina. Agora, aguarde aproximadamente 20 minutos até que a máquina esfrie após o uso intensivo.

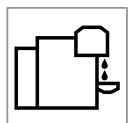

A luz pisca alternadamente duas vezes e faz uma pausa continuamente. A máquina não funciona.

- Durante a preparação regular de Café/ Espresso:
 - 1) Destrave a alavanca e abra a tampa da máquina para verificar se há uma cápsula nova e não danificada inserida na posição correta.
 - 2) Verifique se a alavanca está na posição travada.
 - 3) Verifique se o reservatório de água está cheio
- Durante a descalcificação, o esvaziamento e a limpeza:
 - 1) Verifique se a cápsula foi ejetada.
 - 2) Verifique se a alavanca está na posição travada.
- Durante a programação de volume:
 - 1) Cheque se a cápsula foi inserida corretamente.
 - 2) Consulte o capítulo correspondente.
- Se o problema persistir:
 - 1) Destrave a alavanca e abra a tampa da máquina
 - 2) Substitua a cápsula (se necessário).
 - 3) Desconecte o cabo de alimentação da tomada e reconecte a máquina à tomada após 10 segundos.
 - 4) Feche a tampa e pressione o botão para ligar e pressione novamente para iniciar a extração.

Se o problema persistir, ligue para a **Nespresso**.

Luz piscando alternadamente três vezes e, depois, ficando acesa.

- Descalcificação necessária: a máquina pode ser operada somente algumas vezes após esse alerta antes que a descalcificação se torne necessária

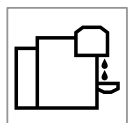

ESPECIFICAÇÕES

~220–240 V, 50–60 Hz, 1300–1500 W

US, CA: 120 V, 60 Hz, 1500 W

MX, BR: 127 V~, 60 Hz, 1380 W

Frequência	2.402–2.480 GHz
Frequência	Bluetooth 4 dBm Max. e.i.r.p. e Wi-Fi <20 dMm max. e.i.r.p
Modo de espera	0.39 W/h
Modo economia de energia	Desligamento automático: 2 minutos
Tempo de aquecimento	30 segundos (alavanca fechada e travada)
Suporte de xícara ajustável	Sim, 2 posições
Comprimento do cabo de energia	75 cm / 30 in
Dimensões (L x P x A)	13.6 x 42.6 x 25 cm / 5.3 x 16.7 x 9.8 in
Peso	3.5 kg / 7.72 lbs
Capacidade do tanque de água	600 ml / 20 fl oz
Capacidade do container de cápsula	8 cápsulas de espresso ou 5 cápsulas mug

CÓDIGO DA MÁQUINA

Nespresso	Breville	Delonghi
GCV2, GDV2	BNV120, BNV150	ENV90
Krups	Magimix	
XN9201, XN9204, XN9205, XN9211	M800	

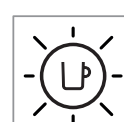
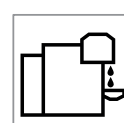
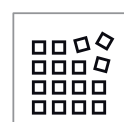
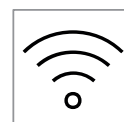

CLIC Y ELIJA SU LENGUAJE

ES



PRECAUCIONES DE SEGURIDAD



VISIÓN GENERAL



CONECTIVIDAD



PRIMER USO



PREPARACIÓN DE CAFÉ



AJUSTE EL VOLUMEN DE CAFÉ



LIMPIEZA



DESCALCIFICACIÓN



VACIADO DEL SISTEMA



RESETEAR LOS VALORES DE FÁBRICA



RESUMEN DEL PARPADEO



SOLUCIÓN DE PROBLEMAS



ESPECIFICACIONES

INDICACIONES DE SEGURIDAD

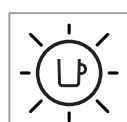
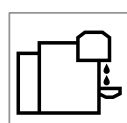
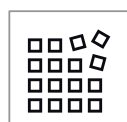
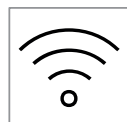

PRECAUCIÓN: Antes de operar su aparato, favor de referirse a las indicaciones de seguridad para evitar posibles daños o lesiones.

DESECHO Y PROTECCIÓN DEL AMBIENTE

Este aparato está en cumplimiento con lo estipulado por la EU 2012/19/EC. Los materiales de empaque y el aparato contienen piezas que pueden ser recicladas. Su aparato cuenta con piezas valiosas que pueden ser recuperadas o recicladas. La separación de los materiales en diferentes tipos facilita su reciclaje. Deje el aparato en un punto de recolección. Puede obtener información sobre el desecho con las autoridades locales.



VISIÓN GENERAL DE LA MÁQUINA

VISIÓN GENERAL DE LA MÁQUINA

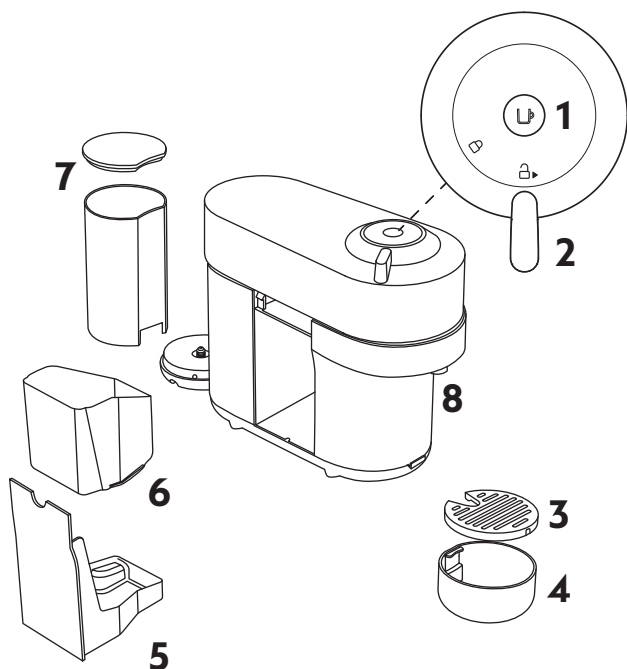

- 1 Botón ON/OFF y de café
- 2 Palanca de bloqueo/desbloqueo
- 3 Rejilla de goteo
- 4 Soporte para tazas ajustable
- 5 Bandeja de goteo
- 6 Contenedor de cápsulas usadas
- 7 Tanque de agua y tapa
- 8 Salida de café

CONTENIDO DEL EMPAQUE



- 1 Máquina de café
- 2 Set de cápsulas de degustación
- 3 Paquete Bienvenido a **Nespresso**
- 4 Instrucciones de seguridad
- 5 Guía de inicio rápido
- 6 Garantía

i Desembalaje: Un poco de polvo puede estar presente en la superficie de la máquina debido a los materiales reciclados que son utilizados para elaborar el embalaje. Esto no representa un riesgo, solo debe limpiar la máquina con un paño suave

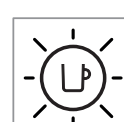
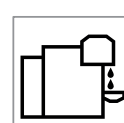
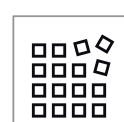
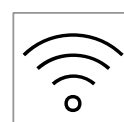

ABRIR/CERRAR

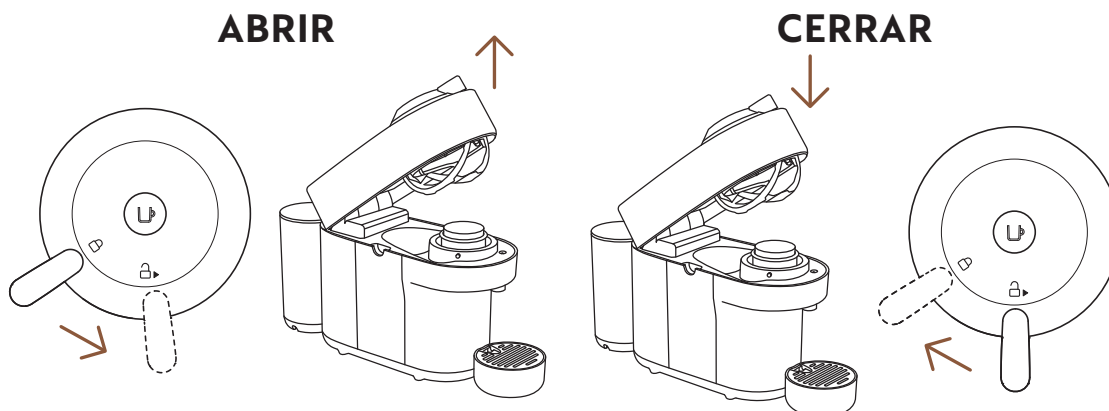

PRECAUCIÓN: Para el uso adecuado de la máquina, no abra el cabezal de la máquina durante la preparación del café, espere hasta que la luz del botón de café vuelva a estar fija en blanco. Si desea detener la preparación antes; presione una vez el botón de café y espere hasta que la máquina se detenga antes de abrir el cabezal de la máquina.

EL SISTEMA VERTUO

CÁPSULAS COMPATIBLES



S
Espresso
(40 ml)



M
Double Espresso
(80 ml)
Gran Lungo
(150 ml)



L
Mug
(230 ml)

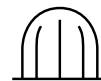

XL
Alto, Cold Brew Style
(355 ml)
Carafe
(535 ml)

ACCESORIOS COMPATIBLES



Accesorios compatibles



Espresso



Double Espresso



Gran Lungo



Mug (S)



Mug (M)



Vaso Reveal



Accesorios no compatibles



Mug (L)



Carafe

Descubra nuestra colección completa de accesorios en:

www.nespresso.com

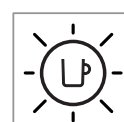
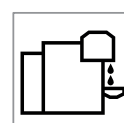
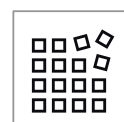
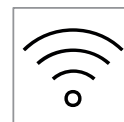

ENCENDIDO/APAGADO

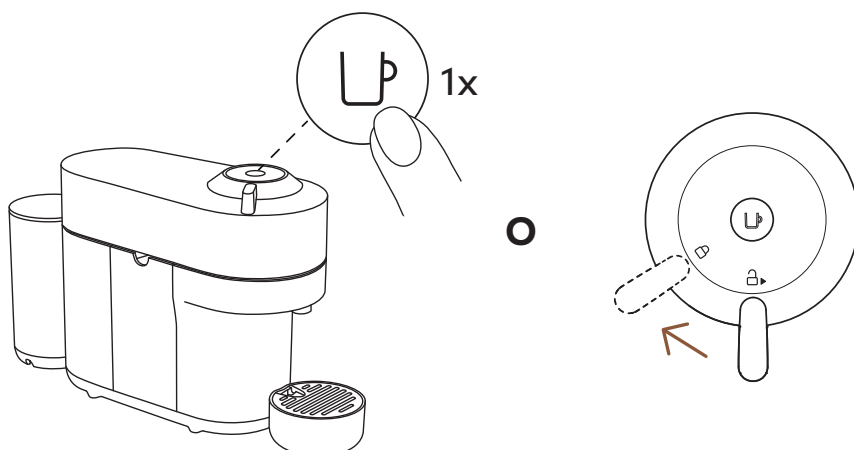
**ENCENDIDO**

Una vez que la máquina esté conectada, presione el botón una vez o mediante el cierre de la palanca en la posición de bloqueo (con el cabezal cerrado).

- i** La luz parpadeará por aproximadamente 30 segundos mientras la máquina está en calentamiento. Una vez que la luz esté fija, la máquina está lista para su uso.

**APAGADO**

Para ahorrar energía, la máquina se apagará después de 2 minutos sin uso.

- i** La máquina puede apagarse de manera manual en cualquier momento (cuando no esté en uso) al mantener presionado el botón por 3 segundos.

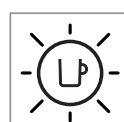
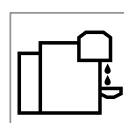
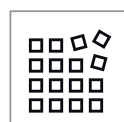
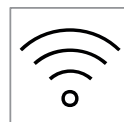

CONECTIVIDAD

¿POR QUÉ DEBERÍAS EMPAREJAR TU MÁQUINA VERTUO POP?



BENEFICIOS DE CONECTAR SU MÁQUINA VERTUO POP

- **Café inteligente:** Manténgase siempre un paso por delante para obtener lo último en nuestras innovaciones de café de **Nespresso** manteniendo su máquina al día.
- **Consejos del especialista:** Obtenga soporte y video tutoriales simples para acompañar su viaje de café a través de su smartphone.
- **Cuidado de la máquina:** Reciba una notificación instantánea sobre cómo y cuándo realizar el mantenimiento de su máquina con una guía de paso a paso sobre descalcificación, enjuague y limpieza.

¿CÓMO CONECTAR SU MÁQUINA VERTUO POP?

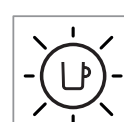
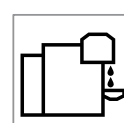
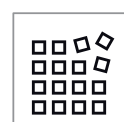
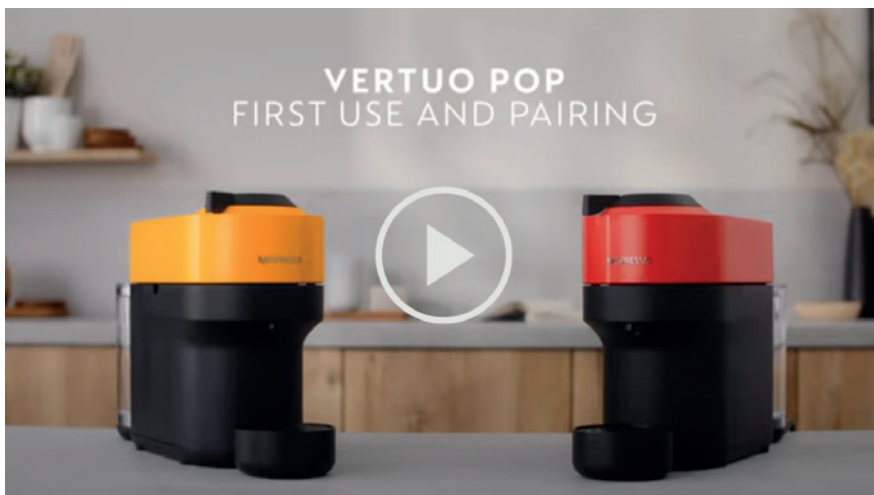

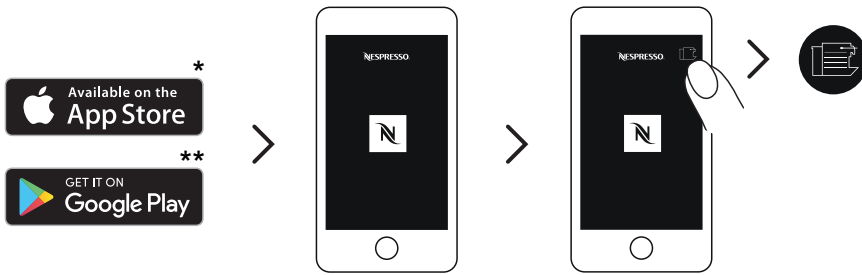

1 Descargue o actualice la App de **Nespresso**. Ejecute la App de **Nespresso** en su smartphone o su tableta. Presione el botón de máquina en la parte superior derecha de su pantalla.

NOTA: Para un óptimo funcionamiento y una experiencia perfecta, se recomienda conectar su máquina a un enrutador Wi-Fi en lugar de usar un punto de acceso de smartphone.

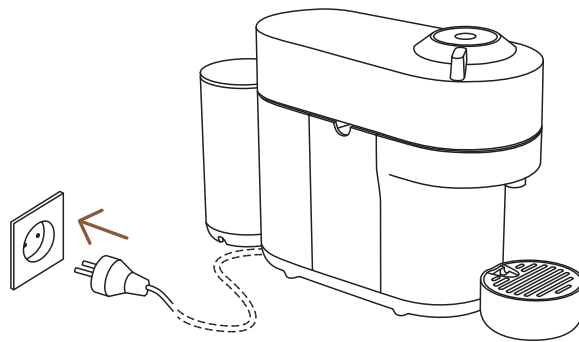

2 Conecte el cable de alimentación eléctrica.



3 Siga las instrucciones mediante la App de **Nespresso**.

PRECAUCIÓN: Primero lea las indicaciones de seguridad para evitar riesgos fatales o shock eléctrico e incendios. Asegure la conexión a tierra al conectar la máquina a la luz eléctrica.

* AppStore® es una marca registrada de Apple Inc., y registrada en EUA y otros países.
 ** Google Play y el logo de Google Play son marcas registradas de Google LLC.

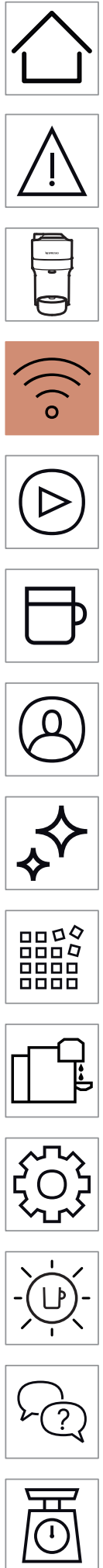

DESHABILITAR CONECTIVIDAD BLUETOOTH Y WI-FI

La máquina cuenta con un módulo de conectividad que está encendido por default. Brinda opciones adicionales, mejorando su experiencia de café. Para desconectar el módulo de conectividad, siga los siguientes pasos:

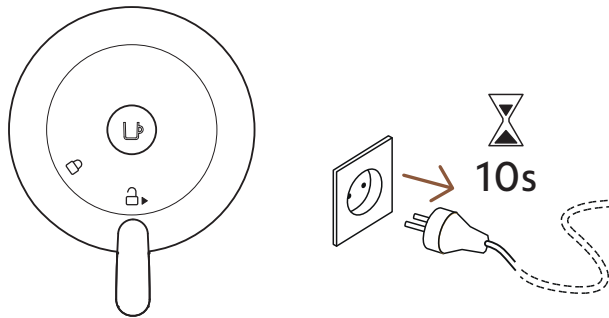

- 1 Con el cabezal de la máquina cerrado y la palanca en la **posición de desbloqueo**, desconecte la máquina por al menos 10 segundos.

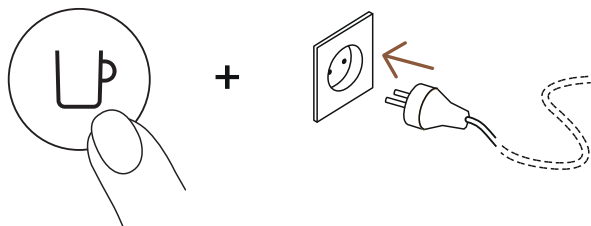

- 2 Mantenga presionado el botón mientras vuelve a conectar la máquina.
El botón parpadeará en color naranja para confirmar que el módulo de conectividad está desactivado.

- i** Siga los mismos pasos para encender de nuevo el módulo de conectividad. El botón parpadeará en color blanco para confirmar que se ha reactivado el módulo.

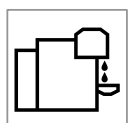

PRIMER USO

PRIMER ENJUAGUE

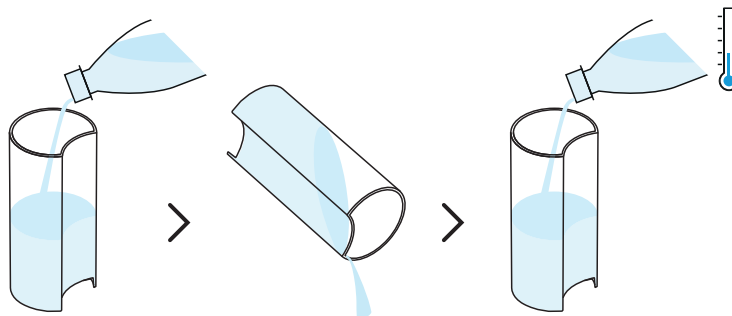

- 1** Primero enjuague y limpie el tanque de agua y la tapa antes de llenarlo con agua potable fresca.

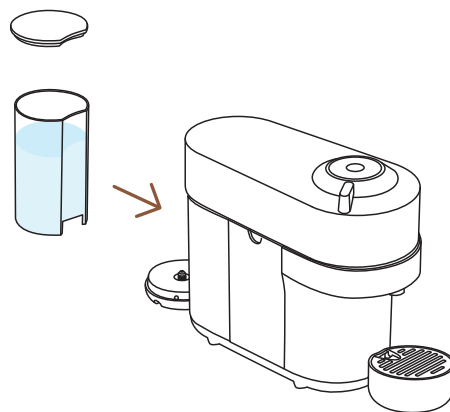

- 2** Cierre el tanque de agua con la tapa y coloque el tanque de agua en su lugar. Asegúrese de que esté bien sujeto.



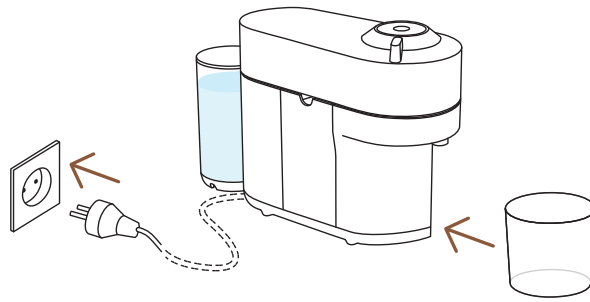

- 3** Conecte el cable de alimentación eléctrica, retire el soporte de tazas y coloque un contenedor vacío (de al menos 1 L) debajo de la salida de café.

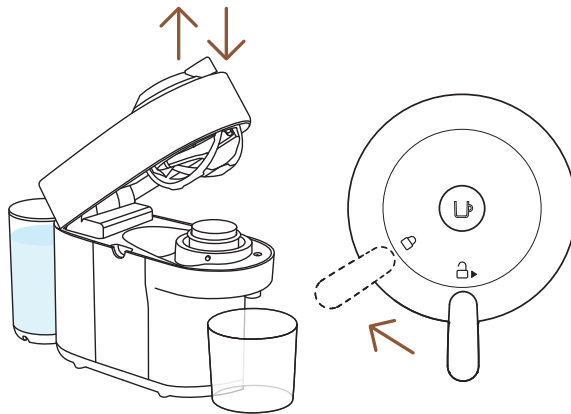

- 4** Abra y cierre la máquina. Asegure que la palanca está en la posición de bloqueo.

- i** La luz parpadeará mientras la máquina está en calentamiento. Tomará aproximadamente 30 segundos. Cuando la luz se mantenga fija la máquina estará lista. Asegúrese de que no exista ninguna cápsula insertada.

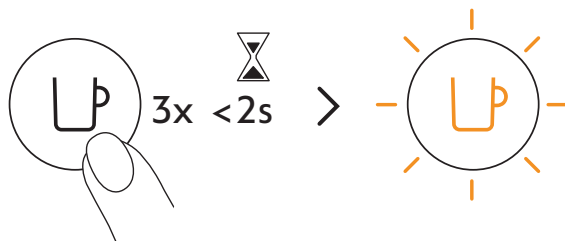

- 5** Presione el botón 3 veces en un periodo de 2 segundos. Con la luz naranja intermitente, deje que el proceso de enjuague se complete automáticamente. Cuando la luz se mantiene blanca, el ciclo está completo.

- i** Debe de tomar menos de 2 minutos antes de que comience el proceso de enjuague y el agua comience a fluir. Este proceso puede tomar hasta 7 minutos.

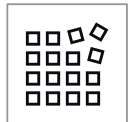

PREPARACIÓN DE CAFÉ

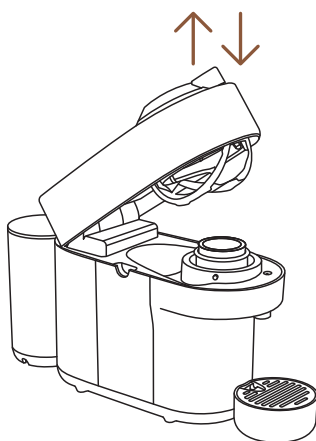

1 Abrir y cerrar la máquina.

i La luz del botón de café parpadeará mientras la máquina esté en calentamiento. Cuando la luz se vuelva fija, la máquina estará lista para usarse.

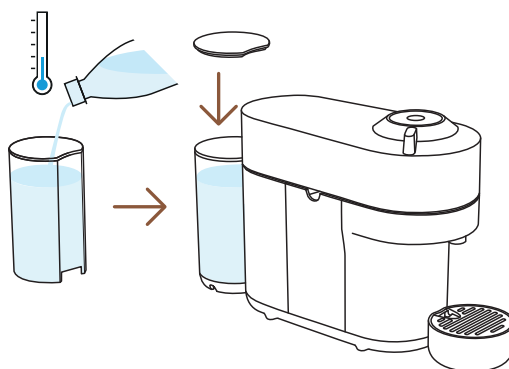

2 Llenar el tanque de agua con agua fresca potable y colocarlo de nuevo en su posición.

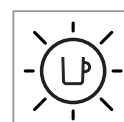
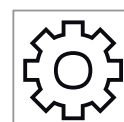
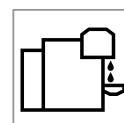
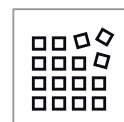
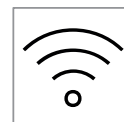

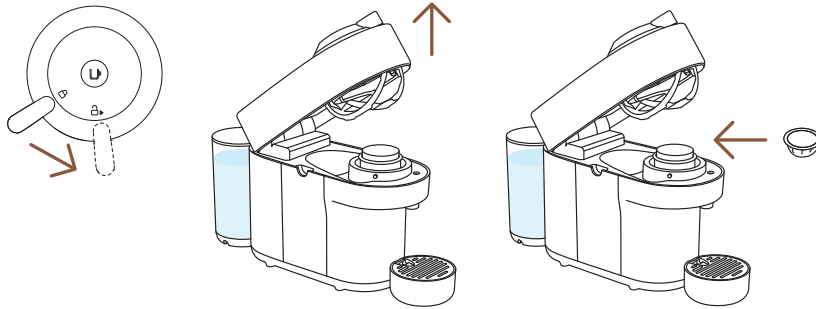

- 3** Desbloquee y abra el cabezal de la máquina por completo e inserte una cápsula Vertuo con la forma de domo hacia abajo.

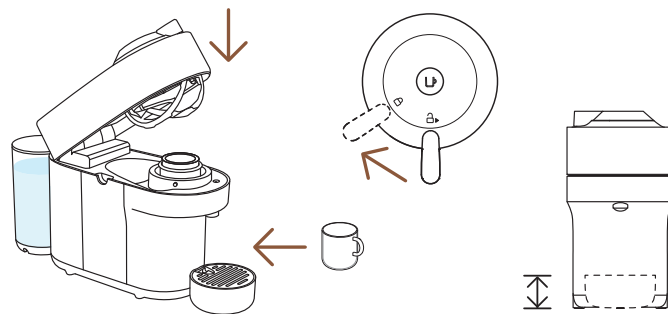

- 4** Cierre el cabezal de la máquina y bloquee el sistema girando la palanca hacia la izquierda hasta que posición de bloqueo y coloque una taza. El soporte de tazas puede ajustarse para acomodar su tamaño de taza.

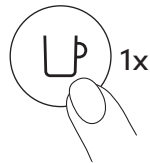

- 5** Inicie la extracción al presionar el botón una vez.

PRECAUCIÓN: Para el uso adecuado de la máquina, no abra el cabezal de la máquina durante la preparación del café, espere hasta que la luz del botón de café vuelva a estar fijo en blanco. Si desea detener la preparación antes; presione una vez el botón de café y espere hasta que la máquina se detenga antes de abrir el cabezal de la máquina.

- i** Debido a la lectura del código, el prehumedecimiento del café y el tiempo de la infusión, pasará un momento antes de que el café comience a fluir. La máquina reconocerá automáticamente la cápsula insertada y seleccionará los parámetros de preparación del café y la longitud de la taza definidos por los expertos en café de **Nespresso** para extraer las mejores mezclas de café.



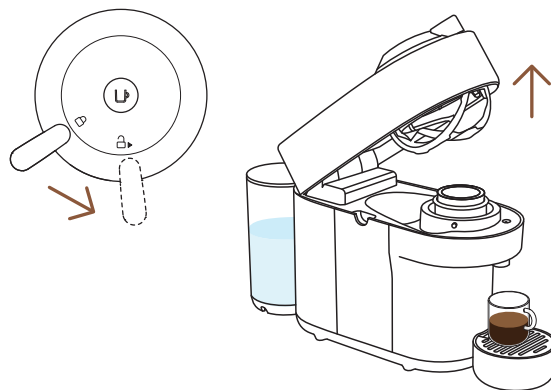

- 6** Cuando se finalice la preparación del café, abra el cabezal de la máquina girando la palanca hacia la derecha hacia la posición de desbloqueo para expulsar automáticamente la cápsula y disfrute su café.



- 7** No olvide reciclar sus cápsulas **Nespresso**.*

* ESTO ES **NESPRESSO**, ES RECICLABLE. Para más información de nuestro programa de reciclaje, visite www.nespresso.com

DESCUBRA NUESTRO MODO COFFEE CREATIONS.



Con esta máquina, **Nespresso** le ofrece una función específica para concentrar su extracción de café para crear sus propias recetas.

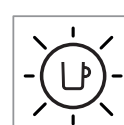
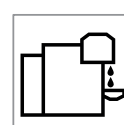
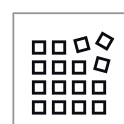
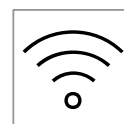

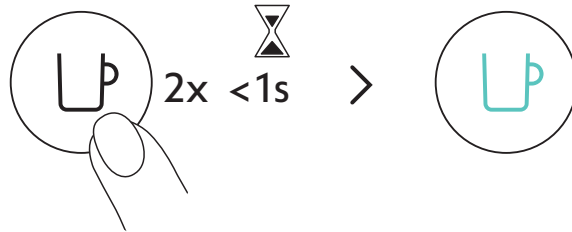

Con su máquina encendida, haga doble clic en el botón de café. Parpadeará color turquesa y la preparación de su café se concentrará, optimizando el sabor del café en recetas con complementos (leche, crema, sobre hielo...). Para una experiencia de café incomparable.

40 ml	80 ml	150 ml	230 ml	355 ml	535 ml
✓	✓	✓	✓	✗	✗
25 ml	40 ml	40 ml	80 ml		

Para disfrutar por completo los beneficios, recomendamos preparar nuestra gama de Coffee+ utilizando solo los tamaños oficiales de taza. Para obtener los mejores resultados en la taza, no recomendamos preparar nuestro XL (Alto Ambrato, Alto Onice), Cold Brew y Carafe Pour Over Style con este modo.

NOTA: Puede ser necesaria una actualización de su máquina a través de la aplicación de **Nespresso** para habilitar este modo.



Descubre cómo mejorar tu máquina con nuestros Aeroccinos en www.nespresso.com



AJUSTE EL VOLUMEN DE CAFÉ

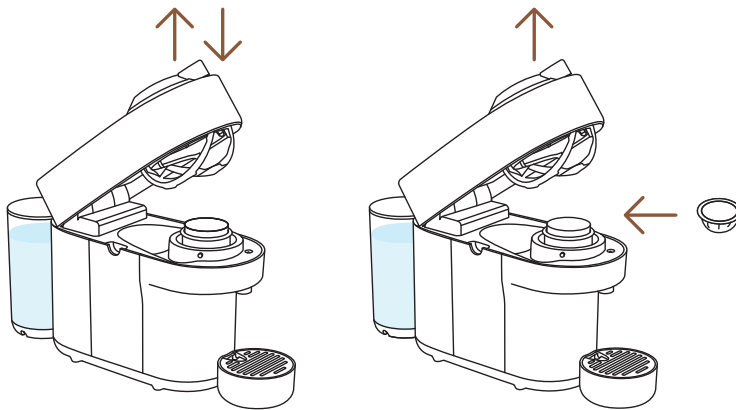

- 1** Abra y cierre la máquina. Con la máquina encendida, abra la máquina e inserte la cápsula que quiera programar.

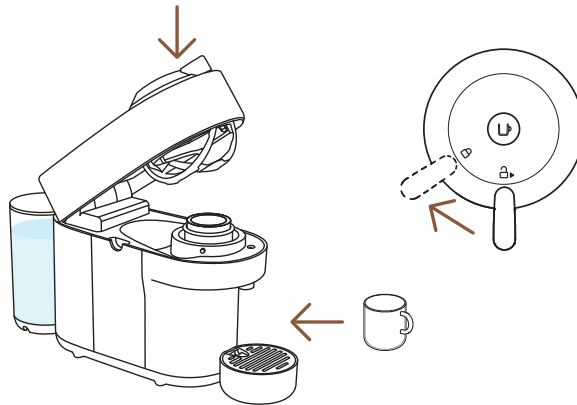

- 2** Cierre el cabezal de la máquina, gire la palanca a la izquierda hacia la posición de bloqueo y coloque una taza.

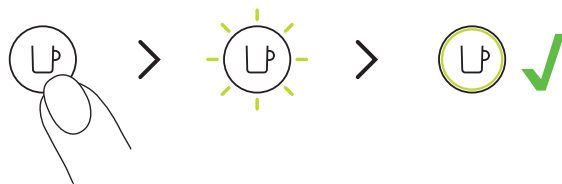

- 3** Mantenga presionado el botón hasta que alcance el volumen deseado. El volumen de agua ha sido programado para el tipo de cápsula usada durante el ajuste.

- i** La programación es específica para cada tipo de cápsula. Los tamaños de taza pueden ser programados desde 20 ml hasta 535 ml.

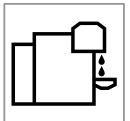

PRECAUCIÓN: Para el uso adecuado de la máquina, no abra el cabezal de la máquina durante la preparación del café, espere hasta que la luz del botón de café vuelva a estar fijo en blanco. Si desea detener la preparación antes; presione una vez el botón de café y espere hasta que la máquina se detenga antes de abrir el cabezal de la máquina.

NOTA: Una vez que se programa el volumen deseado por el usuario, cada vez que ese tipo de cápsula sea colocada en la máquina, la preparación parará en el volumen programado por el usuario. Si desea restaurar los valores de fábrica, ve la sección **“Restablecer los valores de fábrica”**.

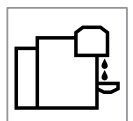
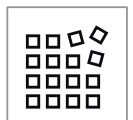

LIMPIEZA

Limpie su máquina mensualmente, cuando perciba residuos de café dentro del cabezal o después de un periodo largo sin uso.

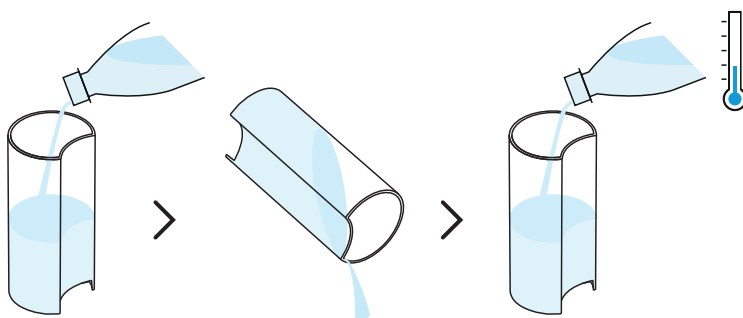

- 1** Enjuague y limpie el tanque de agua y la tapa antes de llenarlo con agua potable fresca.

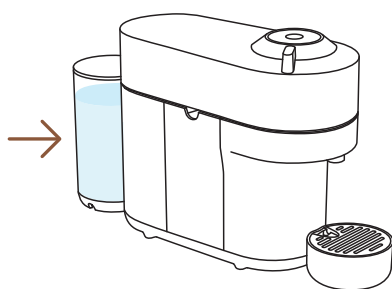

- 2** Coloque el tanque de agua de nuevo en la posición de la máquina.

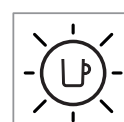
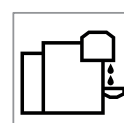
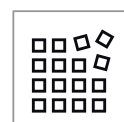
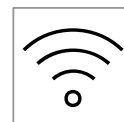

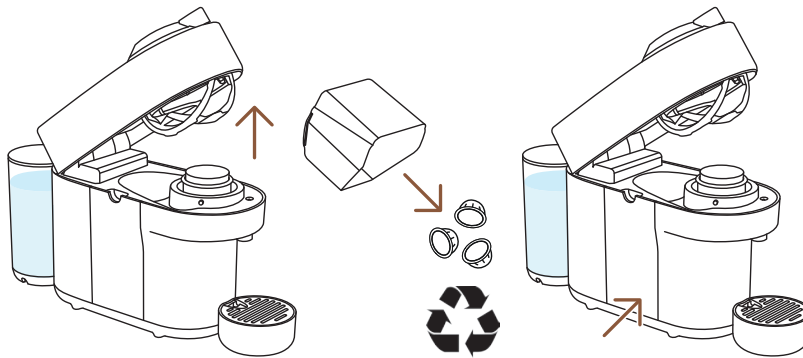

- 3** Con la máquina encendida, desbloquee y abra la máquina y deje que la cápsula usada sea expulsada. Vacíe y enjuague el contenedor de cápsulas y la bandeja de goteo y colóquelas de nuevo en su lugar. No olvide reciclar sus cápsulas **Nespresso**.*

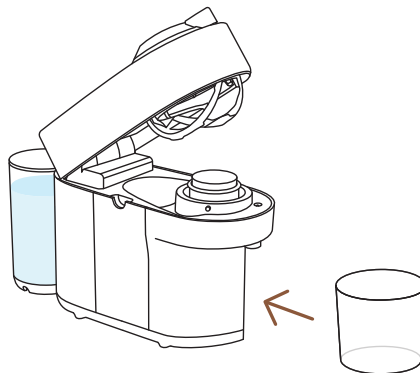

- 4** Retire el soporte de tazas y coloque un contenedor de al menos 1 L de capacidad debajo de la salida de café.

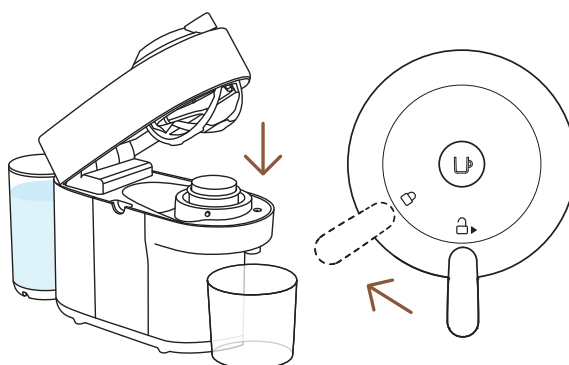

- 5** Cierre el cabezal de la máquina, gire la palanca a la izquierda hacia la posición de bloqueo y coloque una taza. Asegúrese de que no existan cápsulas en la máquina antes de iniciar el proceso de enjuague.

* ESTO ES **NESPRESSO**, ES RECICLABLE. Para más información de nuestro programa de reciclaje, visite www.nespresso.com

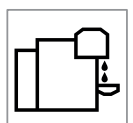

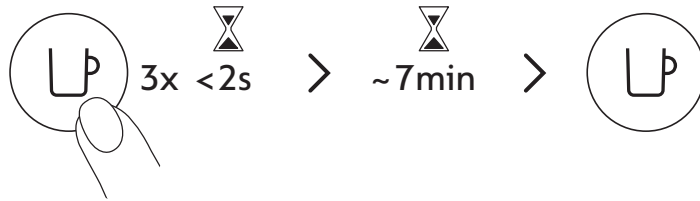

6 Presione el botón 3 veces en un periodo de 2 segundos. Con la luz parpadeando en color naranja, deje que el proceso de enjuague se complete automáticamente.

i Deberá de tomar menos de 2 minutos antes que comience el proceso de enjuague y el agua comience a fluir. Esta operación puede tardar hasta 7 minutos y se detendrá automáticamente cuando se complete el ciclo. El proceso se puede detener en cualquier momento al presionar el botón.

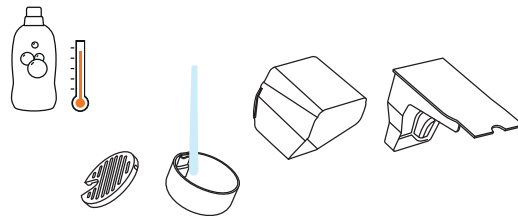

7 Lave el contenedor de cápsulas, el soporte de tazas y la bandeja de goteo con agua caliente y detergente sin aroma.

PRECAUCIÓN: No utilice agentes de limpieza abrasivos. No coloque la máquina en el lavavajillas. No sumerja el aparato o parte de él en agua.

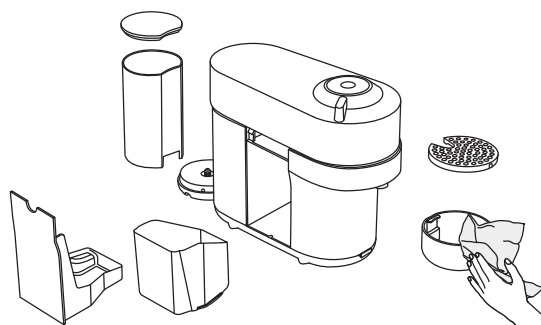

8 Seque con un paño limpio y seco

PRECAUCIÓN: Limpie la salida de café de forma regular con un paño húmedo y limpio. Siempre use paños suaves para limpiar la máquina.

NOTA: Se puede acumular agua dentro del cabezal durante el proceso de limpieza. Si esto pasa, seque las partes visibles con un paño limpio.

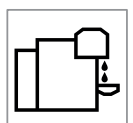

DESCALCIFICACIÓN

El proceso de descalcificación asegura que su máquina funcione apropiadamente durante su tiempo de vida y hará que su experiencia de café sea como el primer día. Su máquina le indicará cuando deba descalcificarla mediante el parpadeo de las luces en color naranja antes de la luz fija blanca.



- i** El proceso de descalcificación toma aproximadamente 20 minutos y **no puede interrumpirse.**

NOTA: Por favor lea con cuidado las instrucciones de descalcificación antes de empezar.

Necesitará:

- El kit de descalcificación disponible en www.nespresso.com
- Un contenedor vacío de al menos 1 L de capacidad

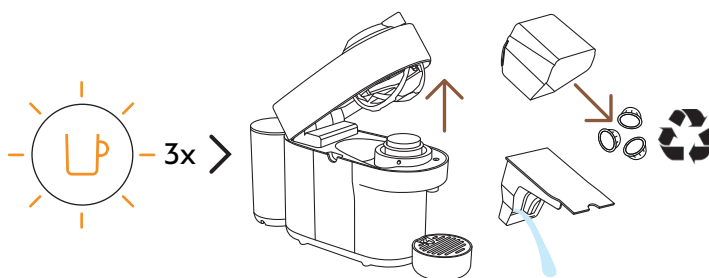

- 1** Con el botón parpadeando en naranja 3 veces: Desbloquee y abra el cabezal de la máquina y deje que la cápsula usada sea expulsada. Vacíe el contenedor de cápsulas y la bandeja de goteo y colóquelas nuevamente en su lugar. No olvide reciclar sus cápsulas **Nespresso**.*

* ESTO ES **NESPRESSO**, ES RECICLABLE. Para más información de nuestro programa de reciclaje, visite www.nespresso.com

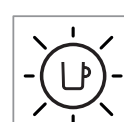
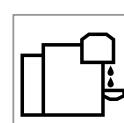
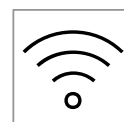

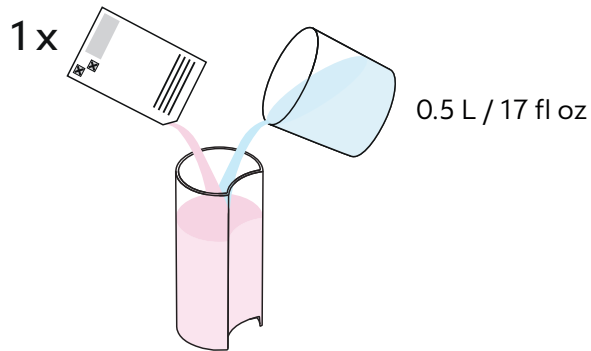

- 2** Llene el tanque de agua con 0,5 L de agua y añada 1 unidad del líquido descalcificante de **Nespresso**.

PRECAUCIÓN: La solución descalcificante puede ser dañina. Evite el contacto con los ojos, la piel y las superficies.

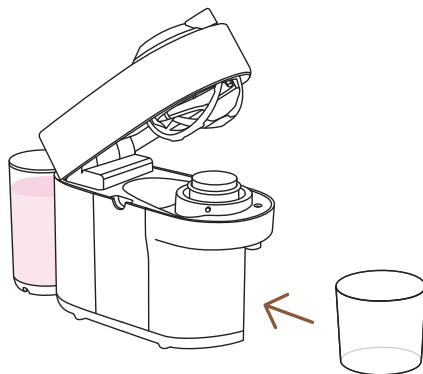

- 3** Retire el soporte de tazas y coloque un contenedor vacío de al menos 1 L de capacidad debajo de la salida de café.

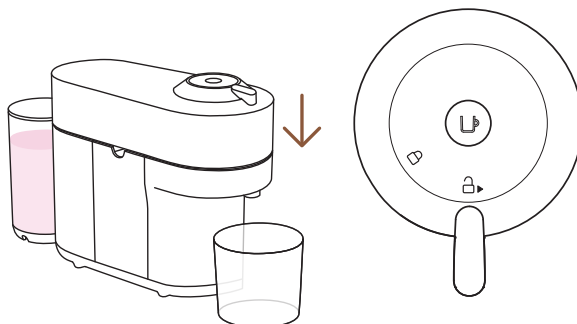

- 4** Con la máquina encendida, cierre el cabezal y mantenga la palanca en la posición de desbloqueo.

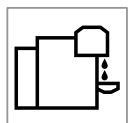

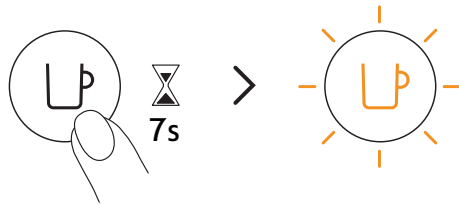

- 5** Mantenga presionado el botón durante al menos 7 segundos o hasta que vea que la luz de apague. El botón empezará a parpadear color naranja rápidamente.

PRECAUCIÓN: Cuenta con 45 segundos para entrar al modo de descalcificación, de lo contrario, la máquina regresará al modo de extracción.

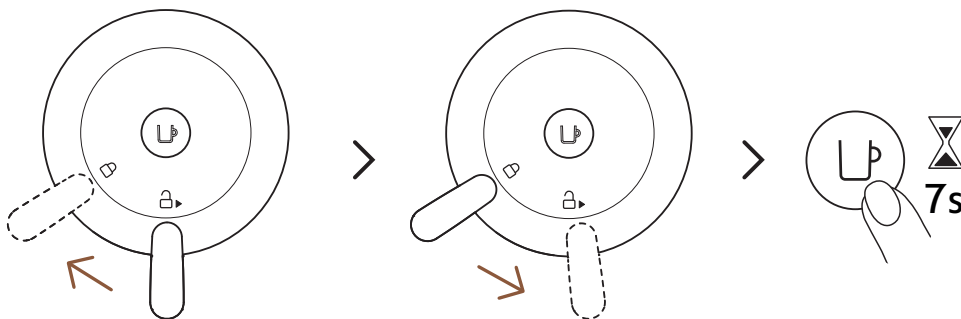

- 6** Bloquea el cabezal de la máquina girando la palanca hacia la izquierda hasta el símbolo de bloqueo y luego desbloquea la palanca girando hacia la derecha hasta la posición de desbloqueo. Mantenga el botón por al menos 7 segundos.

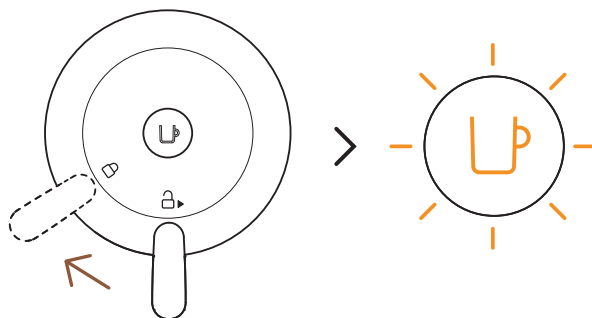

- 7** Para iniciar el modo de descalcificación, bloquee la máquina girando la palanca hacia la izquierda hasta la posición de bloqueo. La luz deberá seguir parpadearo de color naranja de forma rápida. Esta es una indicación de que se ha iniciado el modo de descalcificación.

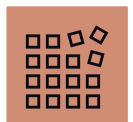

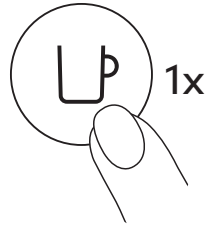

- 8** Presione el botón una vez para iniciar el proceso de descalcificación. La luz continuará parpadeando de forma constante de color naranja durante el proceso.
- i** La máquina se detendrá automáticamente cuando el proceso esté completo.

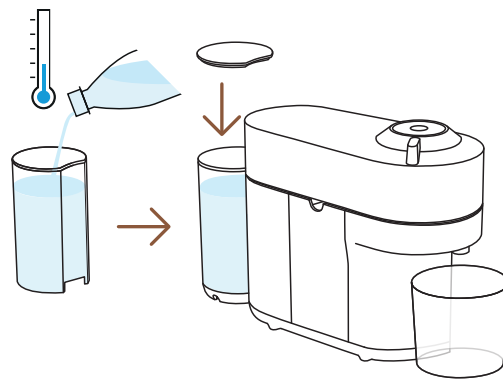

- 9** Al final del proceso de descalcificación, es momento de enjuagar la máquina. Enjuague bien el tanque de agua y la bandeja de goteo. Llene el tanque de agua con agua fresca potable y colóquelo en su lugar. Vacíe el contenedor y colóquelo en su lugar debajo de la salida de café.

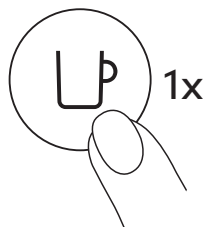

- 10** Presione el botón para enjuagar la máquina. Cuando el botón parpadee rápidamente, el proceso de descalcificación está completo.
- i** La máquina se detendrá automáticamente cuando el proceso esté completo.

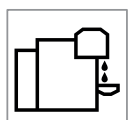
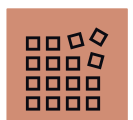

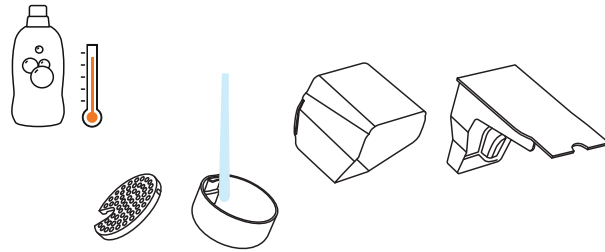

- 11** Lave el contenedor de cápsulas, el soporte de tazas y la bandeja de goteo con agua caliente y detergente sin aroma.

PRECAUCIÓN: No utilice agentes de limpieza abrasivos. No coloque la máquina en el lavavajillas. No sumerja el aparato o parte de él en agua.

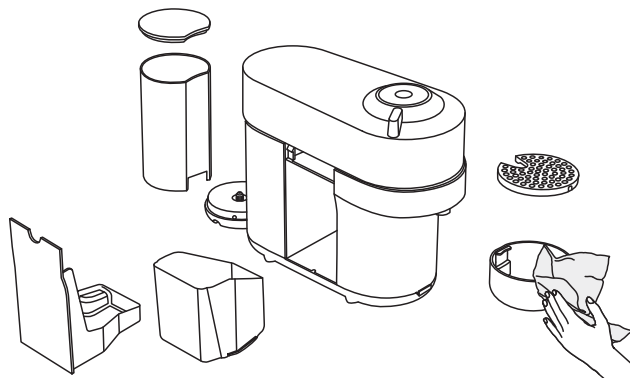

- 12** Seque la máquina con un paño limpio. Deje que la máquina se seque durante 10 minutos antes de usarla.

NOTA: Se puede acumular agua dentro del cabezal durante la limpieza, si esto pasa, seque las partes visibles con un paño limpio y seco.

NOTA: la máquina solo puede entrar en modo descalcificación luego de 30 o más cafés elaborados.



VACIADO DEL SISTEMA

El vaciado del sistema es un proceso que puede ser realizado antes de un periodo sin uso, para protección contra las heladas o previo al envío de la máquina a servicio técnico.

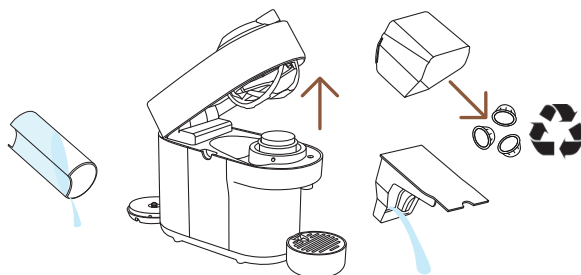

- 1** Vacíe el tanque de agua, abra el cabezal de la máquina y retire la cápsula usada. Vacíe el contenedor de cápsulas y la bandeja de goteo. No olvide reciclar sus cápsulas **Nespresso**.*

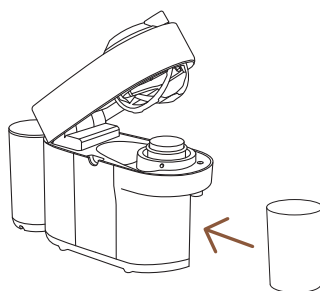

- 2** Coloque los removibles de nuevo en su lugar y retire el soporte de tazas y coloque un contenedor vacío de al menos 0,5 L de capacidad debajo de la salida de café.

* ESTO ES **NESPRESSO**, ES RECICLABLE. Para más información de nuestro programa de reciclaje, visite www.nespresso.com

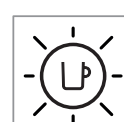
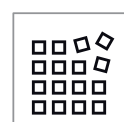
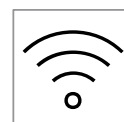

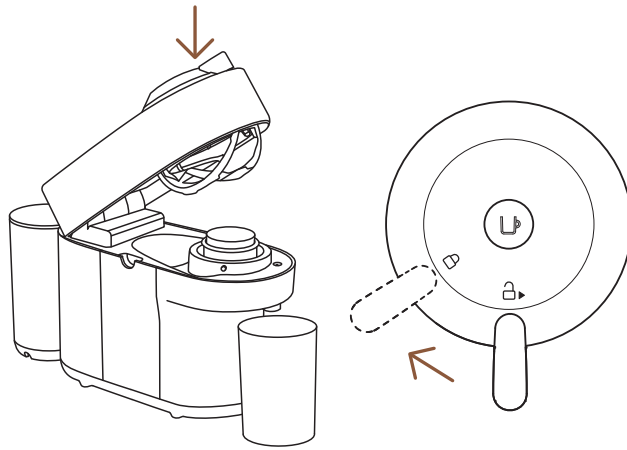

- 3** Con la máquina conectada, cierre el cabezal y coloque la palanca en la posición de bloqueo.

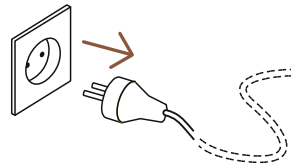

- 4** Desconecte la máquina

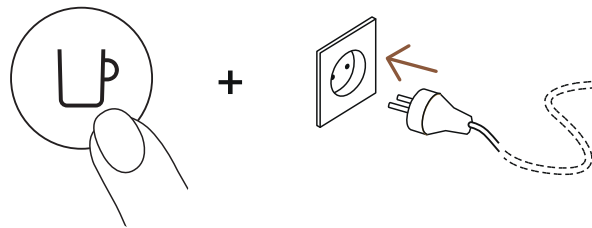

- 5** Mantenga presionado el botón mientras vuelve a conectar la máquina.

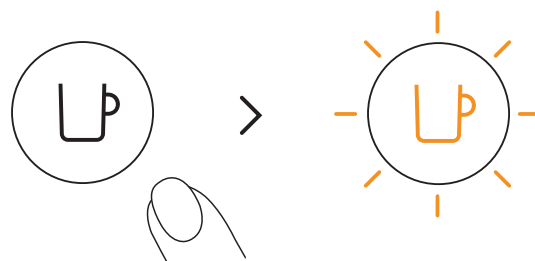

- 6** Deje de presionar el botón. Parpaderá en color naranja y se iniciará el proceso.

- i** Tomará aproximadamente 30 segundos para completar el proceso. La máquina se apaga automáticamente cuando el proceso está terminado.

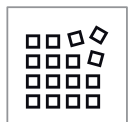

RESETEO EN LOS AJUSTES DE FÁBRICA

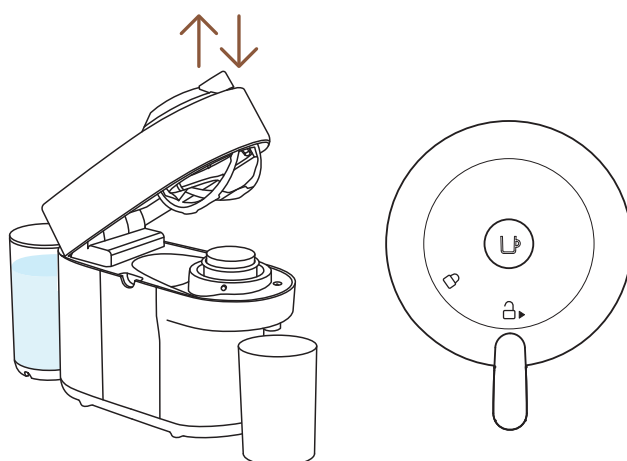

- 1 Con la máquina conectada, cierre el cabezal antes de colocar la palanca en la **posición de bloqueo**.

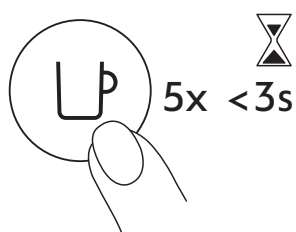

- 2 Presione el botón 5 veces en 3 segundos. La máquina ahora cuenta con los ajustes de fábrica.

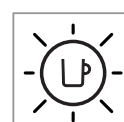
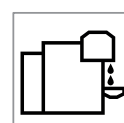
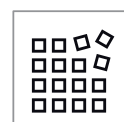
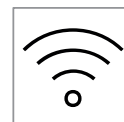

RESUMEN DEL PARPADEO

¿Desea saber más sobre el parpadeo de Vertuo Pop?
Lo invitamos a ver el siguiente video:

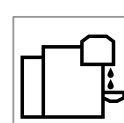
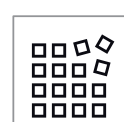
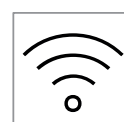

SOLUCIÓN DE PROBLEMAS

No hay luz en el botón

- La máquina se ha apagado automáticamente; presione el botón o desbloquee la máquina.
- Revise el enchufe, voltaje y fusibles.

No extrae café ni agua.

- Revise que el tanque de agua esté lleno
- Revise que una cápsula nueva esté en el compartimento y en la posición correcta, que la perilla esté correctamente bloqueada y presione el botón para iniciar.
- Descalcifique de ser necesario.
- Abra el cabezal de la máquina y deje que la cápsula sea expulsada. Realice la limpieza según la sección de limpieza.

El café no está lo suficientemente caliente

- Pre caliente la taza con agua caliente
- Descalcifique de ser necesario.

Fuga o flujo de agua inusual.

- Revise que el tanque de agua esté correctamente colocado
- Descalcifique de ser necesario.

La máquina pasa a modo OFF.

- Para ahorrar energía, la máquina se apagará después de 2 minutos sin uso.
- La máquina puede apagarse en cualquier momento al presionar el botón durante 3 segundos.

Hay restos de café en la taza.

- Realice el proceso de limpieza dos veces
- Revise la sección **“Limpieza”**.

La máquina no inicia y tiene encendida la luz. Si hay parpadeo, revise los siguientes puntos.

- Revise que la perilla esté correctamente bloqueada.
- Si desea preparar un café o Espresso, revise que una cápsula nueva está insertada en la posición correcta, que la perilla está correctamente cerrada y pulse el botón de inicio.
- Si está limpiando, descalcificando o vaciando el sistema, revise que no hay cápsulas insertadas, después cierre, bloquee la máquina y presione el botón para iniciar una de estas operaciones.

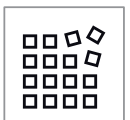

La máquina no inicia y la luz parpadea alternadamente; 1 parpadeo y 1 pausa.

La luz parpadea mientras la máquina está funcionando.

La máquina no inicia y la luz parpadea alternadamente; 1 parpadeo y 1 pausa.

- Llene el tanque de agua y presione el botón para iniciar
- Revise que la perilla esté correctamente bloqueada.
- Si el café fluye de manera normal, esto indica que la máquina funciona correctamente.
- Si solo fluye agua, la máquina está ejecutando la solicitud del usuario para la limpieza, descalcificación o vaciado del sistema. Por favor revise la sección correspondiente.
- Apague la máquina mediante la presión por 3 segundos del botón y después presiónelo de nuevo para encender la máquina. Ahora espere aproximadamente 20 minutos para permitir que la máquina se enfríe después del uso extensivo.
- Tomará un poco de tiempo antes de que el flujo de café inicie (debido a la lectura del código de barras y pre-infusión del café).
- Revise que una cápsula nueva esté en el compartimento y en la posición correcta, que la perilla esté correctamente bloqueada y presione el botón para iniciar.
- Llene el tanque de agua y presione el botón para iniciar
- Apague la máquina mediante la presión por 3 segundos del botón y después presiónelo de nuevo para encender la máquina. Ahora espere aproximadamente 20 minutos para permitir que la máquina se enfríe después del uso extensivo.

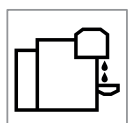

La luz parpadea alternadamente 2 veces y tiene una pausa continua. La máquina no inicia.

- Durante la preparación de café/Espreso:
 - 1) Desbloquee la máquina y abra el cabezal de la máquina para revisar que una cápsula nueva y no dañada esté insertada en la posición correcta.
 - 2) Revise que la perilla está en la posición BLOQUEADO.
 - 3) Revise que el tanque de agua esté lleno
- Durante la descalcificación, vaciado y limpieza:
 - 1) Revise que no haya cápsula insertada.
 - 2) Revise que la perilla está en la posición BLOQUEADO.
- Durante la programación del volumen:
 - 1) Revise que la cápsula está correctamente colocada
 - 2) Por favor revise la sección correspondiente.
- Si el problema persiste:
 - 1) Desbloquee la máquina y abra el cabezal.
 - 2) Reemplace la cápsula (de ser necesario).
 - 3) Desconecte el cordón de alimentación del enchufe y conéctela nuevamente después de 10 segundos.
 - 4) Cierre el cabezal y presione el botón de encendido; presiónelo nuevamente para iniciar la preparación.

Si el problema persiste, contacte **Nespresso**.

La luz parpadea alternadamente 3 veces y después se mantiene.

- La descalcificación es necesaria: la máquina puede ser utilizada algunas ocasiones más después de esta alerta hasta que la descalcificación se vuelve necesaria

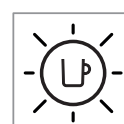
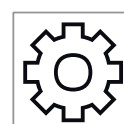
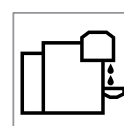
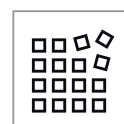
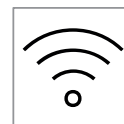

ESPECIFICACIONES

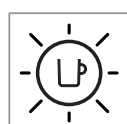
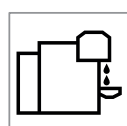
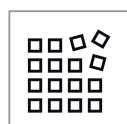
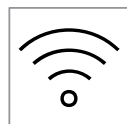

Voltaje

~220-240 V, 50-60 Hz, 1300-1500 W
US, CA: 120 V, 60 Hz, 1500 W
MX: 127 V~, 60 Hz, 1380 W

Frecuencia

2.402-2.480 GHz

RF Potencia de salida (EIRP)

Bluetooth 4 dBm Max. e.i.r.p. y Wi-Fi
 <20 dMm max. e.i.r.p.

Modo de espera

0.39 W/h

Modo ahorro de energía

Apagado automático: 2 min

Tiempo de calentamiento

30 segundos (cabezal cerrado y bloqueado)

Soporte de taza móvil para recetas grandes

Posición única extraíble

Longitud del cable del dispositivo

75 cm / 30 in

Dimensiones (W x D x H)

13.6 x 42.6 x 25 cm / 5.3 x 16.7 x 9.8 in

Peso

3.5 kg / 7.72 lbs

Capacidad del tanque de agua

600 ml / 20 fl oz

Capacidad del contenedor de cápsulas

8 espresso o 5 mug capsules

CÓDIGOS DE MÁQUINA

Nespresso

GCV2, GDV2

Breville

BNV120, BNV150

Delonghi

ENV90

Krups

XN9201, XN9204,
 XN9205, XN9211

Magimix

M800

מפרטים

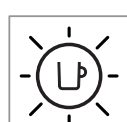
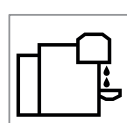
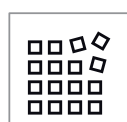
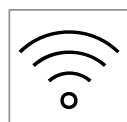

W 1500–1300 ,Hz 60–50 ,V 240–220~
W 1500 ,Hz 60 ,V 120 :US, CA
W 1380 ,Hz 60 ,~V 127 :MX

כוח

GHz 2.480–2.402

תדירות

Wi-Fi-ו eirp . מקסימום. dBm 4 Bluetooth
eirp . מקסימום. dMm 20>

כוח פלט (EIRP) RF

W/h 0.39

המתנה

כיבוי אוטומטי לאחר 2 דקות

מצב חיסכון בחשמל

30 שניות (ראש סגור ונעול)

זמן חימום

מגש ניתן להסרה

תמיכת כוס ניתנת למתכונים גדולים

75 ס"מ / 30 אינץ'

אורך כבל ממשלוח המכשיר

13.6 x 42.6 x 25 ס"מ / 5.3 x 16.7 x 9.8 אינץ'

מידות (ב D x H x)

3.5 ק"ג / 7.72 פאונד

משקל

0.6 ליטר

קיבולת מיכל מים

8 קפסולות אספרסו או 5 כוסות

קיבולת מיכל קפסולה

קודי מכונה

Nespresso

Breville

Delonghi

GDV2 ,GCV2

BNV150 ,BNV120

ENV90

Krups

Magimix

,XN9204 ,XN9201
XN9211 ,XN9205

M800

• נדרש הסרת אבנית: ניתן להשתמש במכונה רק כמה פעמים לאחר הופעת התראת הסרת האבנית לפני שיהיה צורך.

האור מהבהב לסירוגין 3 פעמים ואז דולק באופן קבוע.

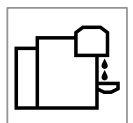

האור מהבהב בזמן שהמכונה פועלת.

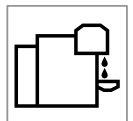

- אם הקפה זורם כרגיל, זה מצביע על כך שהמכונה פועלת כהלכה.
 - אם רק מים זורמים, המכונה מבצעת בקשת משתמש לניקוי, הסרת אבנית או ריקון המערכת. עיין בסעיף המתאים במדריך למשתמש זה.
 - סובב את המכונה למצב "OFF" על ידי לחיצה על הלחצן למשך 3 שניות ולאחר מכן לחץ עליו שוב כדי להפעיל את המכונה. כעת המתן כ-20 דקות כדי לאפשר למכונה להתקרר לאחר שימוש נרחב.
 - ייקח זמן מה עד שזרימת הקפה תצא (עקב קריאת קוד והרטבת הקפה מראש).
 - בדוק שקפסולה טרייה מוכנסת במצב הנכון, שהידיית נעולה כהלכה ולחץ על הכפתור כדי להתחיל.
 - מלא את מיכל המים ולחץ על הכפתור כדי להתחיל.
 - סובב את המכונה למצב "OFF" על ידי לחיצה על הלחצן למשך 3 שניות ולאחר מכן לחץ עליו שוב כדי להפעיל את המכונה. כעת, המתן כ-20 דקות כדי לאפשר למכונה להתקרר לאחר שימוש מרובה.
 - במהלך הכנת קפה/אספרסו רגילה:
 - (1) פתח את ידיית נעילת המכונה בכדי לבדוק שקפסולה טרייה ולא פגומה מוכנסת במיקום הנכון.
 - (2) בדוק ידיית המכונה נמצא במצב "נעול".
 - (3) בדוק שמיכל המים מלא.
 - במהלך הסרת אבנית, ריקון וניקוי:
 - (1) בדוק שהקפסולה נפלטת.
 - (2) בדוק שידיית המכונה נמצאת במצב "נעול".
 - במהלך תכנות כמות הקפה:
 - (1) בדוק אם הקפסולה הוכנסה היטב.
 - (2) אנו עיין בפרק המתאים "**התאם את גודל כוס הקפה שלך**".
 - אם הבעיה נמשכת:
 - (1) פתח את ידיית הנעילה למצב פתוח ופתח את ראש המכונה.
 - (2) החלף את הקפסולה (במידת הצורך).
 - (3) נתק את כבל החשמל מהשקע וחבר את המכשיר חזרה לשקע לאחר 10 שניות.
 - (4) סגור את ראש המכונה ולחץ על הכפתור כדי להפעיל ולחץ שוב כדי להתחיל לבשל.
- אם הבעיה נמשכת, התקשר ל-Nespresso.

האור מהבהב והמכונה לא פועלת.

האור מהבהב לסירוגין 2 הבהובים והשהייה אחת ברציפות. המכונה לא פועלת.

פתרון תקלות

- **אין אור בכפתור.**
המכונה כבתה באופן אוטומטי; לחץ על הלחצן או "בטל נעילה" של המכונה.
- בדוק את רשת החשמל, התקע, ואספקת מתח החשמל.
- **בלי קפה, בלי מים.**
בדוק שמיכל המים מלא.
- בדוק שקפסולה טרייה מוכנסת במצב הנכון, שהידיית נעולה כהלכה ולחץ על הכפתור כדי להתחיל.
- יש להסיר אבנית במידת הצורך.
- פתח את ראש המכונה ותן לקפסולה להיפלט. לאחר מכן בצע ניקוי לפי סעיף הניקוי.
- **קפה לא חם מספיק.**
מחממים את הכוס עם מי שתייה חמים מהברז.
- יש להסיר אבנית במידת הצורך.
- **דליפה או זרימת קפה חריגה.**
בדוק שמיכל המים ממוקם היטב.
- יש להסיר אבנית במידת הצורך.
- **המכונה הופכת למצב "OFF".**
כדי לחסוך באנרגיה, המכונה תכבה לאחר 2 דקות של אי שימוש.
- ניתן לכבות את המכונה באופן ידני בכל עת (כאשר אינו בשימוש) על ידי לחיצה ממושכת על הכפתור למשך 3 שניות.
- **גרגרי קפה בכוס.**
בצע את הליך הניקוי פעמיים.
- ראה סעיף בנושא "ניקוי".
- **המכונה לא מתחילה והאור דולק באופן קבוע. אם מהבהב, ראה את הנקודות הבאות.**
בדוק שהידיית נעולה כהלכה.
- אם ברצונך לחלוט קפה או אספרסו, בדוק כי קפסולה טרייה מוכנסת במיקום הנכון, ושהידיית נעולה כהלכה ולחץ על הכפתור כדי להתחיל.
- אם אתה מנקה, מסיר אבנית או מרוקן את המערכת, בדוק שלא הוכנסה כמסה ואז סגור, נעל את המכונה ולחץ על הכפתור כדי להתחיל באחת מהפעולות הללו.
- **המכונה לא מתחילה והאור מהבהב לסירוגין; הבהוב אחד והשהייה אחת.**
מלא את מיכל המים ולחץ על הכפתור כדי להתחיל.
- בדוק שידיית המכונה נעולה כהלכה.

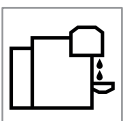
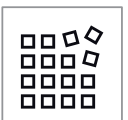

סיכום נורות התראה במערכת

אתה רוצה ללמוד עוד על נורות התראה ב Vertuo POP?
אנא צפו בסרטון הבא:

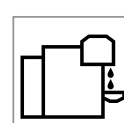
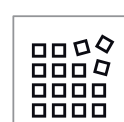
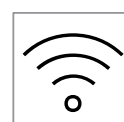

אפס להגדרות היצרן

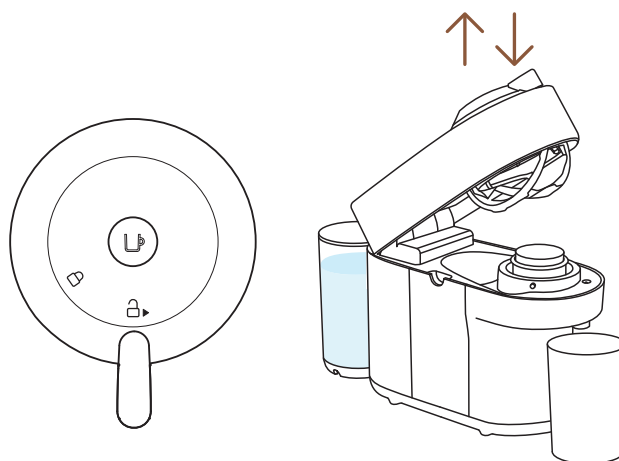

1 כשהמכונה מחוברת, פתח ואז סגור את ראש המכונה לפני השארת הידית במצב פתיחה.

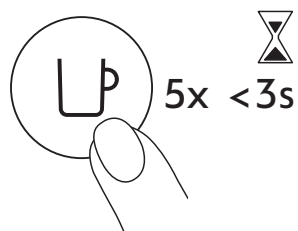

2 לחץ על הכפתור 5 פעמים תוך 3 שניות. המכונה מתוכנתת כעת עם הגדרות היצרן.

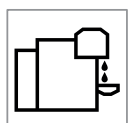

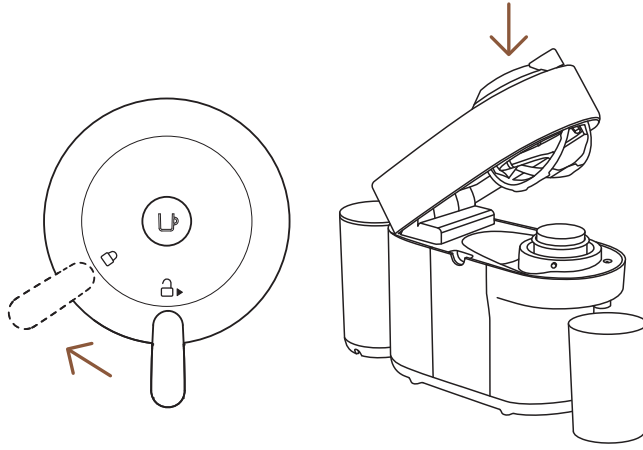

3 כאשר המכונה מחוברת לחשמל, פתח וסגור את ראש המכונה וסובב את הידית לעבר מצב הנעילה.

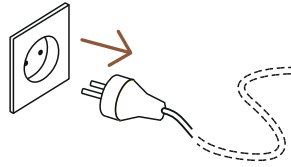

4 נתק את המכונה.

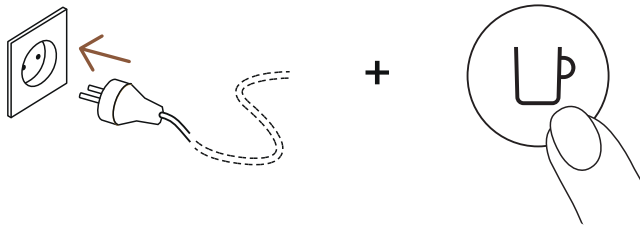

5 לחץ והחזק את הלחצן בזמן חיבור המכונה.

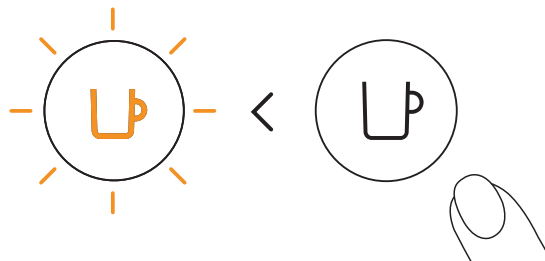

6 שחרר את הכפתור. הוא יהבהב בכתום ותהליך הריקון יתחיל.

i הערה: המכונה יכולה להיכנס למצב הסרת אבנית רק לאחר חליטה של 30 כוסות קפה או יותר.

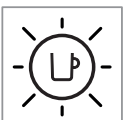
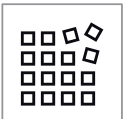
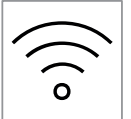

ריקון המערכת

ריקון המערכת הוא תהליך שיכול להיעשות לפני תקופה של אי שימוש, להגנה מפני כפור או לפני שליחת המכונה לתיקון.

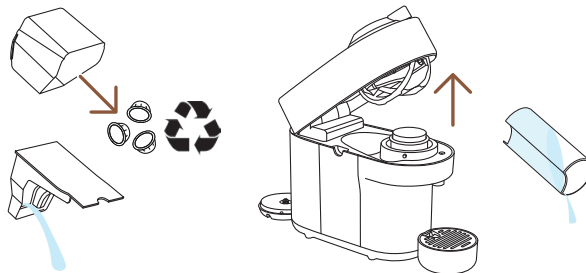

1 רוקנו את מיכל המים, פתחו את ראש המכונה ותנו לקפסולה המשומשת להיפלט. רוקן את מיכל הקפסולה ואת מגש הטפטוף. אל תשכח למחזר את קפסולות ה**נספרסו** שלך.*

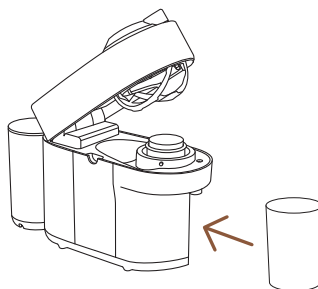

2 החזרו אותם למקומם על המכונה, הסרו את תומך הכוס והנח מיכל ריק (0.5 ליטר) מתחת לשקע הקפה.

* זה נספרסו. זה ניתן למחזור. למידע נוסף על מיחזור קפסולות Nespresso שלך, בקר בכתובת www.nespresso.com



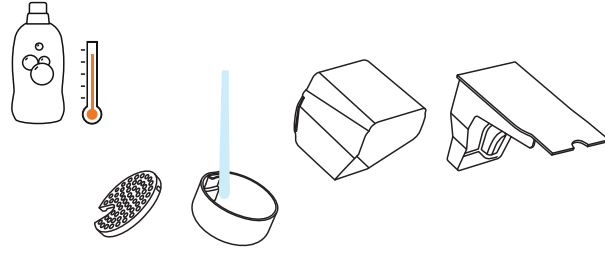

11 שטפו את מיכל הקפסולה, תומך הכוס, רשת ניקוז ואגן ניקוז במים חמים ובחומר ניקוי עדין ללא ריח.

זהירות: אין להשתמש בחומר ניקוי חזק או שוחק או בחומר ניקוי ממש. אין להכניס את המכונה למדיח כלים. לעולם אל תטבול את המכשיר או חלק ממנו במים.

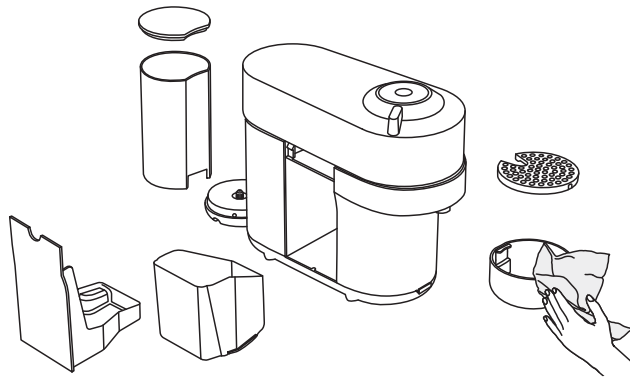

12 יבשו את המכונה במגבת נקייה וטרייה. הניחו למכונה להתייבש במשך 10 דקות לפני השימוש בה.

הערה: מים עלולים להצטבר בתוך ראש המכונה במהלך הניקוי. אם זה קורה, נא לייבש חלקים גלויים עם מטלית יבשה ונקייה.

הערה: ניתן להכניס את המכונה למצב ניקוי אבנית רק לאחר חליטת 30 כוסות קפה או יותר.

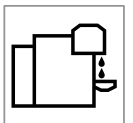

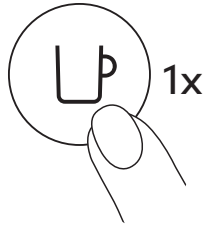

8 לחץ על לחצן הקפה פעם אחת כדי להתחיל בתהליך הסרת האבנית. האור יהבהב בכתום ללא הרף לאורך כל התהליך.

i המכונה תפסיק אוטומטית עם השלמת השלב הראשון של הסרת האבנית.

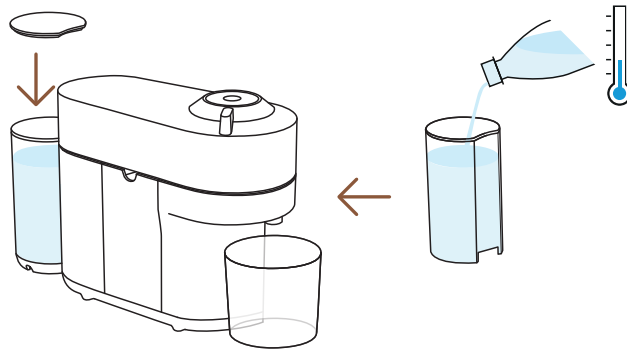

9 בתום תהליך הסרת האבנית, הגיע הזמן לשטוף את המכונה. שטפו היטב את מיכל המים ואגן ניקוז. מלאו את מיכל המים במי שתייה טריים והחזירו אותו למקומו. רוקן את המיכל והנח אותו בחזרה מתחת לשקע הקפה.

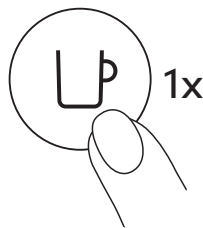

10 לחץ על הכפתור כדי לשטוף את המכונה. כאשר הכפתור מפסיק להבהב במהירות והופך יציב, הליך הסרת האבנית הושלם.

i המכונה תעצור אוטומטית עם השלמת ההליך.

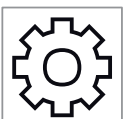
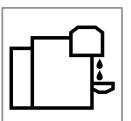
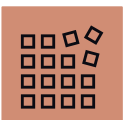

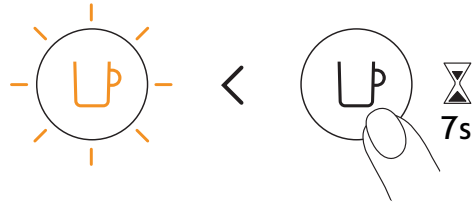

5 החזק את הכפתור למשך 7 שניות לפחות או עד שתראה את האור נכבה. הכפתור יתחיל להבהב בכתום במהירות.

זהירות: כעת יש לך 45 שניות להיכנס למצב הסרת האבנית, אחרת המכונה תחזור למצב חליטה.

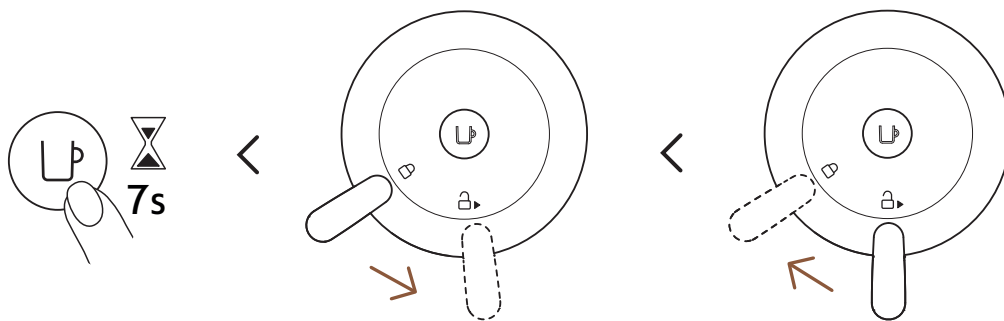

6 נעל את ראש המכונה על ידי סיבוב הידית שמאלה עד לסמל הנעילה ולאחר מכן שחרר את הנעילה על ידי סיבוב ימינה למצב פתיחה. לחץ והחזק את הלחצן שוב למשך כ-7 שניות או עד שהנורית כבה. הכפתור יתחיל להבהב בכתום במהירות.

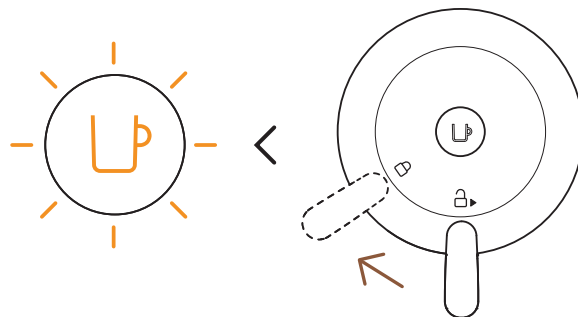

7 כדי להיכנס למצב הסרת אבנית, נעל את המכונה על ידי סיבוב הידית שמאלה לעבר מצב הנעילה. האור עדיין צריך להבהב כתום במהירות. זוהי אינדיקציה שנכנסת למצב הסרת אבנית.



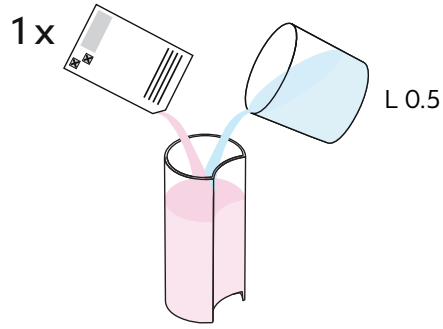

2 מלאו את מיכל המים ב-0.5 ליטר של מים והוסיפו יחידה אחת של נוזל הסרת האבנית של **Nespresso**.

זְהִירוֹת: שימו לב שתמיסת הסרת האבנית עלולה להזיק. הימנע ממגע עם עיניים, עור ומשטחים.

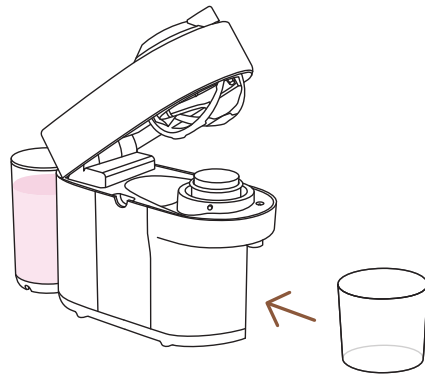

3 הסר את מגש הכוס והנח מיכל ריק (של לפחות 1 ליטר) מתחת לפתח יציאת הקפה.

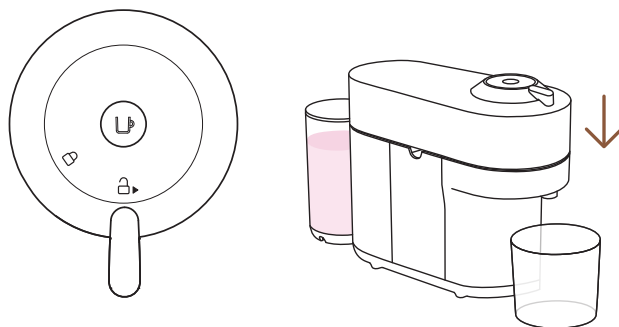

4 כשהמכונה פועלת, סגור את ראש המכונה והשאיר את הידית במצב פתיחה.

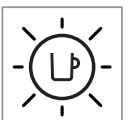
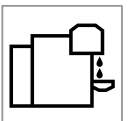
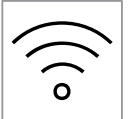

ניקוי אבנית

הסרת האבנית של המכונה שלך תבטיח שהיא תפעל כראוי לאורך כל חייה ותהפוך את חווית הקפה שלך ללא השוואה כמו שהייתה ביום הראשון. המכשיר שלך יציין מתי יש צורך בהסרת אבנית על ידי מהבהב כתום 3 פעמים לפני לבן קבוע.



i הליך הסרת האבנית נמשך ~20 דקות ולא ניתן להפריע.

הערה: אנא קרא בעיון את הוראות הסרת האבנית לפני שתתחיל.

אתה תצטרך:

- ערכת הסרת אבנית זמינה באתר www.nespresso.com
- מיכל ריק (של 1 ליטר)

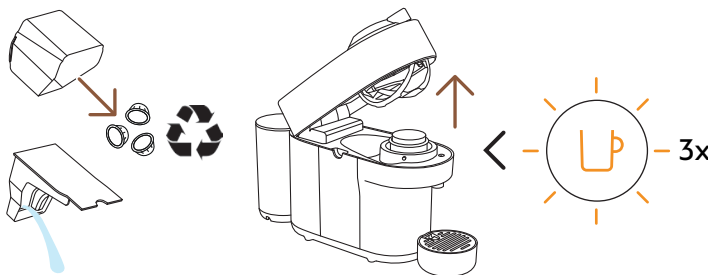

1 כשהלחצן מהבהב כתום 3 פעמים: פתח ופתח את ראש המכונה ותן לקפסולה המשומשת להיפלט. רוקן את מיכל הקפסולה ואת מגש הטפטוף והנח אותם בחזרה למקומם על המכונה. אל תשכח למחזר את קפסולות ה**נספרסו** שלך.*

* זה נספרסו. זה ניתן למחזור. למידע נוסף על מיחזור קפסולות Nespresso שלך, בקר בכתובת www.nespresso.com

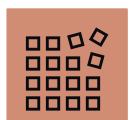

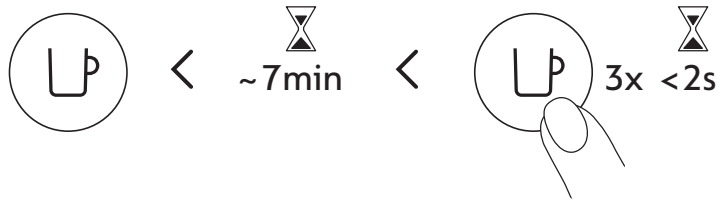

6 לחץ על הלחצן 3 פעמים תוך 2 שניות כדי להתחיל בשטיפה. כשהאור מהבהב בכתום, תן לתהליך השטיפה להסתיים באופן אוטומטי.

i זה צריך לקחת פחות מ 2 דקות לפני שתהליך השטיפה מתחיל והמים מתחילים לזרום. פעולה זו עשויה להימשך עד 7 דקות והיא תיפסק אוטומטית עם השלמת המחזור. ניתן לעצור את ההליך בכל עת על ידי לחיצה על הכפתור.

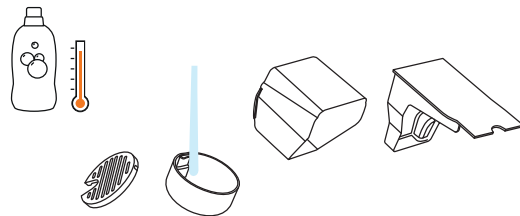

7 שטפו את מיכל הקפסולה, תומך הכוס ומגש הטפטוף במים חמים ובחומר ניקוי עדין ללא ריח.

זהירות: אין להשתמש בחומר ניקוי חזק או שוחק או בחומר ניקוי ממס. אין להכניס את המכונה למדיח כלים. לעולם אל תטבול את המכשיר או חלק ממנו במים.

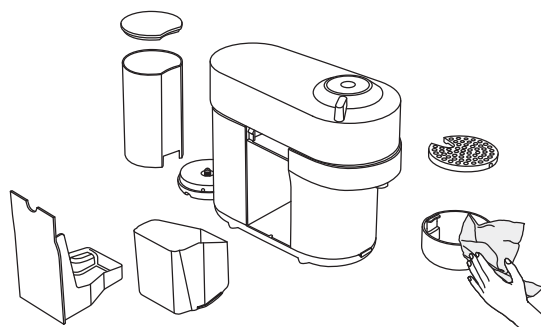

8 יבשו את המכונה במגבת נקייה וטרייה.

זהירות: נקה את פתח יציאת הקפה באופן קבוע עם מטלית לחה נקייה. השתמש תמיד במטליות רכות לניקוי המכונה.

הערות: מים עלולים להצטבר בתוך ראש המכונה במהלך הניקוי. אם זה קורה, נא לייבש חלקים גלויים עם מטלית יבשה ונקייה.

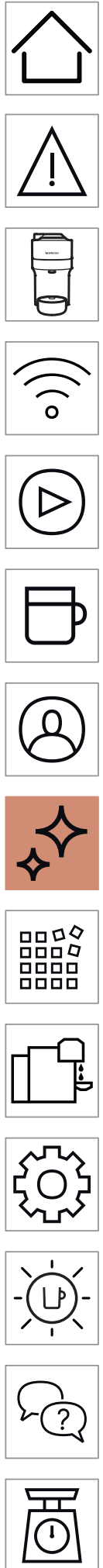

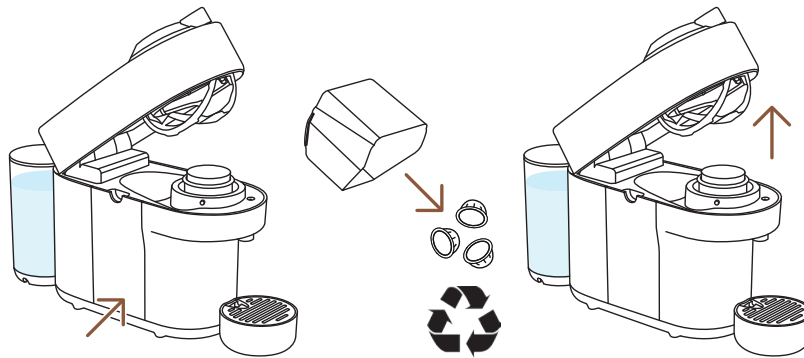

3 פתח את המכונה ותן לקפסולה המשומשת להיפלט. רוקנו ושטפו את מיכל הקפסולה ואת אגן ניקוז והחזירו אותם למקומם. אל תשכח למחזר את קפסולות הנספרסו שלך.*

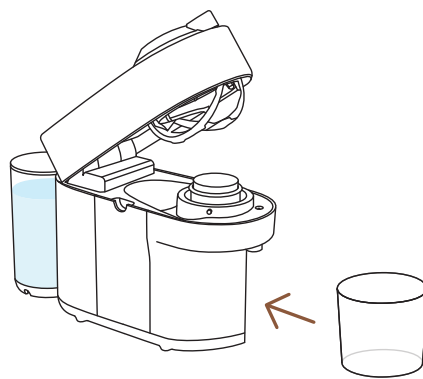

4 הסר את תומך הכוס והנח מיכל ריק (של לפחות 1 ליטר) מתחת לשקע הקפה.

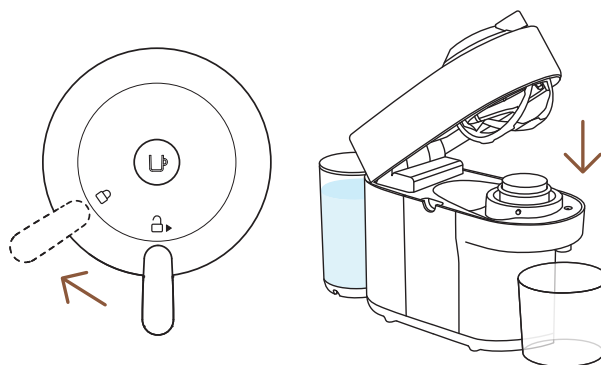

5 סגור את ראש המכונה וסובב את הידית שמאלה לעבר מצב הנעילה. ודא שאין כמוסות במכונה לפני שתתחיל את תהליך השטיפה.

* זה נספרסו. זה ניתן למחזור. למידע נוסף על מיחזור קפסולות Nespresso שלך, בקר בכתובת www.nespresso.com

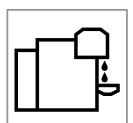

ניקוי

נקה את המכונה שלך על בסיס חודשי, כאשר מתחילים להיות שאריות קפה בתוך ראש המכונה או לאחר תקופה ארוכה של אי שימוש.

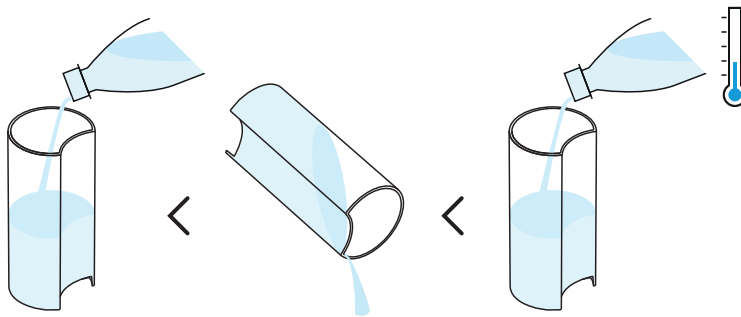

1 יש לשטוף ולנקות את מיכל המים והמכסה לפני מילוי במי שתייה טריים.

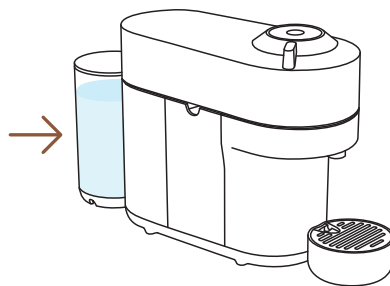

2 החזר את מיכל המים למקומו על המכונה.

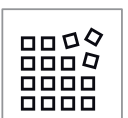

זהירות: לשימוש נכון במכונה, נא לא לפתוח את ראש המכונה בזמן שהקפה מתבשל, המתן עד שכפתור הקפה יחזור ללבן קבוע. אם ברצונך להפסיק את הבישול מוקדם יותר, אנא לחץ פעם אחת על כפתור הקפה והמתן עד שהמכונה תפסיק לפני פתיחת ראש המכונה.

הערה: ברגע שתוכנת נפח ספציפי ללקוח על ידי המשתמש, בכל פעם שסוג הקפסולה הזה יוכנס למכונה, ההכנה תיעצר בגודל הכוס שתוכנת על ידי המשתמש. אם ברצונך לחזור לפרמטרי ברירת המחדל, עיין בפסקה "איפוס להגדרות היצרן".

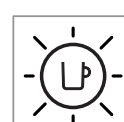
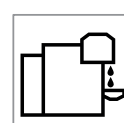
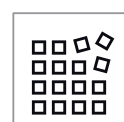
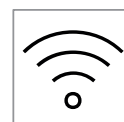

התאם את גודל כוס הקפה שלך

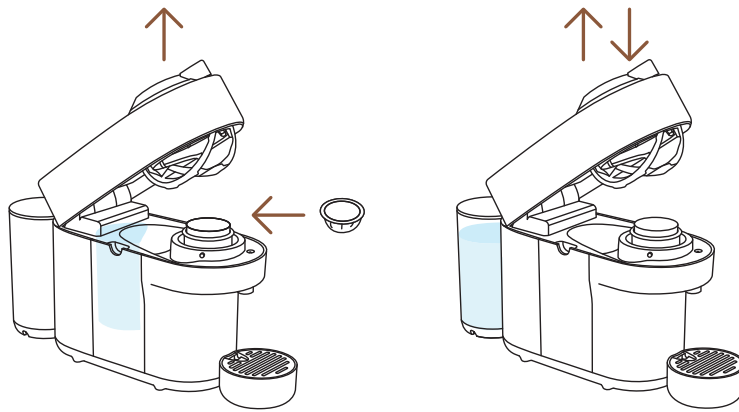

1 פתח וסגור את המכונה. עם המכונה דולקת, פתח את המכונה והכנס את הקפסולה שברצונך לתכנת.

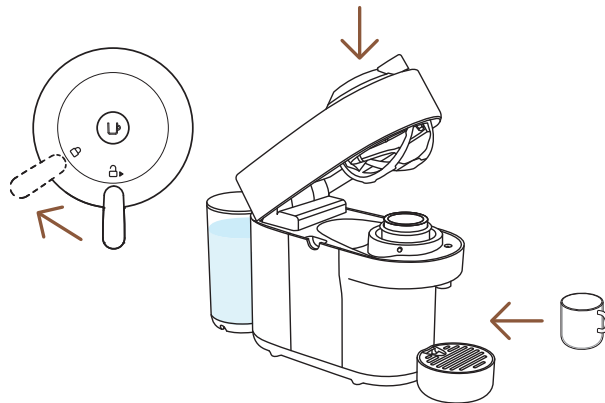

2 סגור את ראש המכונה, סובב את הידית שמאלה לעבר מצב הנועילה והנח כוס.

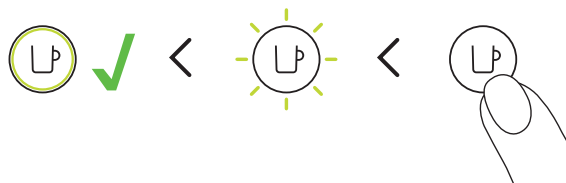

3 לחץ לחיצה ארוכה על הכפתור עד שתגיע לכמות הרצויה נפח המים החדש מתוכנת כעת עבור סוג הקפסולה המשמש במהלך ההגדרה.

i התכנות ספציפי לכל סוג קפסולה. ניתן לתכנת גדלים של כוסות מ-20 מ"ל ל-535 מ"ל.

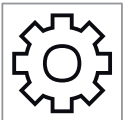
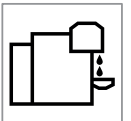
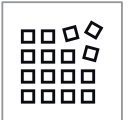
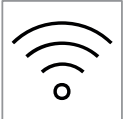

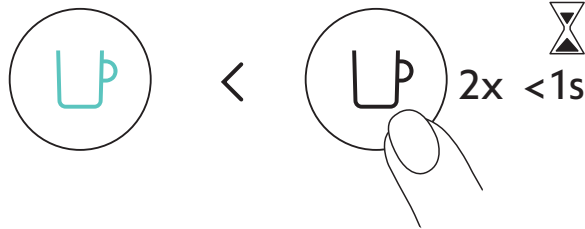

כשהמכונה פועלת, לחץ פעמיים על כפתור הקפה. הוא יהבהב בצבע טורקיז ומבשלת הקפה שלך תהיה מרוכזת, ותייעל את טעם הקפה במתכונים עם תוספות (חלב, קרם, מעל קרח...). לחוויית קפה שאין דומה לה.

ml 535	ml 355	ml 230	ml 150	ml 80	ml 40
✗	✗	✓	✓	✓	✓
		ml 80	ml 40	ml 40	ml 25

כדי ליהנות באופן מלא מהיתרונות, אנו ממליצים לחלוט את מגוון ה-Coffee+ שלנו רק בגדלים הרשמיים של הכוסות. לקבלת התוצאות הטובות ביותר בכוס, איננו ממליצים לחלוט את ה-XL שלנו (Alto Onice, Alto Ambrato), Cold Brew Style ו-Carafe Pour Over Style במצב זה.

הערה: ייתכן שיהיה צורך בעדכון של המכשיר שלך באמצעות אפליקציית **Nespresso** כדי להפעיל מצב זה.

אפשרות זאת אינה זמינה בישראל

גלה כיצד לשדרג את המכונה שלך עם מגוון Aeroccino שלנו באתר www.nespresso.com

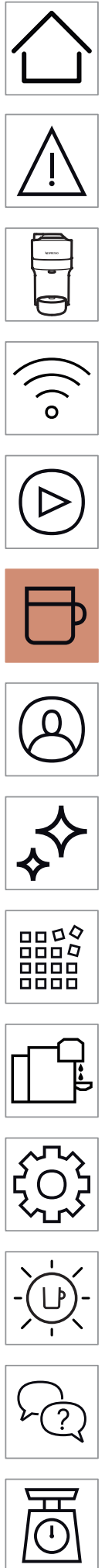
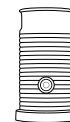

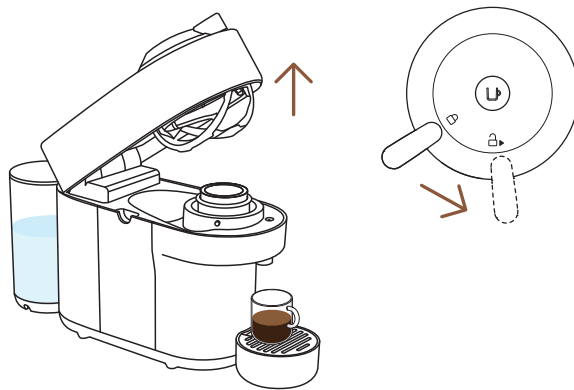

6 כאשר מסתיימת החליטה, פתח את ראש המכונה על ידי סיבוב הידית ימינה לעבר מצב פתיחה כדי להוציא אוטומטית את הקפסולה וליהנות מהקפה שלך.



7 אל תשכח למחזר את קפסולות ה**נספרסו** שלך.*

* זה נספרסו. זה ניתן למחזור. למידע נוסף על מיחזור קפסולות **Nespresso** שלך, בקר בכתובת www.nespresso.com

גלה את מצב יצירת הקפה שלנו



עם מכונה זו, **Nespresso** מציעה לך פונקציה ספציפית לרכז את מיצוי הקפה שלך כדי ליצור מתכונים משלך.

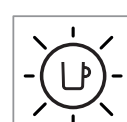
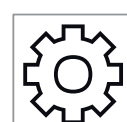
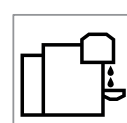
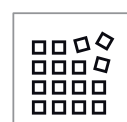
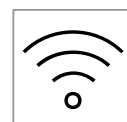

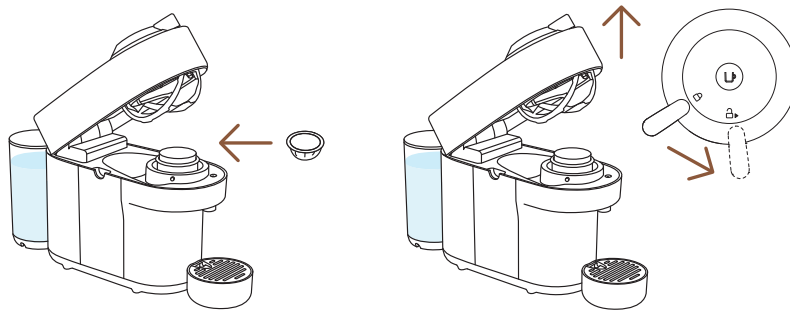

3 פתח ופתח את ראש המכונה לחלוטין והכנס קפסולת Vertuo עם צורת הכיפה כלפי מטה.

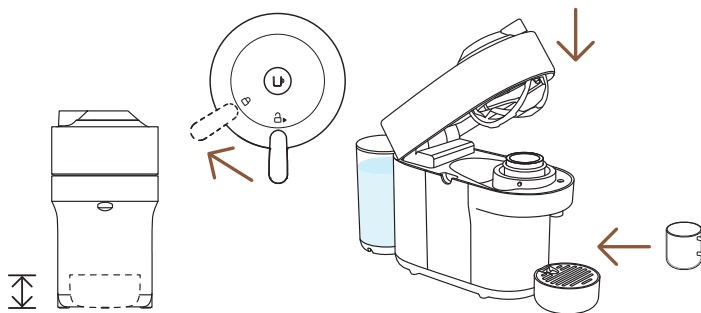

4 סגור את ראש המכונה ונעל על ידי סיבוב הידית שמאלה עד למצב הנעילה והנח כוס. ניתן להתאים את תמיכת הכוס כדי להתאים לגודל הכוס שלך.

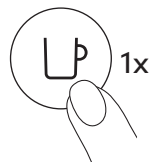

5 התחל בחליטה על ידי לחיצה על הכפתור פעם אחת.

זהירות: לשימוש נכון במכונה, נא לא לפתוח את ראש המכונה בזמן שהקפה מתבשל, המתן עד שכפתור הקפה יחזור ללבן קבוע. אם ברצונך להפסיק את הבישול מוקדם יותר, אנא לחץ פעם אחת על כפתור הקפה והמתן עד שהמכונה תפסיק לפני פתיחת ראש המכונה.

i בשל זמן קריאת קוד הקפסולה, הרטבת קפה והחליטה, ייקח רגע עד שהקפה יתחיל לזרום. המכונה תזהה אוטומטית את הקפסולה המוכנסת ותבחר את פרמטרי הכנת הקפה ואורך הכוס שהוגדרו על ידי מומחי הקפה של **Nespresso** כדי לחלץ את תערובות הקפה במיטבו.

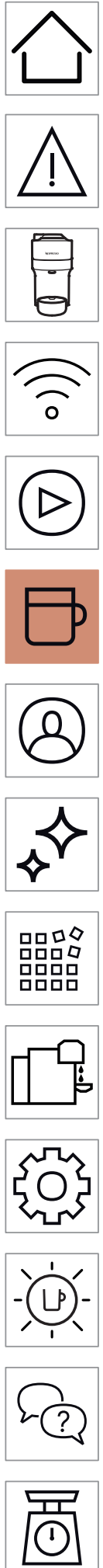

הכנת קפה

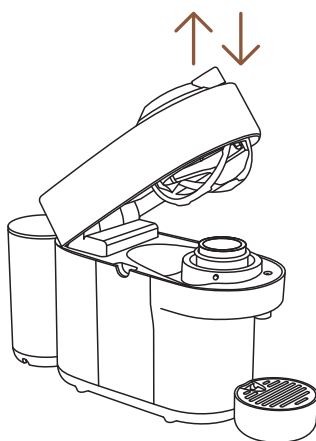

1 פתח וסגור את המכונה.

i נורית לחצן הקפה תהבהב בזמן שהמכונה מתחממת. כאשר האור הופך יציב, המכונה מוכנה לשימוש.

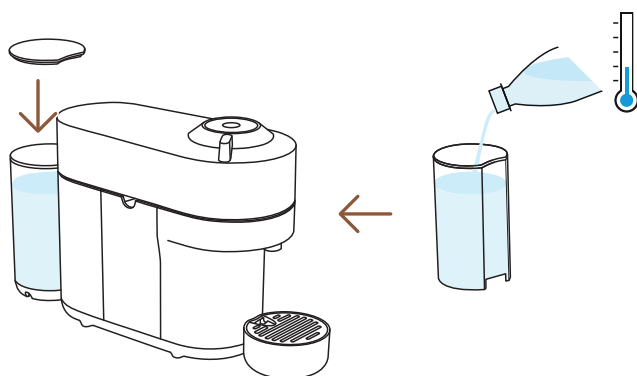

2 מלאו את מיכל המים במי שתייה טריים והחזירו אותו למקומו.

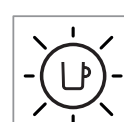
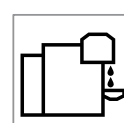
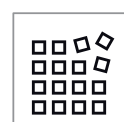
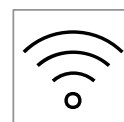

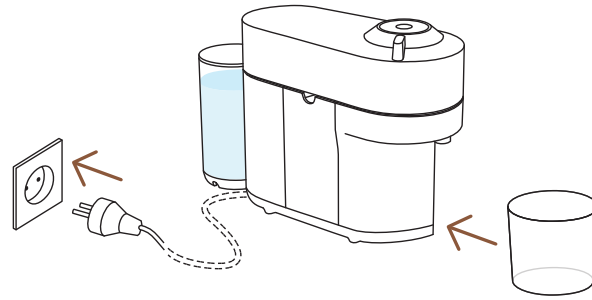

3 כשהמכונה מחוברת, הסר את תומך הכוס והנח מיכל ריק (של לפחות 1 ליטר) מתחת לשקע הקפה.

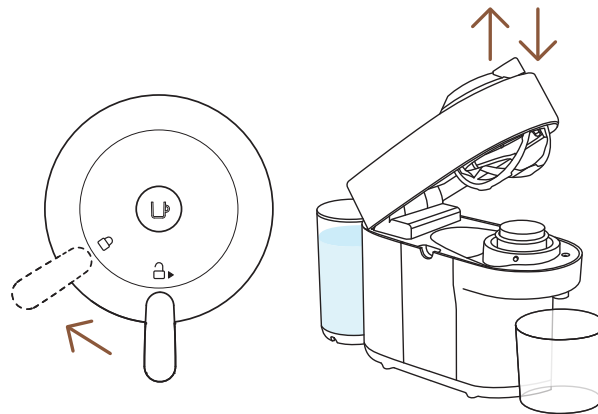

4 פתח וסגור את המכונה. ודא שהידית במצב נעילה.

i הנורית תהבהב בזמן שהמכונה מתחממת. זה ייקח בערך 30 שניות. כאשר האור הופך יציב המכונה מוכנה. ודא שלא הוכנסה כמוסה.

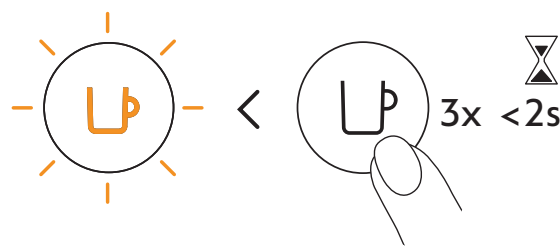

5 לחץ על הלחצן 3 פעמים תוך 2 שניות כדי להתחיל בשטיפה. כשהאור מהבהב בכתום, תן להליך השטיפה להסתיים אוטומטית. כשהאור הופך יציבלבן, המחזור הושלם.

i זה אמור לקחת פחות מ-2 דקות לפני שמתחיל תהליך השטיפה והמים מתחילים לזרום. הליך זה עשוי להימשך עד 7 דקות.



צעדים ראשונים

שטיפה ראשונה

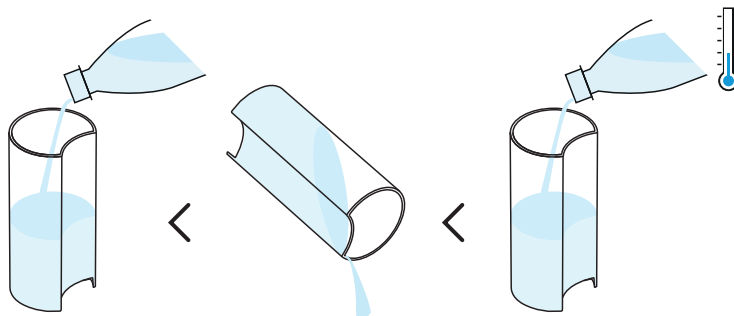

1 תחילה יש לשטוף ולנקות את מיכל המים והמכסה לפני מילוי במי שתייה טריים.

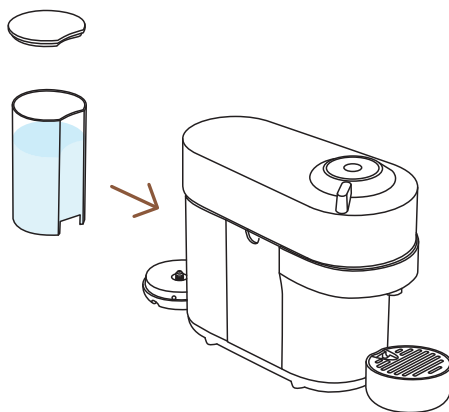

2 סגור את מיכל המים עם המכסה והכנס את מיכל המים למקומו וודא שהוא מחובר כהלכה.

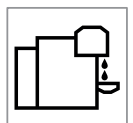

השבתת BLUETOOTH ו-WIFI במכונת הקפה

המכשיר מגיע עם מודול קישוריות, המופעל כברירת מחדל. זה נותן גישה לתכונות נוספות, מה שמשפר את חוויית הקפה שלך. כדי להשבית את מודול הקישוריות, בצע את השלבים הבאים:

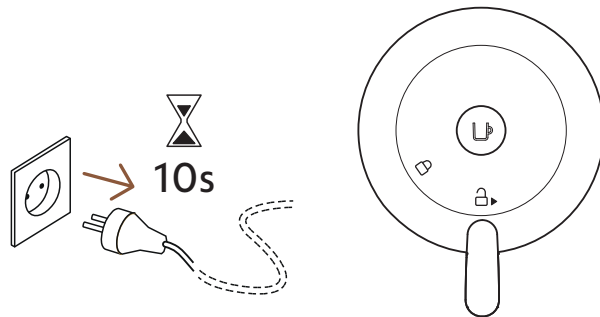

1 כשהמכונה סגורה והידית במצב לא נעול, נתק את המכונה מהחשמל למשך 10 שניות לפחות.

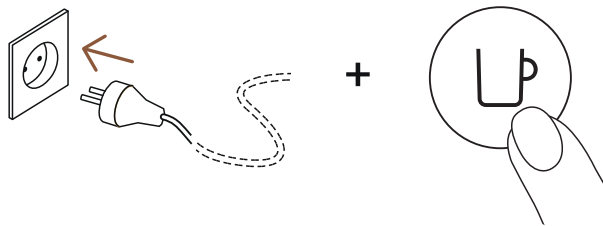

2 לחץ והחזק את הלחצן תוך כדי חיבור המכונה. הלחצן יבהב בכתום כדי לאשר שמודול הקישוריות הושבת כעת.

i בצע את אותם השלבים כדי להפעיל שוב את מודול הקישוריות. הלחצן יבהב לבן כדי לאשר שהמודול הופעל מחדש.

קישוריות אינה זמינה בישראל

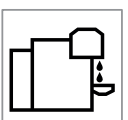
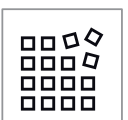

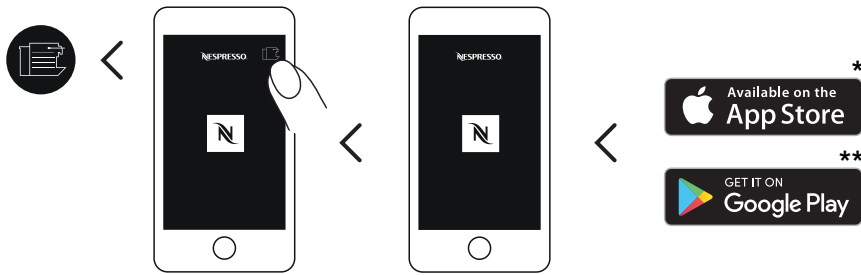

1 הורד או עדכן את אפליקציית **Nespresso**. הפעל את אפליקציית **Nespresso** בסמארטפון או בטאבלט. לחץ על סמל המכונה בפינה השמאלית העליונה של המסך.

הערה: לביצועים מיטביים וחוויה חלקה, אנו ממליצים לחבר את המכשיר שלך לנתב Wi-Fi במקום להשתמש בנקודה חמה של סמארטפון.

קישוריות אינה זמינה בישראל

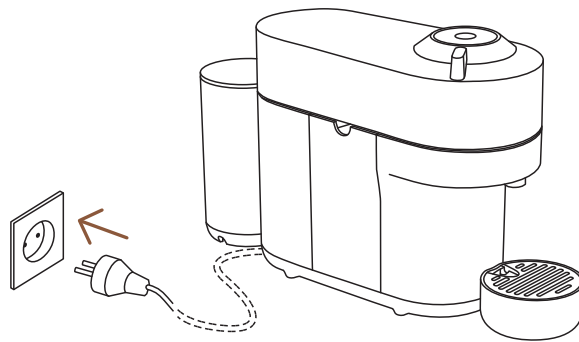

2 חבר את כבל החשמל.



3 עקוב אחר ההוראות דרך אפליקציית **Nespresso**.

זהירות: קרא תחילה את אמצעי הבטיחות כדי למנוע סיכונים של התחשמלות קטלניות ואש. אנא ודא שקיימת הארקה בעת חיבור המכונה לשקע החשמל.

* © Store App הוא סימן מסחרי של Inc Apple, הרשום בארה"ב ובמדינות אחרות.
 ** Google LLC של מסחריים סימנים הם Google Play של והלוגו Google Play

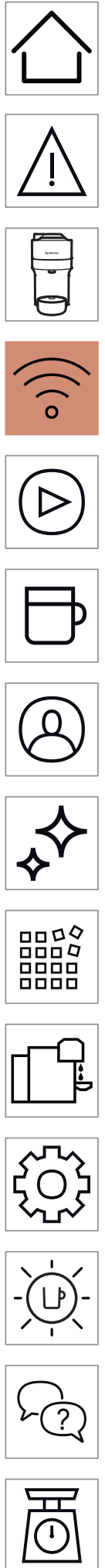

קישוריות

למה כדאי לך להצמיד את מכונת VERTUO POP שלך?
קישוריות אינה זמינה בישראל



היתרונות של חיבור מכונת VERTUO POP שלך

- **קפה חכם:** הישאר תמיד צעד אחד קדימה כדי לקבל את העדכונים העדכניים ביותר על **חידושי** הקפה שלנו מבית נספרסו על ידי שמירה על המכונה שלך על הקצה העליון ומעודכן
- **עצת מומחה:** קבל תמיכה וסרטוני הדרכה פשוטים שילוו את מסע הקפה שלך דרך הטלפון החכם שלך
- **טיפול במכונה:** קבל הודעה מיידית על איך ומתי לטפל במכונה שלך עם מדריך פשוט על הסרת אבנית, שטיפה, ניקוי וכו'.

כיצד לחבר את מכונת VERTUO POP שלך?

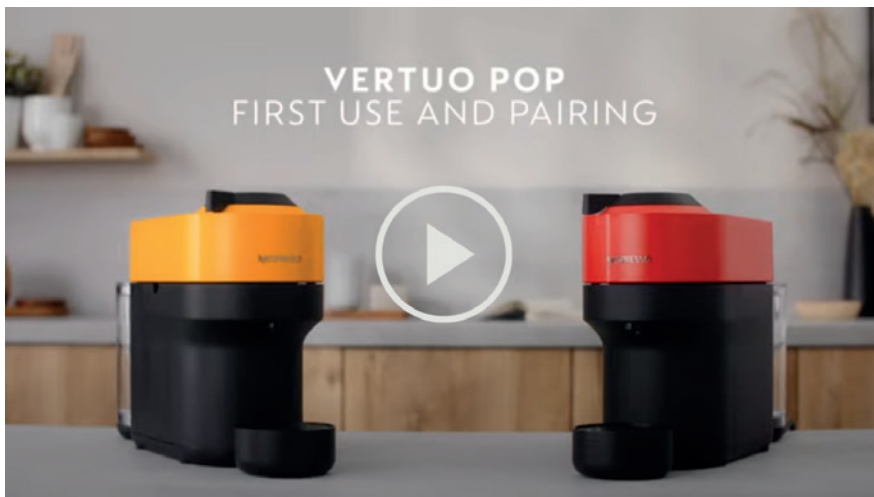

כיבוי והדלקה

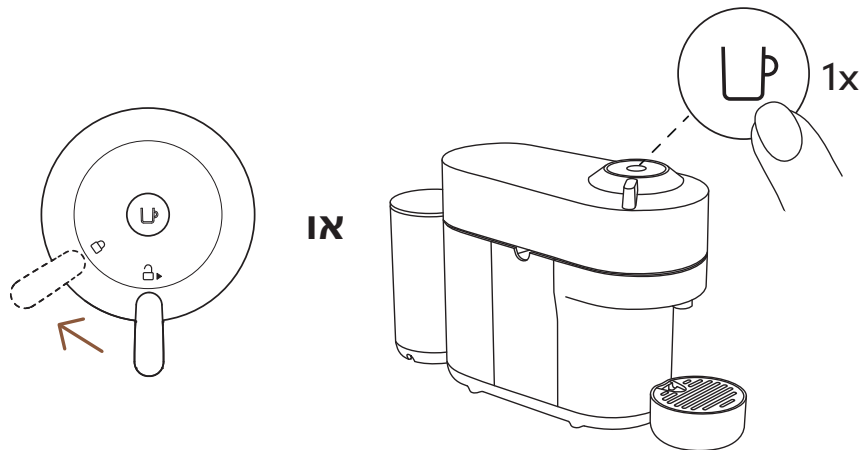

הדלקה

לאחר שהמכונה מחוברת, הפעל על ידי לחיצה על הכפתור פעם אחת או על ידי סגירת הידית במצב נעילה (עם הראש סגור).

i הנורית תהבהב במשך כ-30 שניות בזמן שהמכונה מתחממת. ברגע שהאור יציב, המכונה מוכנה לשימוש.

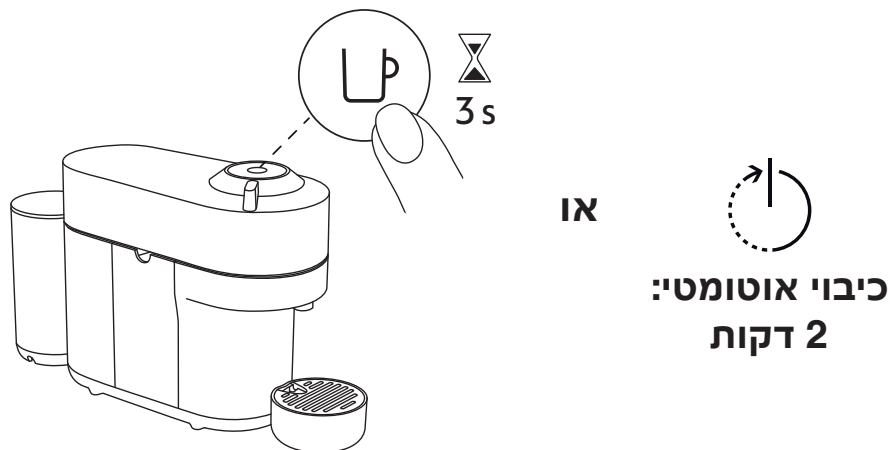

כיבוי

כדי לחסוך באנרגיה, המכונה תכבה אוטומטית לאחר 2 דקות של אי שימוש.

i ניתן לכבות את המכונה באופן ידני בכל עת (כאשר אינו בשימוש) על ידי לחיצה ממושכת על הכפתור למשך 3 שניות.

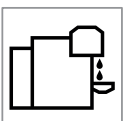
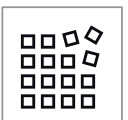

פתיחה / סגירה

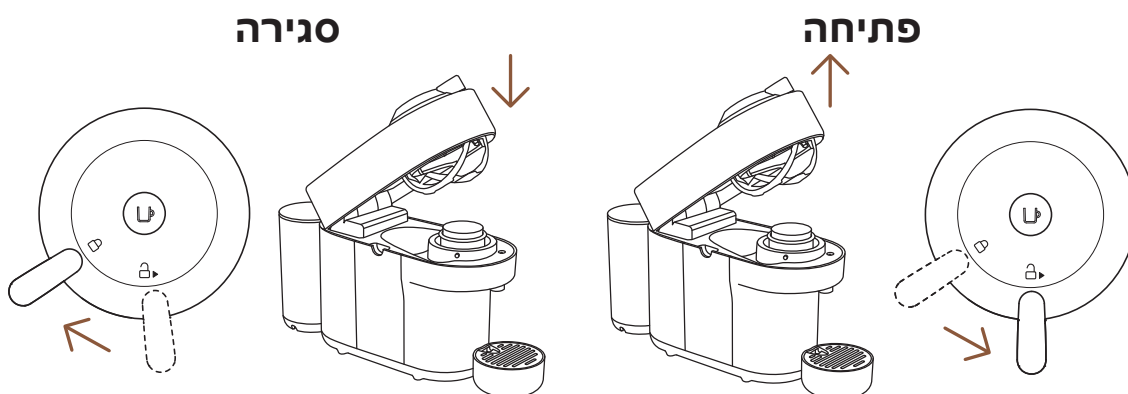

זהירות: לשימוש נכון במכונה, נא לא לפתוח את ראש המכונה בזמן שהקפה מתבשל, המתן עד שכפתור הקפה יחזור ללבן קבוע. אם ברצונך להפסיק את הבישול מוקדם יותר, אנא לחץ פעם אחת על כפתור הקפה והמתן עד שהמכונה תפסיק לפני פתיחת ראש המכונה.

מערכת VERTUO

קפסולות תואמות

XL
אלטו חליטה בסגנון קר
(ml 355)
קארף
(ml 535)

L
מאג
(ml 230)

M
אספרסו כפול
(ml 80)
לונגו
(ml 150)

S
אספרסו
(ml 40)

אביזרים מתאימים



✓
אביזרים מתאימים



✗
אביזרים לא תואמים

גלה את קולקציית האביזרים המלאה שלנו באתר

www.nespresso.com

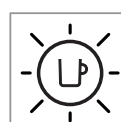
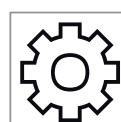
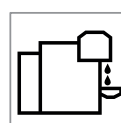
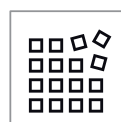
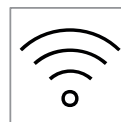

סקירת מכונה

סקירת המכונה

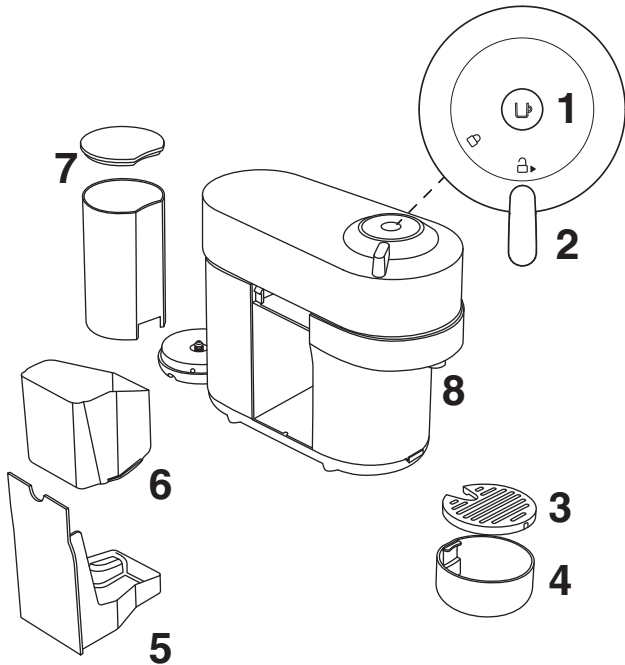

- 1 כפתור הפעלה/כיבוי וכפתור קפה
- 2 ידית נעילה/פתיחה
- 3 רשת ניקוז
- 4 תמיכת כוס מתכווננת
- 5 אגן ניקוז
- 6 מיכל קפסולות משומשות
- 7 מיכל מים ומכסה
- 8 פתח יציאת הקפה



תוכן אריזה



- 1 מכונת קפה
- 2 מארז קפסולות נספרסו
- 3 מידע על נספרסו
- 4 הוראות בטיחות
- 5 מדריך להתחלה מהירה
- 6 אחריות

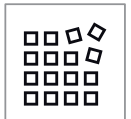

לאחר פתיחת האריזה: ייתכן שפני המכונה יהיו מאובקים עקב החומרים הממוחזרים שמהם עשויה האריזה, אם יש מעט אבק נא נגב אותו בעזרת מטלית רכה.

בטיחות

זהירות: לפני הפעלת מכונת הקפה, יש לעיין בעלון הוראות **הבטיחות בכדי** להימנע מנזק ופגיעה אפשריים.

מיחזור והגנת הסביבה

מכשיר זה תואם גם את התקן EC/19/2012. של האיחוד האירופי חומרי האריזה והמכונה מכילים חומרים הניתנים למיחזור. המכשיר שלכם מכיל חומרים בעלי ערך הניתנים לשחזור או למיחזור. הפרדת חומרי הפסולת הנותרים לסוגים שונים מאפשרת מיחזור של חומרי גלם בעלי ערך. השאירו את המכשיר בנקודת איסוף. באפשרותכם לקבל מידע בנושא מיחזור מן הרשויות המקומיות באזורכם.

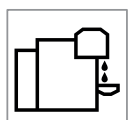

לחץ ובחר את השפה שלך

HE

בטיחות	
סקירה כללית	
קישוריות (לא זמין בישראל)	
צעדים ראשונים	
הכנת קפה	
התאם את כמות הקפה שלך	
ניקוי	
ניקוי אבנית	
ריקון המערכת	
אפס להגדרות היצרן	
סיכום נורות התראה במערכת	
פתרון תקלות	
מפרט טכני	

