



# VERTUO PLUS



NESPRESSO

# 언어를 선택해 주십시오

KR



안전 수칙



개요



처음 사용하기



커피 추출하기



추출량 설정하기



청소하기



디스케일링



머신 내부의 물 비우기



공장 출하 설정값으로 초기화



문제 해결



제품 사양

## 안전 수칙

**주의:** 상해나 위험을 방지하기 위하여 제품을 사용하기 전에 반드시 안전 수칙을 참조 하십시오.

### 머신 폐기 및 환경 보호

이 머신은 유럽연합(EU) 지침 2012/19/EC 를 준수합니다.  
포장재 및 머신은 재활용 가능한 재료들을 포함하고 있습니다.  
폐기시 원재료별로 분리 배출하면 재활용이 쉬워집니다. 소형 폐  
가전 머신 무상 수거 등을 이용하여 머신을 폐기할 수 있습니다.  
머신 폐기에 관한 정보는 거주지 관할 관청에서 얻으실 수  
있습니다.

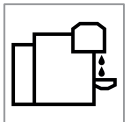

# 개요

**주의:** 먼저 치명적인 전기 감전 사고 및 화재를 예방하기 위해 안전 수칙을 확인하십시오. 반드시 접지된 콘센트에 머신을 연결하여 사용하십시오.

## 각 부분별 이름

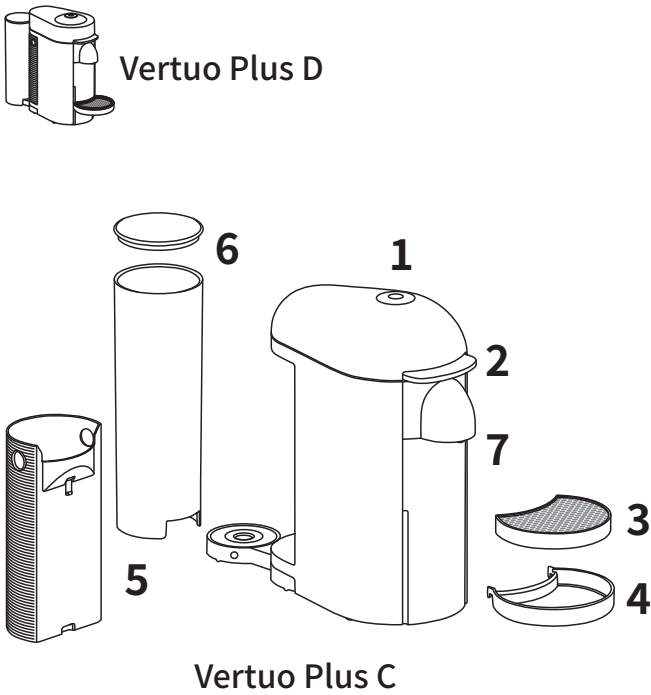

- 1 전원/커피 버튼
- 2 열기/닫기 레버
- 3 드립 그리드
- 4 높이 조정이 가능한 컵 받침
- 5 캡슐 컨테이너
- 6 물통과 뚜껑
- 7 커피 추출구

## 제품 구성



- 1 커피 머신
- 2 네스프레소 웰컴 기프트 커피
- 3 네스프레소 웰컴 안내 책자
- 4 안전 수칙
- 5 간단 사용 설명서
- 6 제품 보증서

**i 박스 개봉:** 재활용된 포장재 사용으로 인해 머신 표면에 먼지가 있을 수 있습니다. 위험한 물질이 아니니, 깨끗한 종이 타월로 닦아 주십시오

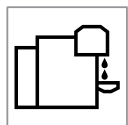
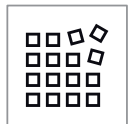

# 헤드 열기 / 닫기

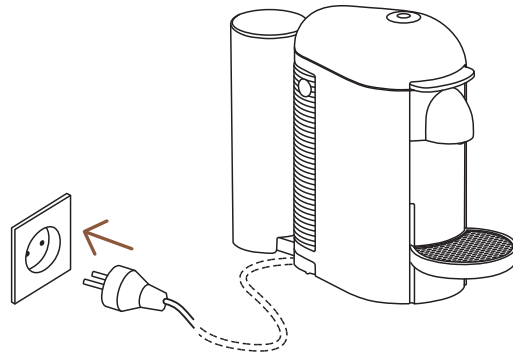

**1** 전원 플러그를 연결합니다.

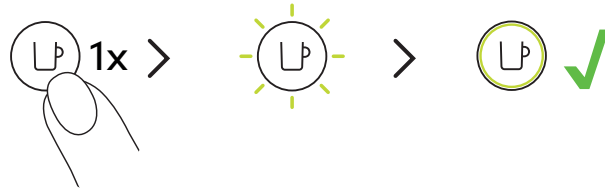

**2** 버튼을 한번 눌러 머신의 전원을 켭니다.

**3**                    **헤드 열기**

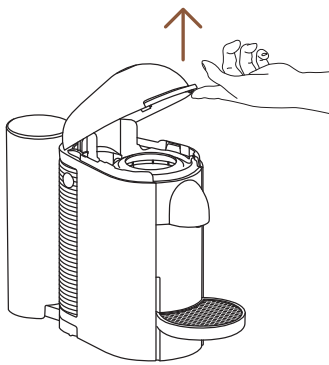

**헤드 닫기**

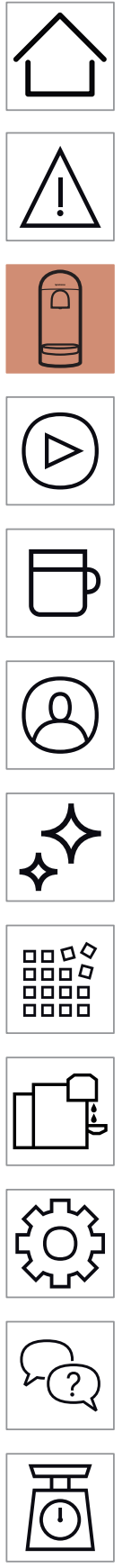
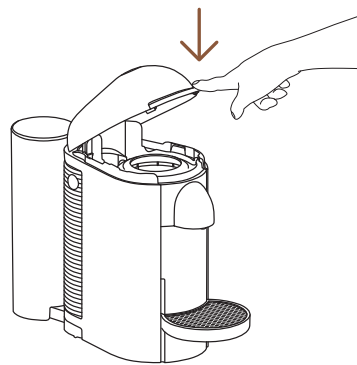

**주의:** 먼저 치명적인 전기 감전 사고 및 화재를 예방하기 위해 안전 수칙을 확인하십시오. 반드시 접지된 콘센트에 머신을 연결하여 사용하십시오.

## 버추오 커피 시스템

### 캡슐 호환 여부



  
에스프레소  
(40 ml)

  
M  
더블 에스프레소  
(80 ml)  
그랑 룡고  
(150 ml)

  
L  
머그  
(230 ml)



  
XL  
알토, 콜드 브루  
(355 ml)  
카라프  
(535 ml)

### 액세서리 호환 여부



액세서리 호  
환 여부



에스프레소



더블 에스프  
레소



그랑 룡고



머그 (S)



머그 (M)



리벨 콜드  
글라스



사용에 적합  
하지 않은 액  
세서리



머그 (L)



카라프

[www.nespresso.com](http://www.nespresso.com) 에서 모든 액세서리 컬렉션을  
확인하십시오.



# 켜기/끄기

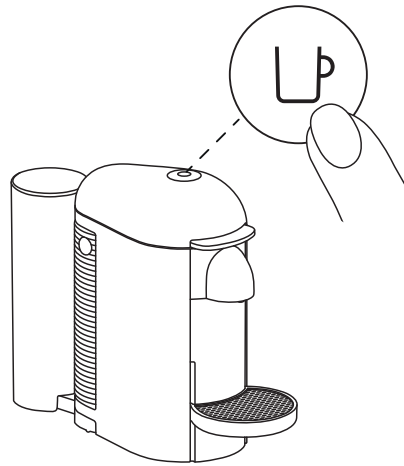

## 켜기

머신의 전원 플러그를 연결하고, 버튼을 한번 눌러 전원을 켭니다.

**i** 머신은 약 40초 동안 예열되며, 예열되는 동안 불빛이 깜빡입니다. 불빛이 계속 켜져 있으면, 머신은 사용할 준비가 된 것 입니다.

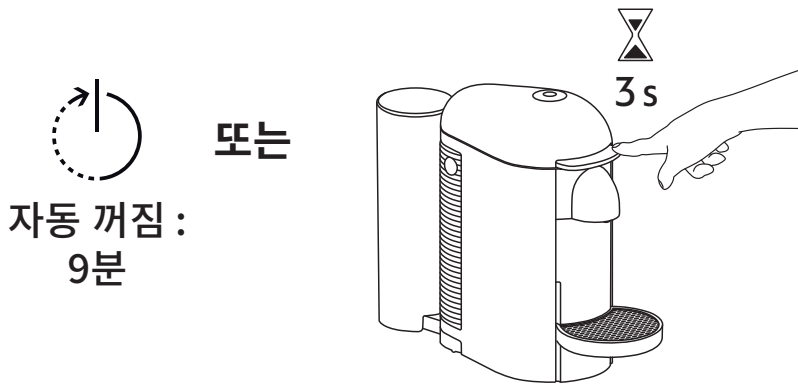

## 끄기

에너지 절약을 위해 9분 동안 머신을 사용하지 않으면 자동으로 전원이 꺼집니다.

**i** 레버를 3초간 아래로 눌러 머신의 전원을 끌 수 있습니다.

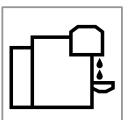
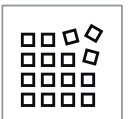

# 처음 사용하기

## 처음 사용시 세척하기

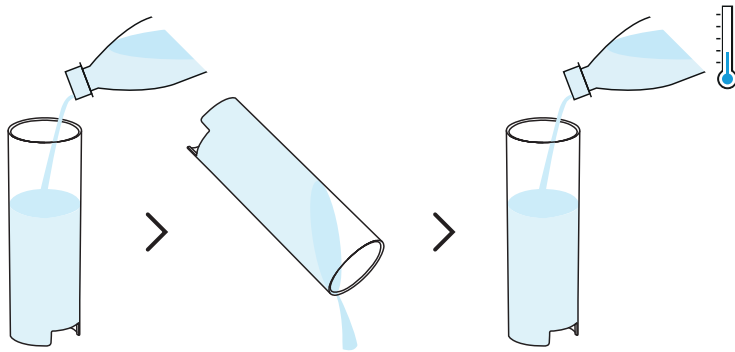

**1** 먼저 물통과 뚜껑을 깨끗한 물로 헹구고 깨끗한 음용수로 물통을 채웁니다.

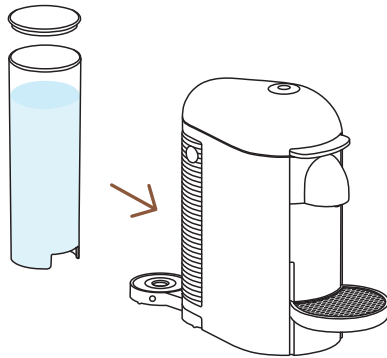

**2** 물통 뚜껑을 닫고 물통을 머신에 올바르게 장착합니다.

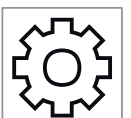
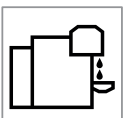



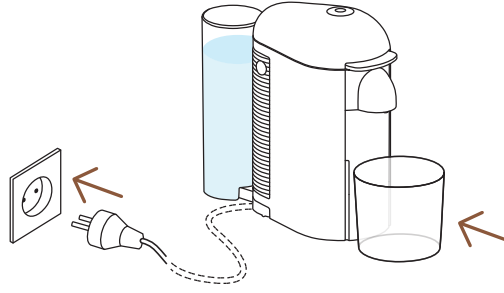

**3** 전원 플러그를 연결하고, 컵 받침을 제거합니다. 커피 추출구 아래에 1 L 이상의 빈 용기를 놓습니다.

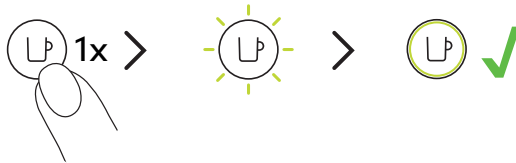

**4** 버튼을 한번 눌러 전원을 켭니다.

**i** 머신은 약 40초 동안 예열됩니다.

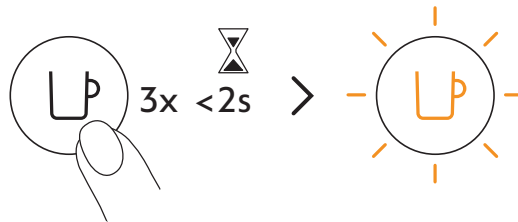

**5** 버튼을 2초 이내에 3번 누릅니다. 주황색 불빛이 깜빡이고, 행굼 과정이 자동으로 완료되도록 기다립니다. 녹색 불빛이 계속 켜져 있으면, 행굼 과정이 완료된 것 입니다.

**i** 행굼 과정을 시작하고 2분 이내에 커피 추출구로 뜨거운 물이 나오기 시작합니다. 행굼 과정은 최대 5분이 소요됩니다.

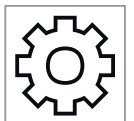
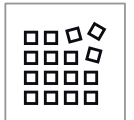

# 커피 추출하기

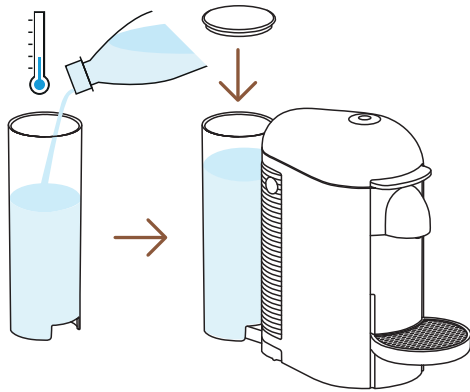
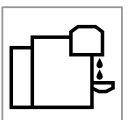
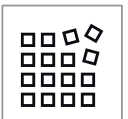

**1** 깨끗한 음용수로 물통을 채우고 물통을 머신에 올바르게 장착합니다.

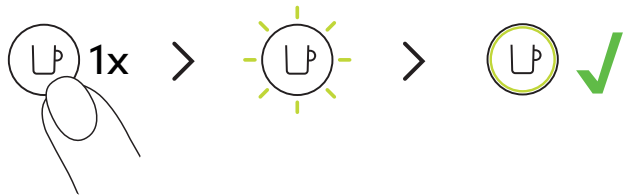

**2** 버튼을 한번 눌러 전원을 켭니다.

**i** 머신이 예열되는 동안 녹색 불빛이 깜빡입니다. 머신은 약 40초 동안 예열됩니다. 녹색 불빛이 계속 켜져 있으면, 머신은 사용할 준비가 된 것입니다.

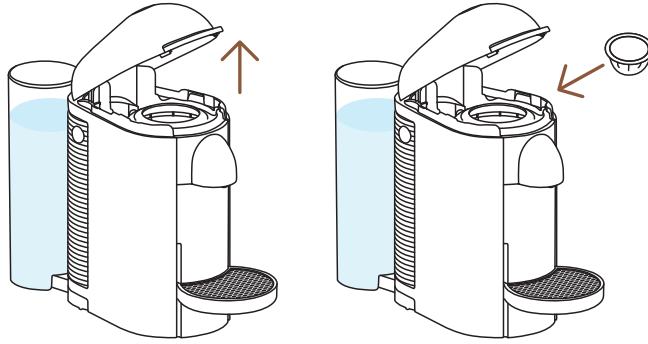

**3** 머신 헤드를 열고 둥근 모양이 아래를 향하도록 버추오 캡슐을 넣습니다.

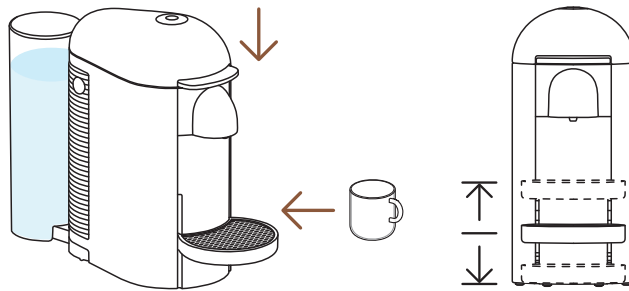

**4** 머신 헤드를 닫고 커피 추출구 아래에 컵을 놓습니다. 컵 받침의 위치를 알맞게 조정합니다.

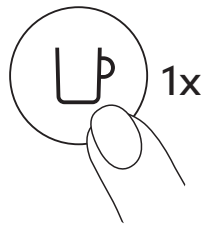

**5** 커피 버튼을 눌러 커피를 추출합니다.

**i** 바코드를 읽고 프리 인퓨전 과정을 진행하기 때문에 커피가 추출되기까지 약간의 시간이 소요됩니다. 머신은 투입된 캡슐을 자동으로 인식하고 캡슐마다 네스프레소의 최적화된 추출 레시피로 커피를 추출합니다.

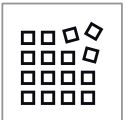
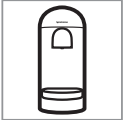

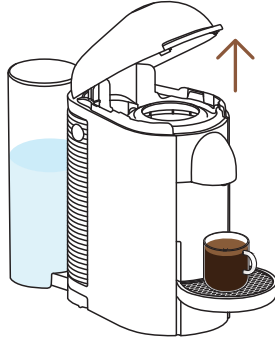

**6** 커피 추출이 끝나면, 머신 헤드를 열어 사용한 캡슐을 배출합니다. 머신의 헤드를 닫습니다.



**7** 네스프레소 캡슐을 재활용 하십시오.\*

\* THIS IS **NESPRESSO**. THIS IS RECYCLABLE. 캡슐 재활용에 관한 자세한 정보는 공식 **홈페이지**에서 확인하실 수 있습니다  
[www.nespresso.com](http://www.nespresso.com)



[www.nespresso.com](http://www.nespresso.com) 에서 에어로치노 제품군을 통해 커피 경험을 업그레이드하는 방법을 알아보십시오.

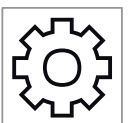
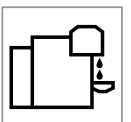
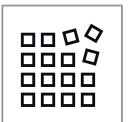

## 추출량 설정하기

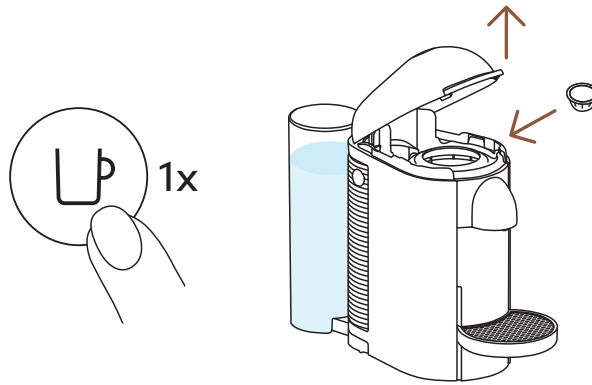

- 1** 버튼을 한번 눌러 머신의 전원을 켭니다. 머신 헤드를 열고 추출량을 설정할 캡슐을 넣습니다.

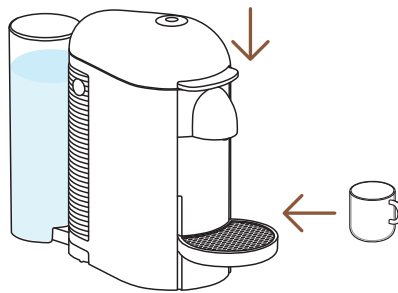

- 2** 머신 헤드를 닫고 커피 추출구 아래에 컵을 놓습니다.

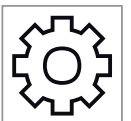
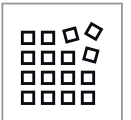

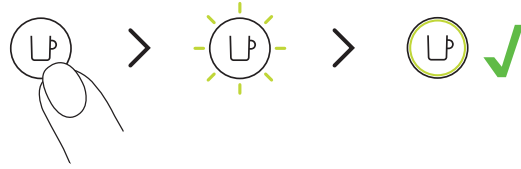

**3** 원하는 양이 추출되기 몇 초전까지 버튼을 계속 누르다가 손을 땁니다(커피 추출은 손을 떼고 몇 초간 더 추출되다가 멈춥니다). 이제 추출량을 다시 설정한 캡슐과 동일한 사이즈의 캡슐은 다시 설정한 추출량으로 추출이 됩니다.

**i** 설정된 추출량은 각 캡슐 사이즈에 따라 다르게 적용됩니다. 커피 추출량은 20 ml 부터 535 ml 까지 설정이 가능합니다

**중요:** 추출량을 설정하게 되면, 커피 종류에 관계 없이 동일한 사이즈의 캡슐을 추출할 때마다 설정한 추출량이 추출됩니다. 기본으로 설정된 추출량으로 되돌리려면, 공장 출하 설정값으로 초기화 부분을 참조하십시오.

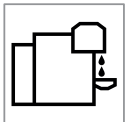
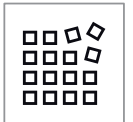

## 청소하기

머신을 장시간 사용하지 않았거나 머신 헤드 부분에 커피 찌꺼기가 남을 경우 1개월에 한 번씩 청소하십시오.

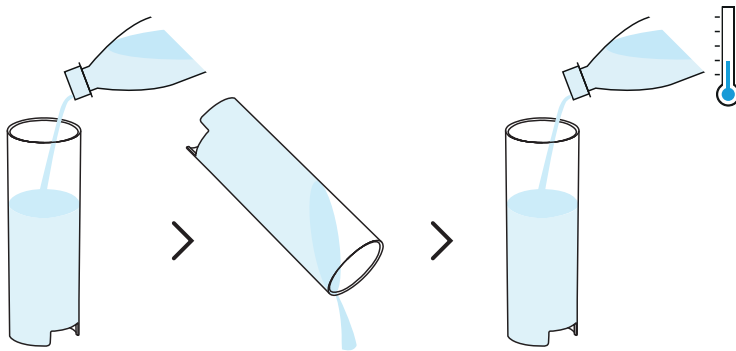

**1** 물통과 뚜껑을 깨끗한 물로 헹구고 깨끗한 음용수로 물통을 채웁니다.

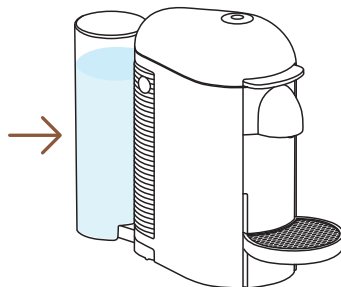

**2** 물통을 머신에 올바르게 장착합니다.

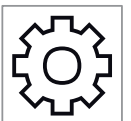
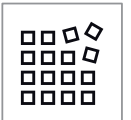

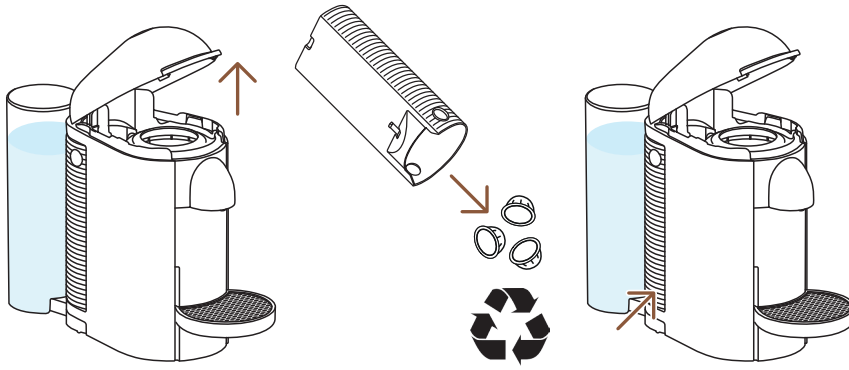

- 3** 머신의 전원이 켜진 상태로, 머신 헤드를 열어 사용한 캡슐을 배출합니다. 캡슐 컨테이너와 드립 트레이를 비우고 행군 후 다시 머신에 장착합니다. 네스프레소 캡슐을 재활용 하십시오.\*

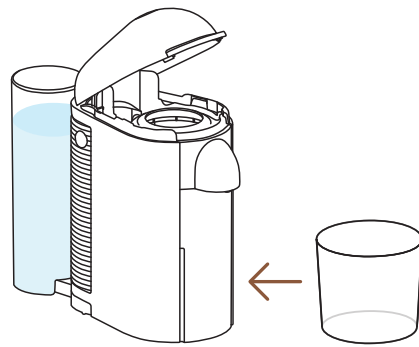

- 4** 컵 받침을 제거하고 커피 추출구 아래에 1 L 이상의 빈 용기를 놓습니다.

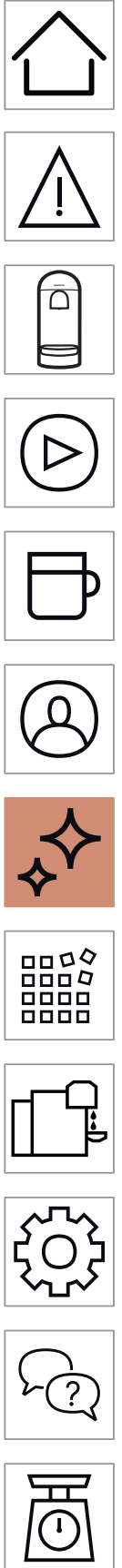

\* THIS IS **NESPRESSO**. THIS IS RECYCLABLE. 캡슐 재활용에 관한 자세한 정보는 공식 **홈페이지**에서 확인하실 수 있습니다  
[www.nespresso.com](http://www.nespresso.com)



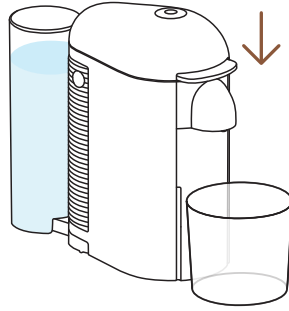

**5** 머신 헤드를 닫습니다.

**중요:** 머신이 예열되는 동안 녹색 불빛이 깜빡입니다. 머신은 약 40초 동안 예열됩니다. 녹색 불빛이 계속 켜져 있으면, 머신은 사용할 준비가 된 것입니다.

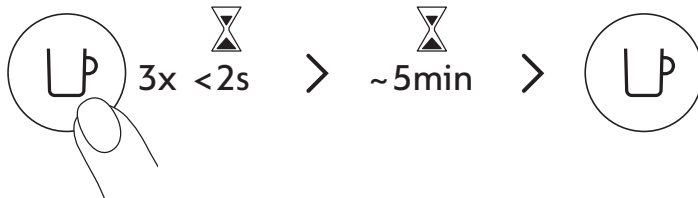

**6** 버튼을 2초 이내에 3번 누릅니다. 행굼 과정 진행 중 주황색 불빛이 깜빡이며, 자동으로 완료되도록 기다립니다.

**i** 행굼 과정을 시작하고 2분 이내에 커피 추출구로 뜨거운 물이 나오기 시작합니다. 행굼 과정은 최대 5분이 소요되며, 모든 과정이 완료되면 자동으로 종료됩니다. 행굼 중에 언제든지 버튼을 눌러 중단할 수 있습니다.



**7** 녹색 불빛이 계속 켜져 있으면, 머신은 사용할 준비가 된 것입니다.

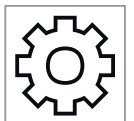
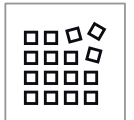

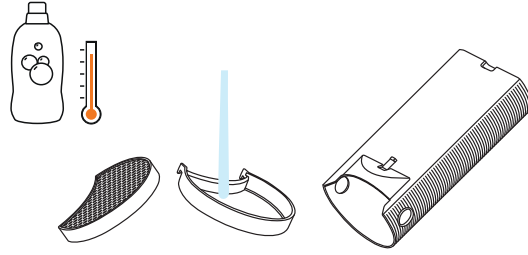

**8** 캡슐 컨테이너와 컵 받침을 따뜻한 물과 중성 세척제로 세척합니다.

**주의:** 강한 세제나 세척제는 절대 사용하지 마십시오. 절대 머신을 식기세척기에 넣지 마십시오. 절대 제품 또는 제품의 일부를 물이나 다른 액체에 담그지 마십시오.

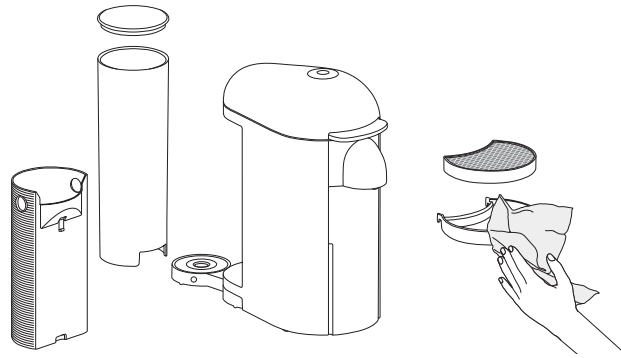

**9** 머신을 깨끗한 천으로 닦고 말립니다.

**주의:** 커피 추출구를 깨끗하고 젖은 천으로 매일 닦습니다. 머신을 청소할 때는 항상 깨끗하고 부드러운 천을 사용하십시오.

**중요:** 커피 추출 후 혹은 청소 모드 진행 후에 캡슐 투입구 안쪽에 물이 남을 수 있습니다. 깨끗한 마른 천으로 닦아주세요.

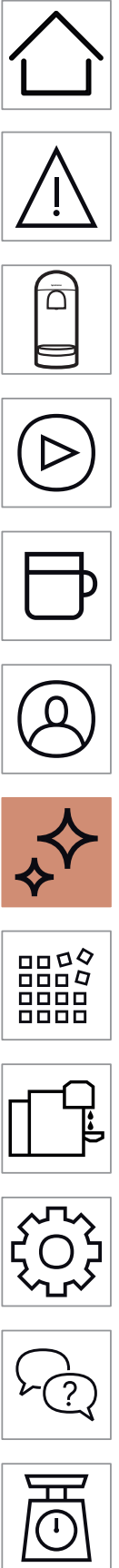

## 디스케일링

적기에 디스케일링을 수행하면, 적절한 머신의 작동 및 새 머신과 같은 커피 품질을 유지할 수 있습니다. 왼쪽에는 빨간색, 오른쪽에는 녹색 불빛이 켜지면, 디스케일링이 필요하다는 알림입니다.



**i** 디스케일링은 최대 20분이 소요되며 도중에 중단할 경우 처음부터 다시 진행해야 합니다.

**중요:** 디스케일링 과정을 시작하기 전에 설명서와 안전 수칙을 주의 깊게 읽으십시오.

### 필요한 도구:

- 디스케일링 키트는 [www.nespresso.com](http://www.nespresso.com)에서 구매 가능합니다. (한국 네스프레소에서 디스케일링 키트를 판매하지 않습니다. 깨끗한 물로만 디스케일링을 진행하여 주십시오.)
- 1 L 이상의 빈 용기

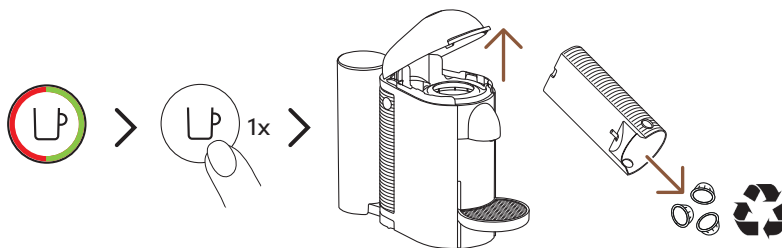

**1** 왼쪽에는 빨간색, 오른쪽에는 녹색 불빛이 켜져 있는 경우: 머신의 전원이 켜진 상태로, 머신 헤드를 열고 사용한 캡슐을 배출합니다. 캡슐 컨테이너를 비우고 다시 머신에 장착합니다. 네스프레소 캡슐을 재활용 하십시오.\*

\* THIS IS NESPRESSO. THIS IS RECYCLABLE. 캡슐 재활용에 관한 자세한 정보는 공식 **홈페이지**에서 확인하실 수 있습니다  
[www.nespresso.com](http://www.nespresso.com)

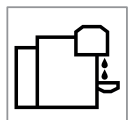
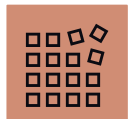

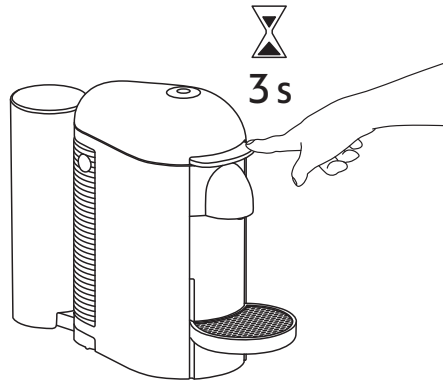

- 2** 머신 헤드를 닫고 레버를 아래 방향으로 3초간 눌러 머신의 전원을 끕니다.

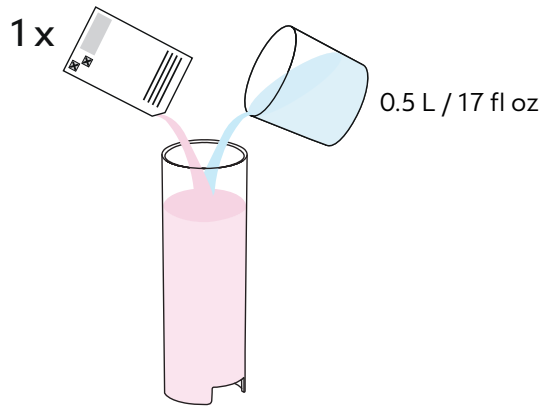

- 3** 물통에 네스프레소 디스케일링 용액 1개와 최소 0.5 L 이상의 물을 넣습니다. (한국 네스프레소에서 디스케일링 키트를 판매하지 않습니다. 깨끗한 물로만 디스케일링을 진행하여 주십시오.)

**주의:** 디스케일링 용액은 유해할 수 있습니다. 눈이나 피부에 닿지 않도록 주의하여 주십시오.

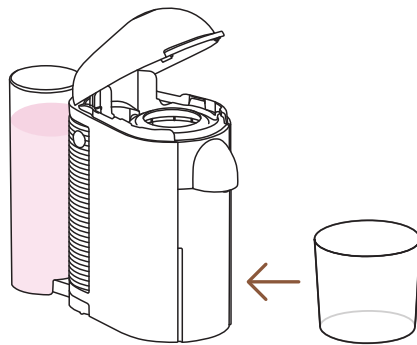

- 4** 컵 받침을 제거하고 커피 추출구 아래에 1 L 이상의 빈 용기를 놓습니다.

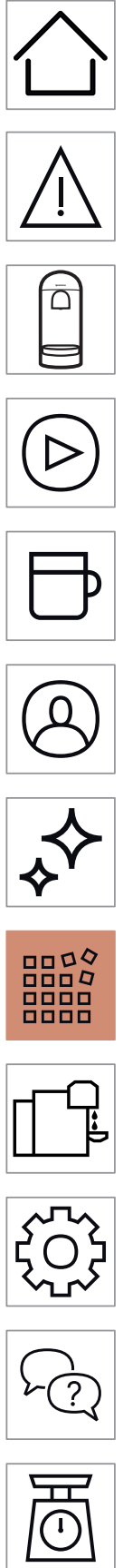

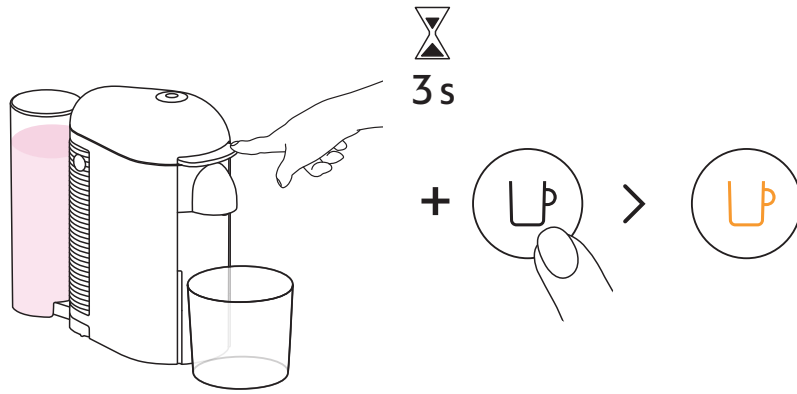

**5** 버튼과 레버를 동시에 3초 이상 누릅니다. 주황색 불빛으로 특별 기능 메뉴에 들어온 것을 확인합니다.

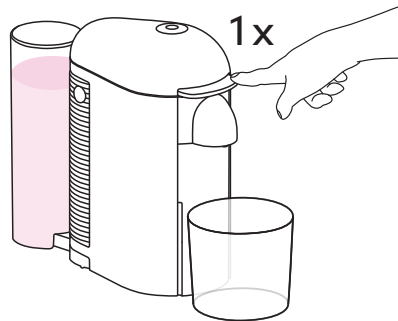

**6** 디스케일링 모드에 진입하려면, 레버를 아래로 한번 누릅니다.

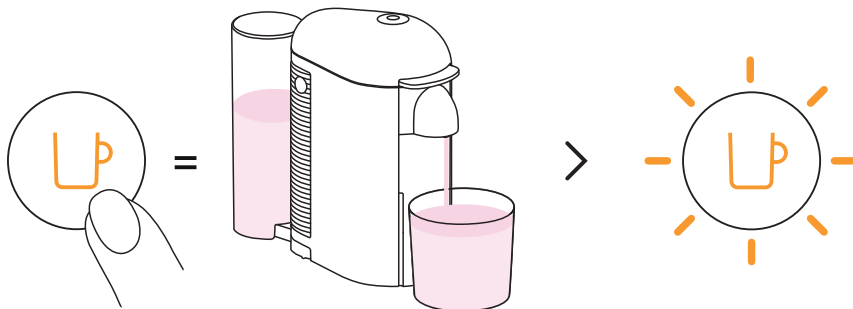

**7** 버튼을 한번 누릅니다.

**i** 디스케일링 과정 동안 버튼이 주황색으로 깜빡입니다. 첫 번째 디스케일링 과정이 완료되면 머신이 자동으로 멈춥니다.

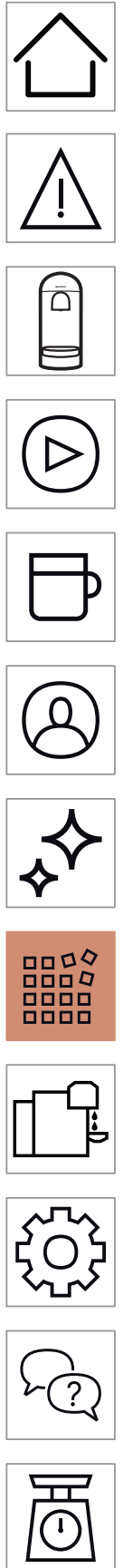

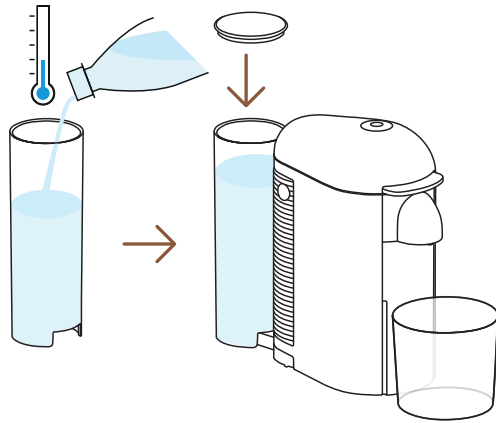

- 8** 첫 번째 디스케일링 과정이 끝나면, 행굼 과정을 진행해야 합니다. 물통과 드립 트레이를 깨끗하게 행굼니다. 깨끗한 음용수로 물통을 가득 채우고 물통을 머신에 올바르게 장착합니다. 커피 추출구 아래의 용기를 비우고 다시 놓습니다.

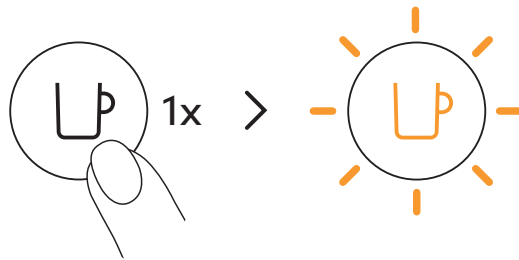

- 9** 버튼을 한번 눌러 행굼 과정을 시작합니다. 행굼 과정이 자동으로 완료되도록 기다립니다. 행굼 과정 동안 버튼이 주황색으로 깜빡입니다. 행굼 과정을 시작하고 2초 이내에 커피 추출구로 뜨거운 물이 나오기 시작합니다.

- i** 행굼 과정은 최대 5분이 소요되며, 모든 과정이 완료되면 자동으로 종료됩니다. 행굼 중에 언제든지 버튼을 눌러 중단할 수 있습니다.



- 10** 불빛이 녹색으로 돌아오면, 행굼 과정이 완료된 것입니다.

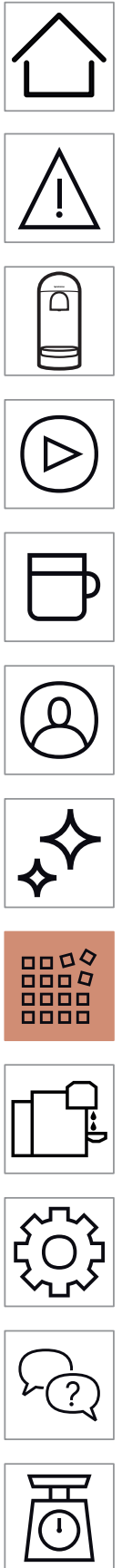

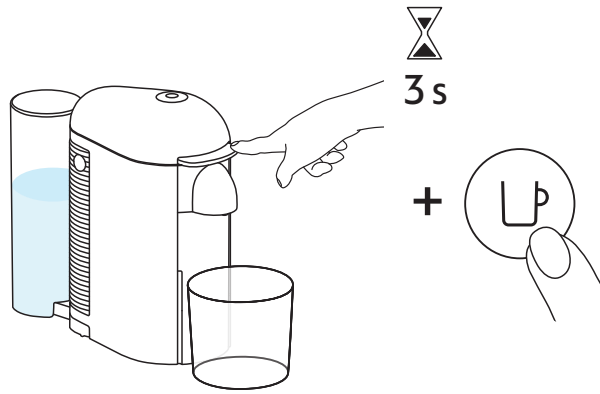

**11** 버튼과 레버를 아래 방향으로 3초간 동시에 눌러 디스케일링 모드에서 나갑니다.

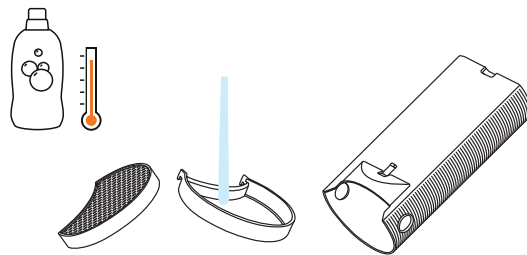

**12** 캡슐 컨테이너 및 컵 받침을 따뜻한 물과 중성 세척제로 세척합니다.

**주의:** 강한 세제나 세척제는 절대 사용하지 마십시오. 절대 머신을 식기세척기에 넣지 마십시오. 절대 제품 또는 제품의 일부를 물이나 다른 액체에 담그지 마십시오.

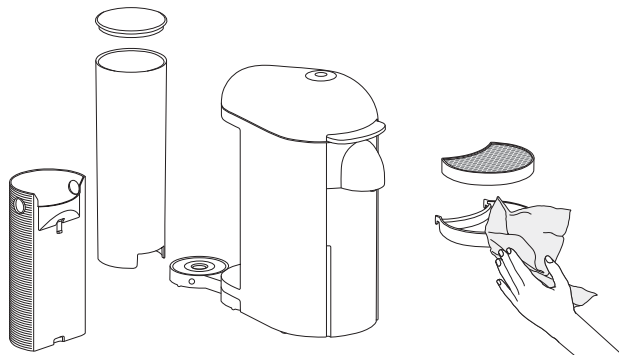

**13** 머신을 깨끗한 천으로 닦고 말립니다. 머신을 사용하기 전에 10분간 말립니다.

**중요:** 청소 과정 중 캡슐 투입구 안쪽에 물이 남을 수 있습니다. 깨끗하고 마른 천으로 보이는 부분을 닦아주세요.

**중요:** 버추오 플러스 머신은 최소 30회 이상 커피를 추출한 후에 디스케일링 모드를 진행할 수 있습니다. 추출하지 않은 새 머신은 디스케일링을 진행할 수 없습니다.

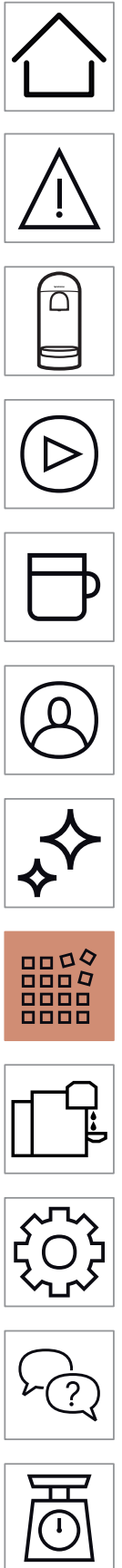

## 머신 내부의 물 비우기

머신 내부의 물 비우기는 장기간 사용 계획이 없는 경우, 동파 방지를 위해 또는 수리 보내기 전에 해야하는 과정입니다.

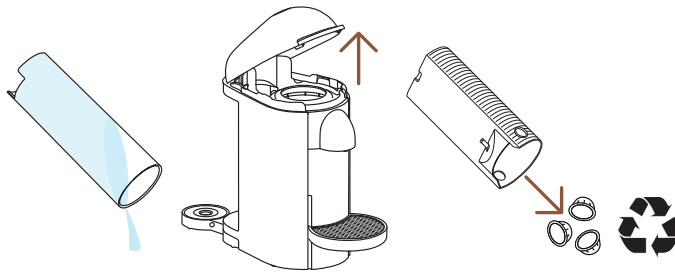

- 1** 머신의 전원이 켜진 상태로, 물통을 비우고 머신 헤드를 열어 사용한 캡슐을 배출합니다. 캡슐 컨테이너를 비웁니다. 네스프레소 캡슐을 재활용 하십시오.\*

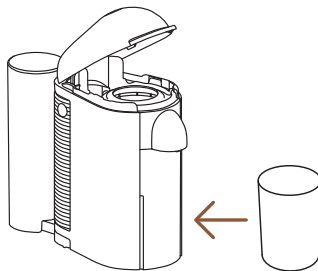

- 2** 다시 부품들을 머신에 장착하고, 컵 받침을 제거합니다. 커피 추출구 아래에 0.5 L 이상의 빈 용기를 놓습니다.

\* THIS IS **NESPRESSO**. THIS IS RECYCLABLE. 캡슐 재활용에 관한 자세한 정보는 공식 **홈페이지**에서 확인하실 수 있습니다  
[www.nespresso.com](http://www.nespresso.com)





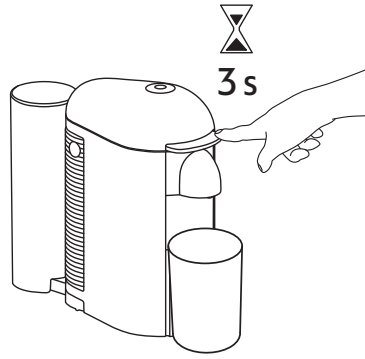

- 3** 머신 헤드를 닫고 레버를 아래 방향으로 3초 이상 눌러 머신의 전원을 끕니다.

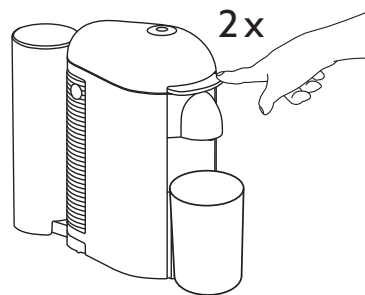

- 4** 레버를 아래 방향으로 2번 누릅니다.

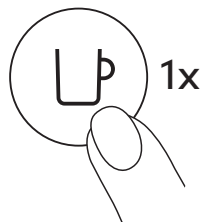

- 5** 버튼을 한번 누릅니다.

- i** 비우기 과정은 약 30초가 소요됩니다. 모든 과정이 완료되면 자동으로 머신의 전원이 꺼집니다.

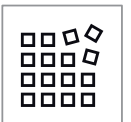

## 공장 출하 설정값으로 초기화

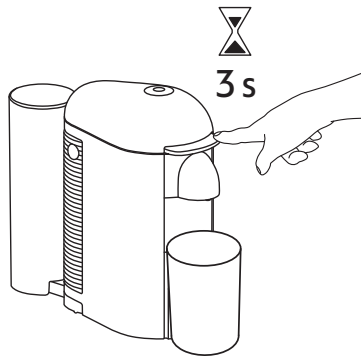

- 1** 머신의 전원 플러그를 연결하고, 레버를 아래 방향으로 3초 이상 눌러 머신의 전원을 끕니다.

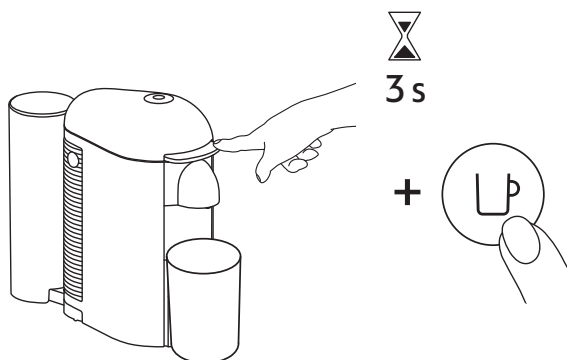

- 2** 버튼과 레버를 동시에 3초 이상 누릅니다.

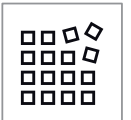

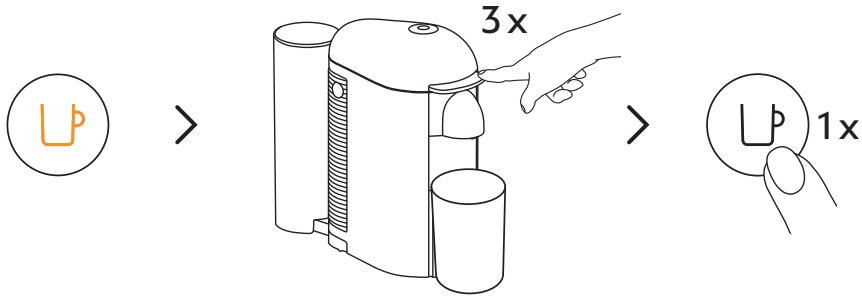

- 3** 주황색 불빛으로 특별 기능 메뉴에 들어온 것을 확인합니다. 그 다음 레버를 3회 누르고 버튼을 1회 눌러 공장 출하 설정값으로 초기화를 선택합니다.

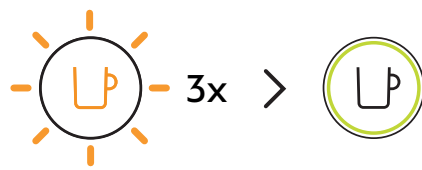

- 4** 주황색 불빛이 3초 동안 3번 깜빡이며 공장 출하 설정값으로 초기화 됨을 확인 한 후 다시 녹색 불빛이 켜집니다. 공장 출하 설정값으로 초기화가 완료 되었습니다

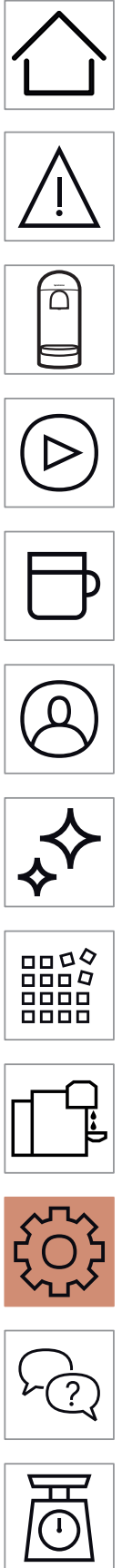

## 문제 해결

버튼에 불빛이 들어오지 않습니다.

- 머신이 자동으로 꺼졌을 경우: 버튼을 누르거나 레버를 올리거나 내려 다시 전원을 켭니다.
- 전원 플러그, 전압, 퓨즈를 확인합니다.

커피와 물이 추출되지 않습니다.

- 물통에 물이 채워져 있고 올바르게 장착되어 있는지 확인합니다.
- 새 캡슐이 제대로 장착되어 있고 헤드가 닫혀있는지 확인합니다.
- 필요 시 디스케일링을 진행합니다.
- 머신의 헤드를 열어 캡슐을 배출한 후, 청소하기 부분을 참고하여 청소를 진행합니다.

커피가 충분히 뜨겁지 않습니다.

- 따뜻한 물로 컵을 데운 후 사용합니다.
- 필요 시 디스케일링을 진행합니다.

누수가 발생하거나 커피 추출이 원활하지 않습니다.

- 물통이 제대로 장착되어 있는지 확인합니다.
- 필요 시 디스케일링을 진행 합니다.

머신의 전원이 꺼집니다.

- 에너지 절전을 위해 9분 동안 머신을 사용하지 않으면 자동으로 전원이 꺼집니다.
- 머신을 사용하지 않을 경우 레버를 3초간 눌러 머신의 전원을 끌 수 있습니다,

컵에 많은 양의 커피 가루가 나옵니다.

- 청소 과정을 2회 진행합니다.
- 청소하기 부분을 참고하십시오.

커피가 누수됩니다.

- 머신 헤드를 열어 캡슐을 배출합니다. 청소하기 부분을 참고하여 머신을 청소합니다.
- 컵 받침을 비우고 세척합니다.
- 필요 시 디스케일링을 진행합니다.
- 만약 문제가 지속되면 네스프레소 클럽으로 연락하십시오.

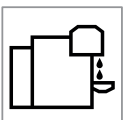

## 제품 사양

|                         |   |
|-------------------------|---|
| <b>전력</b>               | ~220-240 V, 50-60 Hz, 1260 W<br>US, CA: 120 V, 60 Hz, 1300 W<br>MX: 127 V, 60 Hz, 1520 W<br>BR, KR: 220 V, 60 Hz, 1150 W  |
| <b>에너지 절약 모드</b>        | 자동 꺼짐 : 9분  |
| <b>예열 시간</b>            | 40초   |
| <b>높이 조절이 가능한 컵 받침</b>  | 조정 가능   |
| <b>머신의 케이블 길이</b>       | 78 cm / 30 in   |
| <b>크기 (폭 x 깊이 x 높이)</b> | <p><b>물통을 옆으로 돌릴 경우</b></p> <ul style="list-style-type: none"> <li>• 화이트, 매트 블랙 모델: 22 x 34.9 x 32.5 cm / 8.7 x 13.7 x 12.8 in</li> <li>• 실버, 블랙 모델: 23.2 x 35.9 x 32.5 cm / 9.1 x 14.1 x 12.8 in</li> </ul> <p><b>물통을 뒤쪽으로 할 경우</b></p> <ul style="list-style-type: none"> <li>• 화이트, 매트 블랙 모델: 14.2 x 41.2 x 32.5 cm / 5.6 x 16.2 x 12.8 in</li> <li>• 실버, 블랙 모델: 14.2 x 42.3 x 32.5 cm / 5.6 x 16.7 x 12.8 in</li> </ul> |
| <b>무게</b>               | 4.3 ~ 4.6 kg (디자인에 따라 다름)   |
| <b>물통 용량</b>            | 화이트, 매트 블랙 모델: 1.2 L / 40 fl oz<br>실버, 블랙 모델: 1.8 L / 60 fl oz  |
| <b>캡슐 컨테이너 용량</b>       | 에스프레소 14 캡슐 또는 머그 10 캡슐   |

## 제품 모델명

| Nespresso  | Breville                          | Delonghi |
|------------|-----------------------------------|----------|
| GCB2, GDB2 | BNV320, BNV350,<br>BNV420, BNV450 | ENV155   |
| Krups      | Magimix                           |          |
| XN900      | M600                              |          |

